

TRUCK SPARE PARTS

Gesuchte Europäische Qualität

OIL - FUEL TANKS

sought-after  
quality

# OIL-FUEL TANKS



**KLÖTZE**  
TECHNIC

[www.klotzetechnik.de](http://www.klotzetechnik.de)

**Klötze Technic** ist ein in Deutschland ansässiger Hersteller und Lieferant von LKW-, Anhänger- und Bus-Ersatzteilen.



**KLÖTZE**  
TECHNIC

Gesuchte Europäische  
**Qualität**

Klötze Technic is a Germany-based company specializing in truck, trailer, and bus spare parts. Together with our sales office in Turkey, we provide our customers with original spare parts of guaranteed quality. Our products are manufactured with superior German engineering.

Our main groups consist of Engine, Cooling System, Fuel System, Exhaust System, Clutch & Pedal, Gearbox, Propeller Shaft, Axles, Brake System, Hubs & Wheels, Suspension, Steering, Electrical System, Cabin, and Body.

At Klötze Technic, we strive to provide our customers with the highest quality products, competitive prices, and superior customer service.

#### **Our Mission:**

At Klötze Technic, we work to provide our customers with the highest quality and reliable spare parts for trucks, trailers, and buses.

Our high-quality products are manufactured with superior German engineering.

Our mission is to meet our customers' needs and provide them with the best customer service possible.

#### **Our Vision:**

At Klötze Technic, we aim to become a world-leading company in the field of truck, trailer, and bus spare parts.

Our vision is to provide our customers with the highest quality products, competitive prices, and superior customer service. In doing so, we aim to meet our customers' needs and ensure their satisfaction.

#### **Our Quality Policy:**

At Klötze Technic, quality and customer satisfaction are always our top priorities. Our products are manufactured with superior German engineering and are provided to our customers as original spare parts of guaranteed quality. Our quality policy is to provide our customers with the best quality products and meet their needs in the best way possible.

Customer satisfaction is always important to us.

**TRUCK SPARE PARTS**



**KLÖTZE**  
TECHNIC

Gesuchte Europäische  
**Qualität**



**TRUCK SPARE PARTS**

[www.klotzetechnik.de](http://www.klotzetechnik.de)



**KLÖTZE**  
TECHNIC

ALUMINIUM  
FUEL TANKS  
42X52



**Mitsubishi - Mercedes**  
**Isuzu - Hino - Atego**

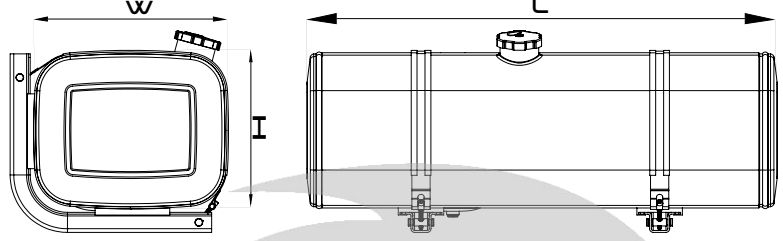

Seri No Serial No	Yükseklik (mm) Height (mm)	Genişlik (mm) Width (mm)	Uzunluk (mm) Length (mm)	Hacim (lt) Capacity (lt)
KT 4252 050	420	520	500	90
KT 4252 085	420	520	850	160
KT 4252 110	420	520	1100	210
KT 4252 135	420	520	1350	260
KT 4252 160	420	520	1600	310
KT 4252 185	420	520	1850	360

**MONTAJ KITI / MOUNTING KIT**



Çelik  
Steel

**201009**  
Ayak/Bracket

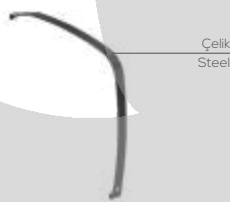

Çelik  
Steel

**202468**  
Kuşak/Strap

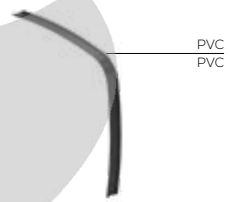

PVC  
PVC

**001690**  
Kuşak Lastiği/Strap Rubber

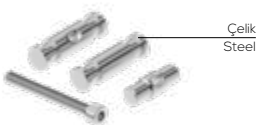

Çelik  
Steel

**201302**  
Pim Takımı/Pim Sets



PVC  
PVC

**000956**  
Depo Kapağı/Tank Cap



PVC  
PVC

**001557**  
Ayak Takozu/Bracket Rubber



Oem numbers are only for comparison and must not be mentioned on invoices



**KLÖTZE**  
TECHNIC

ALUMINIUM  
FUEL  
TANKS  
41X64



**Universal**

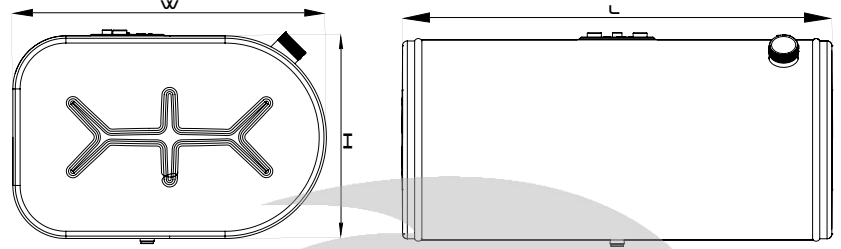

Seri No Serial No	Yükseklik (mm) Height (mm)	Genişlik (mm) Width (mm)	Uzunluk (mm) Length (mm)	Hacim (lt) Capacity (lt)
KT 4164 088	410	640	885	210



# KLÖTZE TECHNIC

## ALUMINIUM FUEL TANKS 56X64



### Mercedes

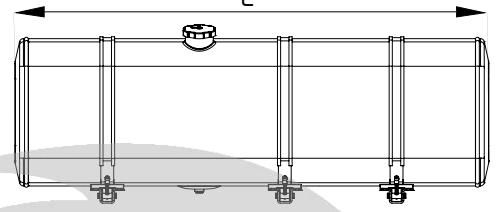
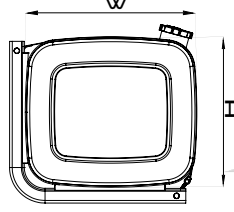

Seri No Serial No	Orijinal Kod OEM Code	Yükseklik (mm) Height (mm)	Genişlik (mm) Width (mm)	Uzunluk (mm) Length (mm)	Hacim (lt) Capacity (lt)
KT 5664 073	A942.470.0101	560	640	730	230
KT 5664 094	A942.470.0201	560	640	940	300
KT 5664 125	A942.470.0401	560	640	1250	400
KT 5664 155	A942.470.0501	560	640	1550	500
KT 5664 180	A942.470.0601	560	640	1800	600
KT 5664 200	A941.470.1701	560	640	2000	700

### MONTAJ KITI / MOUNTING KIT



Çelik  
Steel

**201304**  
Ayak/Bracket



Çelik  
Steel

**200073**  
Kuşak/Strap

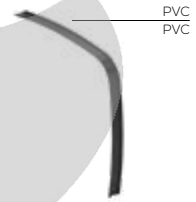

PVC  
PVC

**200074**  
Kuşak Lastiği/Strap Rubber

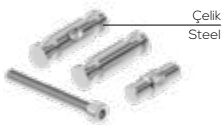

Çelik  
Steel

**201767**  
Pim Takımı/Pim Sets



PVC  
PVC

**00956**  
Depo Kapağı/Tank Cap

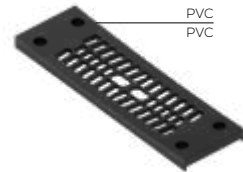

PVC  
PVC

**001555**  
Ayak Takoğu/Bracket Rubber



**KLÖTZE**  
TECHNIC

ALUMINIUM  
FUEL  
TANKS

**56X67**

**Volvo - Renault**

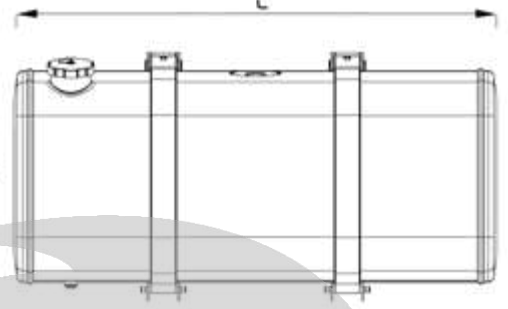
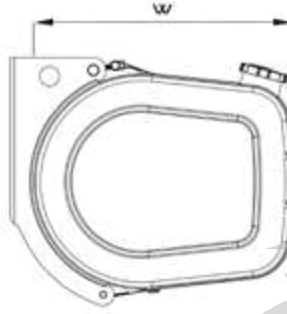

Seri No Serial No	Orijinal Kod OEM Code	Yükseklik (mm) Height (mm)	Genişlik (mm) Width (mm)	Uzunluk (mm) Length (mm)	Hacim (lt) Capacity (lt)
KT 5667 103	20504488	560	670	1030	315
KT 5667 123	20504489	560	670	1230	380
KT 5667 133	20452163	560	670	1330	415
KT 5667 143	21516477	560	670	1430	445
KT 5667 173	20504494	560	670	1730	540
KT 5667 203	20504495	560	670	2030	630

**MONTAJ KITI / MOUNTING KIT**



Çelik  
Steel

**202481**  
Ayak/Bracket



Çelik  
Steel

**202480**  
Kuşak/Strap



PVC  
PVC

**002173**  
Kuşak Lastiği/Strap Rubber

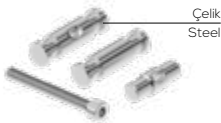

Çelik  
Steel

**201766**  
Pim Takımı/Pim Sets



PVC  
PVC

**00956**  
Depo Kapağı/Tank Cap



PVC  
PVC

**002174**  
Ayak Takoğu/Bracket Rubber



**KLÖTZE**  
TECHNIC

# ALUMINIUM FUEL TANKS 62X67

Man - Daf - Iveco

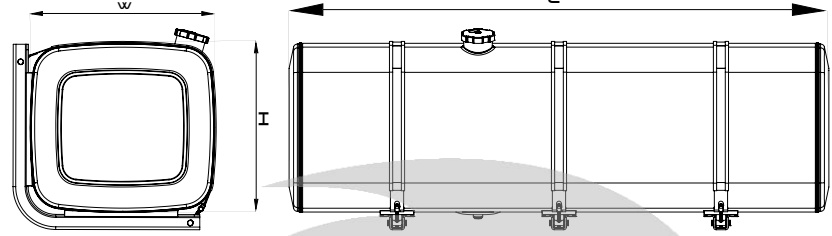

Seri No Serial No	Orijinal Kod OEM Code	Yükseklik (mm) Height (mm)	Genişlik (mm) Width (mm)	Uzunluk (mm) Length (mm)	Hacim (lt) Capacity (lt)
KT 6267 070	81.12201-5653	620	675	700	250
KT 6267 082	81.12201-5469	620	675	820	300
KT 6267 107	81.12201-5656	620	675	1070	400
KT 6267 135	81.12201-5657	620	675	1350	500
KT 6267 160	81.12201-5664	620	675	1600	600
KT 6267 185	81.12201-5673	620	675	1850	700
KT 6267 200	81.12201-5523	620	675	2000	750
KT 6267 208	81.12201-5674	620	675	2080	780
KT 6267 215	81.12201-5671	620	675	2150	850

## MONTAJ KITI / MOUNTING KIT



Çelik  
Steel

**201306**  
Ayak/Bracket

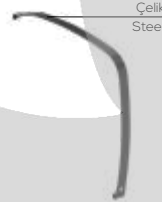

Çelik  
Steel

**200024**  
Kuşak/Strap

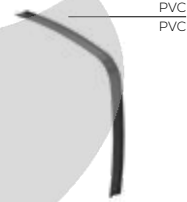

PVC  
PVC

**200023**  
Kuşak Lastiği/Strap Rubber

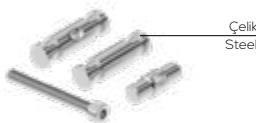

Çelik  
Steel

**201767**  
Pim Takımı/Pim Sets



PVC  
PVC

**000956**  
Depo Kapağı/Tank Cap

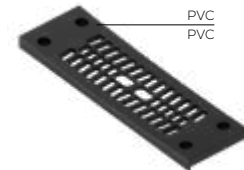

PVC  
PVC

**001555**  
Ayak Takozu/Bracket Rubber



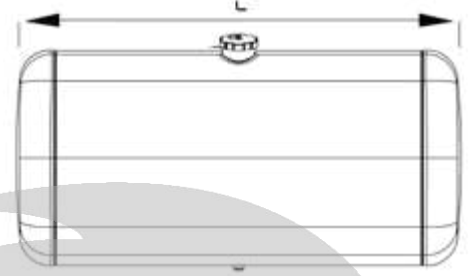
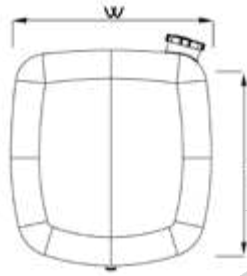

Seri No Serial No	Orijinal Kod OEM Code	Yükseklik (mm) Height (mm)	Genişlik (mm) Width (mm)	Uzunluk (mm) Length (mm)	Hacim (lt) Capacity (lt)
KT 6570 85	A9604705502	700	650	850	320
KT 6570 110	A9604705702	700	650	1100	420
KT 6570 130	A9604705802	700	650	1300	500
KT 6570 145	A9604705902	700	650	1450	550
KT 6570 160	A9604706002	700	650	1600	600
KT 6570 225		700	650	2250	850



**KLÖTZE**  
TECHNIC

ALUMINIUM  
FUEL  
TANKS  
62X67

Man

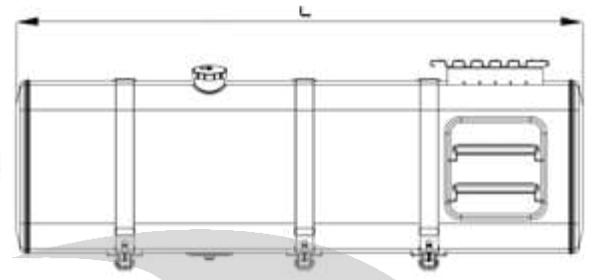
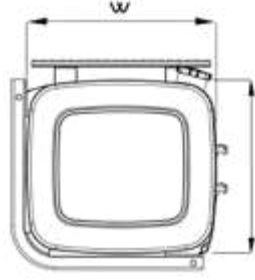

Seri No Serial No	Yükseklik (mm) Height (mm)	Genişlik (mm) Width (mm)	Uzunluk (mm) Length (mm)	Hacim (lt) Capacity (lt)
KT 6267 200	620	675	2000	750
KT 6267 205	620	675	2050	780
KT 6267 210	620	675	2100	800

MONTAJ KITI / MOUNTING KIT



**201306**  
Ayak/Bracket



**200024**  
Kuşak/Strap

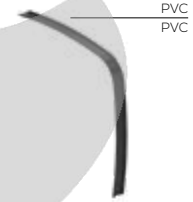

**200023**  
Kuşak Lastiği/Strap Rubber

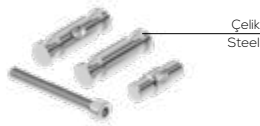

**201767**  
Pim Takımı/Pim Sets

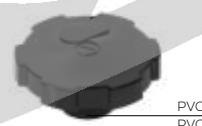

**000956**  
Depo Kapağı/Tank Cap

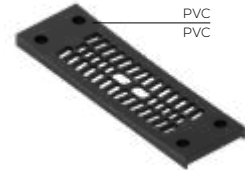

**001555**  
Ayak Takozu/Bracket Rubber

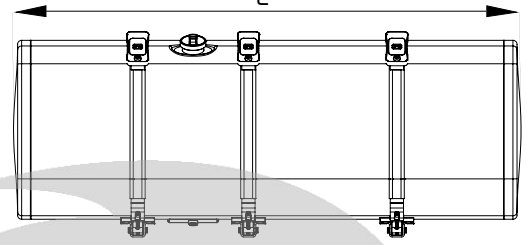
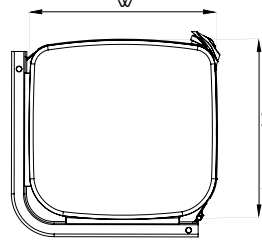

Seri No Serial No	Orijinal Kod OEM Code	Yükseklik (mm) Height (mm)	Genişlik (mm) Width (mm)	Uzunluk (mm) Length (mm)	Hacim (lt) Capacity (lt)
KT 6770 039	1517311	670	700	390	150
KT 6770 041	1517303	670	700	415	175
KT 6770 073	1517304	670	700	730	300
KT 6770 086	1517305	670	700	860	350
KT 6770 100	1544778	670	700	1000	400
KT 6770 119	1517306	670	700	1190	470
KT 6770 126	1517307	670	700	1260	500
KT 6770 151	1517308	670	700	1510	600
KT 6770 162	1780854	670	700	1620	700

**MONTAJ KITI / MOUNTING KIT**

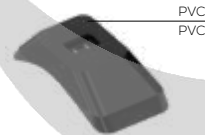
**201306**  
 Ayak/Bracket

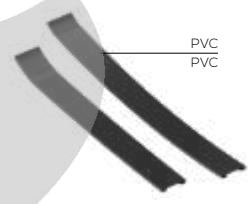
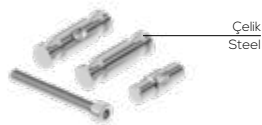
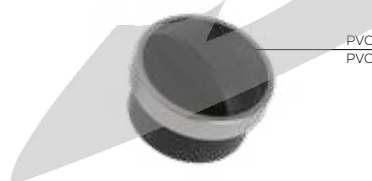
**001007**  
 Kuşak Kapağı/Strap Cap

**201221 - 201222**  
 Kuşak/Strap

**201219 - 201220**  
 Kuşak Lastiği/Strap Rubber

**201905**  
 Pim Takımı/Pim Sets

**000691**  
 Depo Kapağı/Tank Cap

**001555**  
 Ayak Takoğu/Bracket Rubber



**KLÖTZE**  
TECHNIC

ALUMINIUM  
FUEL  
TANKS  
**69X69**

**Mercedes**

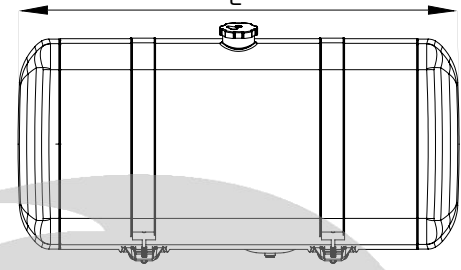
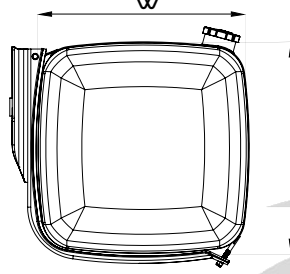

Seri No Serial No	Orijinal Kod OEM Code	Yükseklik (mm) Height (mm)	Genişlik (mm) Width (mm)	Uzunluk (mm) Length (mm)	Hacim (lt) Capacity (lt)
KT 6969 065	A 942 470 1601	690	690	650	280
KT 6969 076	A 942 470 1001	690	690	760	300
KT 6969 090	A 942 470 1301	690	690	900	400
KT 6969 107	A 942 470 1101	690	690	1070	450
KT 6969 123	A 942 470 1401	690	690	1230	550
KT 6969 150	A 942 470 0001	690	690	1500	650
KT 6969 175		690	690	1750	780
KT 6969 200		690	690	2000	900
KT 6969 225	A 934 470 1101	690	690	2250	980

**MONTAJ KITI / MOUNTING KIT**



Çelik  
Steel

**200648**  
Ayak/Bracket



Çelik  
Steel

**200642**  
Kuşak/Strap

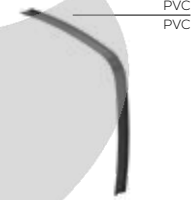

PVC  
PVC

**000297**  
Kuşak Lastiği/Strap Rubber

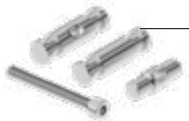

Çelik  
Steel

**204431**  
Pim Takımı/Pim Sets



PVC  
PVC

**000956**  
Depo Kapağı/Tank Cap

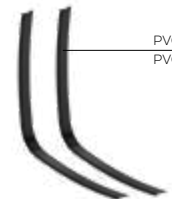

PVC  
PVC

**000326**  
Ayak Takozu/Bracket Rubber



**KLÖTZE**  
TECHNIC

ALUMINIUM  
FUEL  
TANKS  
**69X69**

**Mercedes**

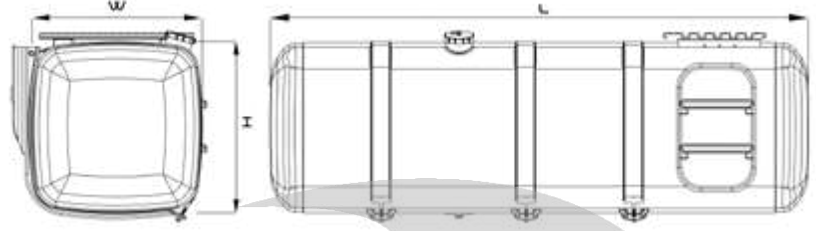

Seri No Serial No	Yükseklik (mm) Height (mm)	Genişlik (mm) Width (mm)	Uzunluk (mm) Length (mm)	Hacim (lt) Capacity (lt)
KT 6969 210	690	690	2100	790
KT 6969 225	690	690	2250	900

**MONTAJ KITI / MOUNTING KIT**



**200648**  
Ayak/Bracket



**200642**  
Kuşak/Strap

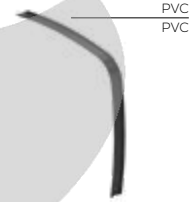

**000297**  
Kuşak Lastiği/Strap Rubber

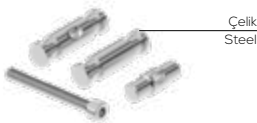

**204431**  
Pim Takımı/Pim Sets



**000956**  
Depo Kapağı/Tank Cap

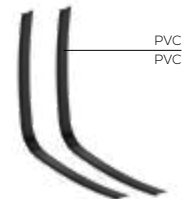

**000326**  
Ayak Takozu/Bracket Rubber



**KLÖTZE**  
TECHNIC

ALUMINIUM  
FUEL  
TANKS  
69X71



**Volvo - Renault**

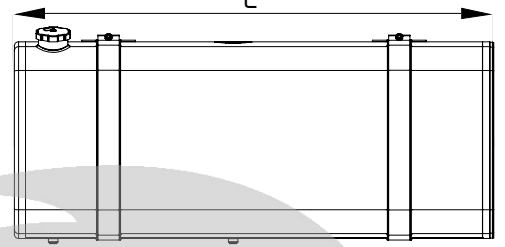
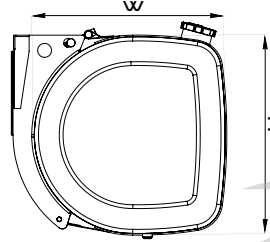

Seri No Serial No	Orijinal Kod OEM Code	Yükseklik (mm) Height (mm)	Genişlik (mm) Width (mm)	Uzunluk (mm) Length (mm)	Hacim (lt) Capacity (lt)
KT 6971 043	20503502	690	710	430	165
KT 6971 053	20503503	690	710	530	205
KT 6971 071	24425785	690	710	710	280
KT 6971 083	20503504	690	710	830	325
KT 6971 093	20507744	690	710	930	360
KT 6971 103	20503505	690	710	1030	400
KT 6971 113	20503506	690	710	1130	445
KT 6971 123	20503507	690	710	1230	485
KT 6971 133	20503508	690	710	1330	530
KT 6971 143	20503509	690	710	1430	565
KT 6971 153	20503510	690	710	1530	605
KT 6971 163	20503511	690	710	1630	645
KT 6971 173	20503514	690	710	1730	685
KT 6971 183	20503516	690	710	1830	725
KT 6971 203	20503517	690	710	2030	805

**MONTAJ KITI / MOUNTING KIT**



Çelik  
Steel



Çelik  
Steel

PVC  
PVC

**203980**  
Ayak/Bracket

**203985**  
Kuşak/Strap

**002024**  
Kuşak Lastiği/Strap Rubber

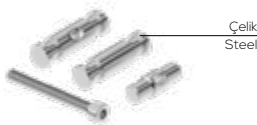

Çelik  
Steel



PVC  
PVC

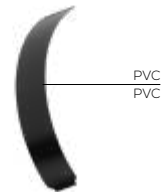

PVC  
PVC

**204432**  
Pim Takımı/Pim Sets

**000956**  
Depo Kapağı/Tank Cap

**002025**  
Ayak Takoğu/Bracket Rubber



**KLÖTZE**  
TECHNIC

ALUMINIUM  
FUEL  
TANKS  
71X71

Man - Daf - Iveco

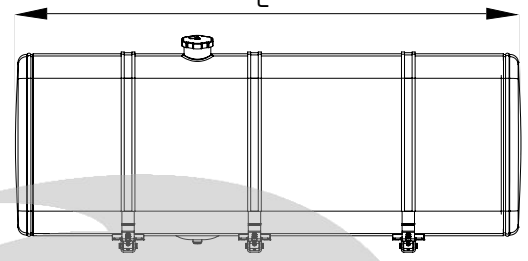
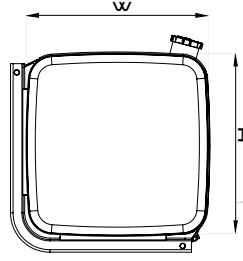

Seri No Serial No	Orijinal Kod OEM Code	Yükseklik (mm) Height (mm)	Genişlik (mm) Width (mm)	Uzunluk (mm) Length (mm)	Hacim (lt) Capacity (lt)
KT 7171 068	81122015715	710	710	680	300
KT 7171 087	1949905	710	710	875	370
KT 7171 093	1949906	710	710	930	400
KT 7171 106	81122015828	710	710	1060	450
KT 7171 113	1949909	710	710	1130	490
KT 7171 121	1949910	710	710	1210	525
KT 7171 136	1949961	710	710	1360	580
KT 7171 143	1949806	710	710	1430	605
KT 7171 148	1949912	710	710	1485	640
KT 7171 163	2041734	710	710	1630	700
KT 7171 177		710	710	1770	800
KT 7171 188	1949915	710	710	1880	820
KT 7171 211	1944799	710	710	2115	875
KT 7171 224	1949917	710	710	2240	1000

MONTAJ KITI / MOUNTING KIT



Çelik  
Steel

**201305**  
Ayak/Bracket



Çelik  
Steel

**200050**  
Kuşak/Strap

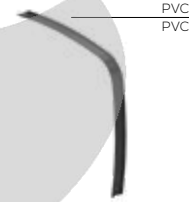

PVC  
PVC

**200284**  
Kuşak Lastiği/Strap Rubber

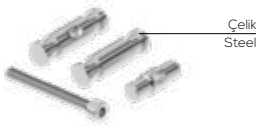

Çelik  
Steel

**201767**  
Pim Takımı/Pim Sets



PVC  
PVC

**000956**  
Depo Kapağı/Tank Cap

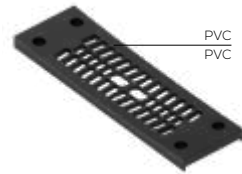

PVC  
PVC

**001555**  
Ayak Takozu/Bracket Rubber



**KLÖTZE**  
TECHNIC

ALUMINIUM  
FUEL  
TANKS  
73X73

Universal

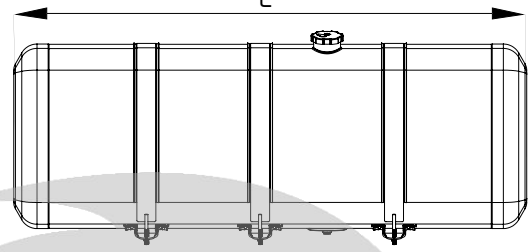
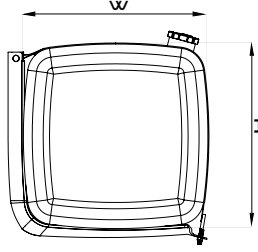

Seri No Serial No	Yükseklik (mm) Height (mm)	Genişlik (mm) Width (mm)	Uzunluk (mm) Length (mm)	Hacim (lt) Capacity (lt)
KT 7373 084	730	730	840	400
KT 7373 105	730	730	1050	495
KT 7373 120	730	730	1200	580
KT 7373 153	730	730	1530	745
KT 7373 178	730	730	1780	865
KT 7373 182	730	730	1820	885
KT 7373 203	730	730	2030	990

MONTAJ KITI / MOUNTING KIT



Çelik  
Steel

**204451**  
Ayak/Bracket



Çelik  
Steel

**204452**  
Kuşak/Strap

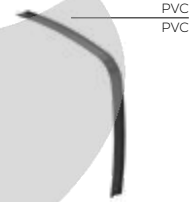

PVC  
PVC

**000297**  
Kuşak Lastiği/Strap Rubber



Çelik  
Steel

**204453**  
Pim Takımı/Pin Sets



PVC  
PVC

**000956**  
Depo Kapağı/Tank Cap

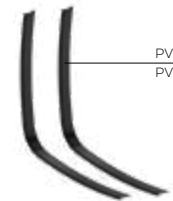

PVC  
PVC

**001951**  
Ayak Takoğu/Bracket Rubber

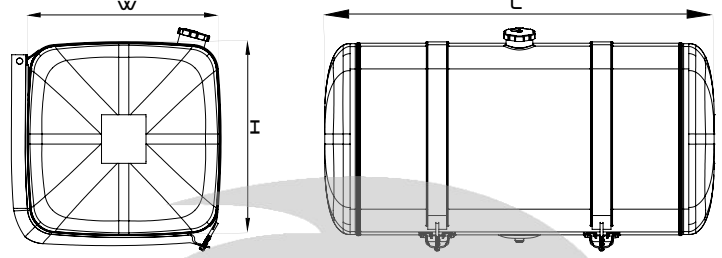

**Universal**

Seri No Serial No	Yükseklik (mm) Height (mm)	Genişlik (mm) Width (mm)	Uzunluk (mm) Length (mm)	Hacim (lt) Capacity (lt)
KT 7575 100	750	750	1000	540
KT 7575 125	750	750	1250	650
KT 7575 150	750	750	1500	780
KT 7575 154	750	750	1540	805
KT 7575 175	750	750	1750	890
KT 7575 200	750	750	2000	1050
KT 7575 224	750	750	2240	1180

**MONTAJ KITI / MOUNTING KIT**

 Çelik  
 Steel

**203803**  
 Ayak/Bracket

 Çelik  
 Steel

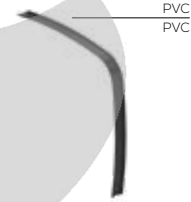
**203802**  
 Kuşak/Strap

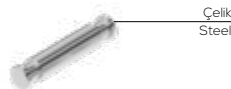
 PVC  
 PVC

**002169**  
 Kuşak Lastiği/Strap Rubber

 Çelik  
 Steel

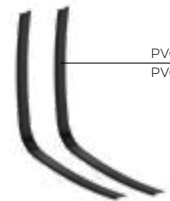
**204453**  
 Pim Takımı/Pin Sets

 PVC  
 PVC

**000956**  
 Depo Kapağı/Tank Cap

 PVC  
 PVC

**001951**  
 Ayak Takozu/Bracket Rubber



**KLÖTZE**  
TECHNIC

ALUMINIUM  
FUEL  
TANKS  
76X80

Universal

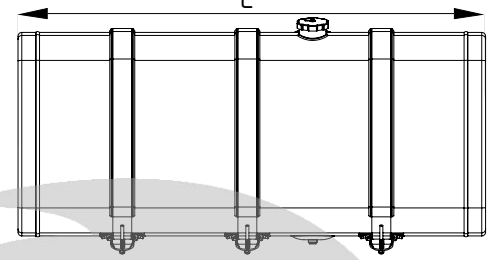
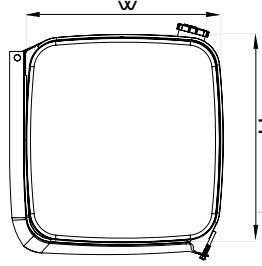

Seri No Serial No	Yükseklik (mm) Height (mm)	Genişlik (mm) Width (mm)	Uzunluk (mm) Length (mm)	Hacim (lt) Capacity (lt)
KT 7680 100	800	760	1000	585
KT 7680 185	800	760	1850	1085
KT 7680 200	800	760	2000	1175
KT 7680 210	800	760	2100	1235

MONTAJ KITI / MOUNTING KIT



Çelik  
Steel

**20441**  
Ayak/Bracket



Çelik  
Steel

**203945**  
Kuşak/Strap

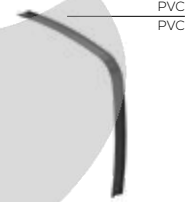

PVC  
PVC

**001998**  
Kuşak Lastiği/Strap Rubber



Çelik  
Steel

**204453**  
Pim Takımı/Pin Sets



PVC  
PVC

**000956**  
Depo Kapagı/Tank Cap

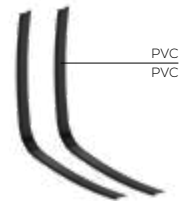

PVC  
PVC

**001951**  
Ayak Takozu/Bracket Rubber



**KLÖTZE**  
TECHNIC

ALUMINIUM  
THERMOKING  
TANKS

**56X64**

**Universal**

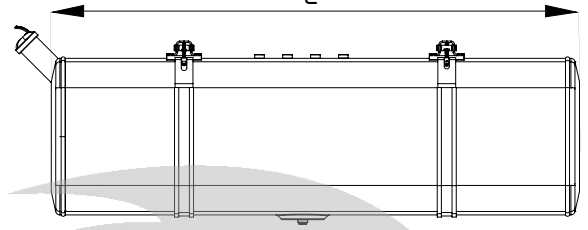
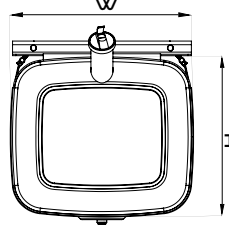

Seri No Serial No	Yükseklik (mm) Height (mm)	Genişlik (mm) Width (mm)	Uzunluk (mm) Length (mm)	Hacim (lt) Capacity (lt)
AT 5664 189	560	640	1890	620

**MONTAJ KITI / MOUNTING KIT**



Çelik  
Steel

**202748**  
Ayak/Bracket

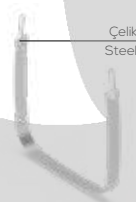

Çelik  
Steel

**202749**  
Kuşak/Strap



PVC  
PVC

**204461**  
Kuşak Lastiği/Strap Rubber

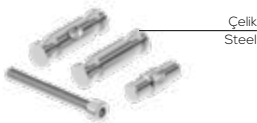

Çelik  
Steel

**204462**  
Pim Takımı/Pim Sets



PVC  
PVC

**000691**  
Depo Kapagı/Tank Cap

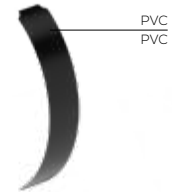

PVC  
PVC

**001555**  
Ayak Takozu/Bracket Rubber



**KLÖTZE**  
TECHNIC

# ALUMINIUM THERMOKING TANKS 62X67



## Universal

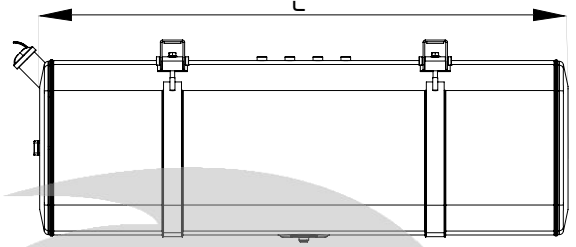
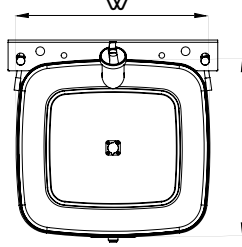

Seri No Serial No	Yükseklik (mm) Height (mm)	Genişlik (mm) Width (mm)	Uzunluk (mm) Length (mm)	Hacim (lt) Capacity (lt)
AT 6267 189	620	675	1890	735

## MONTAJ KITI / MOUNTING KIT



Çelik  
Steel

**204309**  
Ayak/Bracket



Çelik  
Steel

**204310**  
Kuşak/Strap



PVC  
PVC

**002175**  
Kuşak Lastiği/Strap Rubber

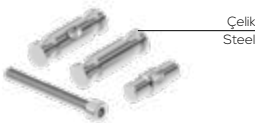

Çelik  
Steel

**204460**  
Pim Takımı/Pim Sets



PVC  
PVC

**000691**  
Depo Kapagı/Tank Cap



PVC  
PVC

**002176**  
Ayak Takozu/Bracket Rubber



**KLÖTZE**  
TECHNIC

ALUMINIUM  
THERMOKING  
TANKS Ø625

Universal

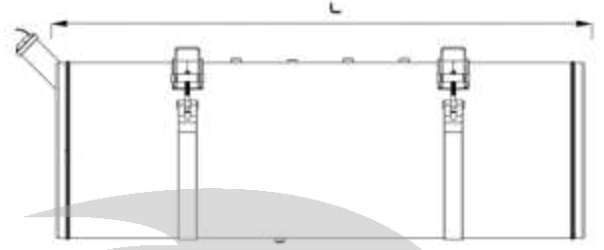
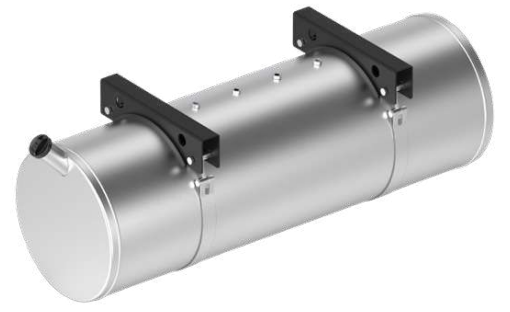

**Seri No**  
Serial No

**Yükseklik (mm)**  
Height (mm)

**Genişlik (mm)**  
Width (mm)

**Uzunluk (mm)**  
Length (mm)

**Hacim (lt)**  
Capacity (lt)

AT 625 189

Ø625

1890

570

MONTAJ KITI / MOUNTING KIT



**204134**  
Ayak/Bracket



**204133**  
Kuşak/Strap

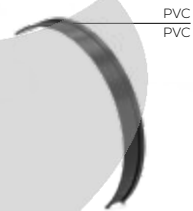

**002171**  
Kuşak Lastiği/Strap Rubber

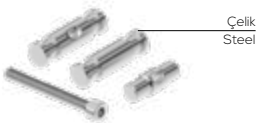

**204459**  
Pim Takımı/Pim Sets



**000691**  
Depo Kapagi/Tank Cap



**002172**  
Ayak Takozu/Bracket Rubber



**KLÖTZE**  
TECHNIC

ALUMINIUM  
COMBI  
TANKS  
**62X67**

**Universal**

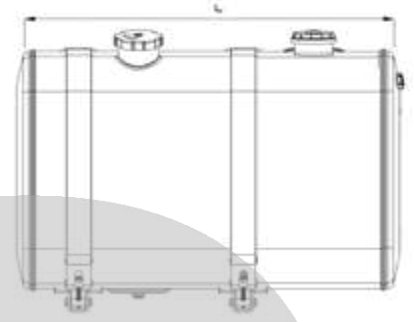
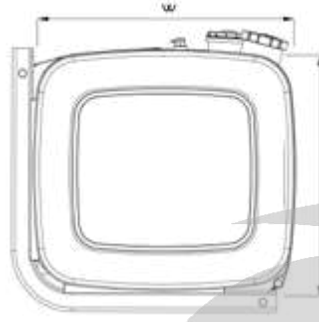

Seri No Serial No	Yükseklik (mm) Height (mm)	Genişlik (mm) Width (mm)	Uzunluk (mm) Length (mm)	Hacim (lt) Capacity (lt)
AC 6267 100	620	675	1000	FUEL-230 / OIL-170

**MONTAJ KITI / MOUNTING KIT**



Çelik  
Steel

**201306**  
Ayak/Bracket



Çelik  
Steel

**200642**  
Kuşak/Strap

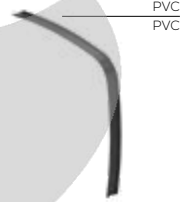

PVC  
PVC

**000297**  
Kuşak Lastiği/Strap Rubber

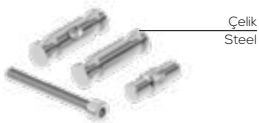

Çelik  
Steel

**204431**  
Pim Takımı/Pin Sets

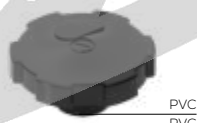

PVC  
PVC

**000956**  
Depo Kapagı/Tank Cap

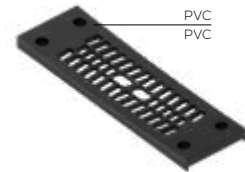

PVC  
PVC

**001555**  
Ayak Takozu/Bracket Rubber



**KLÖTZE**  
TECHNIC

ALUMINIUM  
ADBLUE  
TANKS  
**62X67**

**Man**

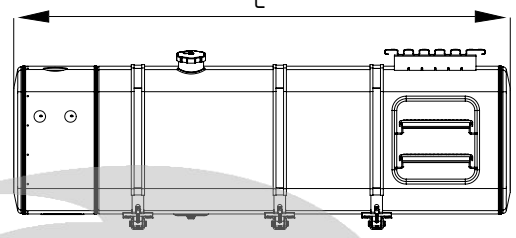
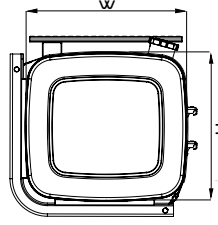

Seri No Serial No	Yükseklik (mm) Height (mm)	Genişlik (mm) Width (mm)	Uzunluk (mm) Length (mm)	Hacim (lt) Capacity (lt)
AD 6267 210	620	675	2100	820

**MONTAJ KITI / MOUNTING KIT**



Çelik  
Steel

**201306**  
Ayak/Bracket



Çelik  
Steel

**200642**  
Kuşak/Strap

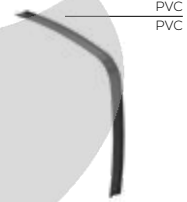

PVC  
PVC

**000297**  
Kuşak Lastiği/Strap Rubber

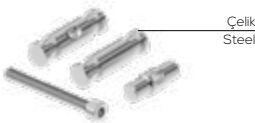

Çelik  
Steel

**204431**  
Pim Takımı/Pin Sets

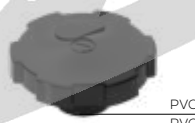

PVC  
PVC

**000956**  
Depo Kapagı/Tank Cap

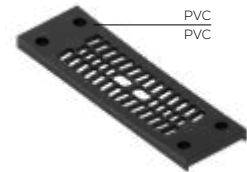

PVC  
PVC

**001555**  
Ayak Takozu/Bracket Rubber



**KLÖTZE**  
TECHNIC

ALUMINIUM  
ADBLUE  
TANKS  
**69X69**

**Man**

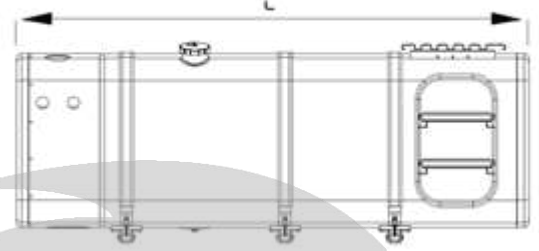
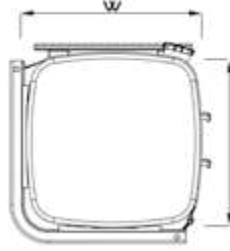

Seri No Serial No	Yükseklik (mm) Height (mm)	Genişlik (mm) Width (mm)	Uzunluk (mm) Length (mm)	Hacim (lt) Capacity (lt)
AD 6969 210	690	690	2100	970

**MONTAJ KITI / MOUNTING KIT**



**201305**  
Ayak/Bracket



**200004**  
Kuşak/Strap

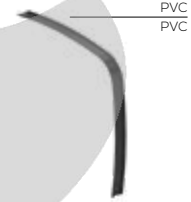

**200005**  
Kuşak Lastiği/Strap Rubber

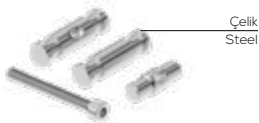

**201307**  
Pim Takımı/Pim Sets

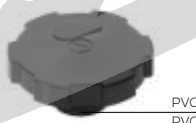

**000956**  
Depo Kapağı/Tank Cap

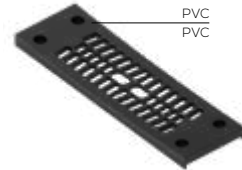

**001555**  
Ayak Takozu/Bracket Rubber





**KLÖTZE**  
TECHNIC

ALUMINIUM  
OIL  
TANKS  
**20X70**  
REAR MOUNTED

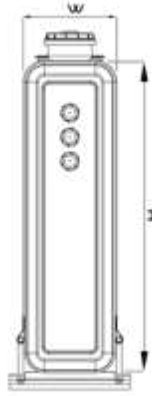

Seri No Serial No	Yükseklik (mm) Height (mm)	Genişlik (mm) Width (mm)	Uzunluk (mm) Length (mm)	Hacim (lt) Capacity (lt)
AR 2070 062	700	200	620	85
AR 2070 103	700	200	1030	140

MONTAJ KITI / MOUNTING KIT



Çelik  
Steel



Çelik  
Steel



Krom  
Chromium



PVC  
PVC

**204456**  
Ayak/Bracket

**204458**  
Kuşak/Strap

**204457**  
Kuşak/Strap

**001640**  
Kuşak Lastiği/Strap Rubber



PVC  
PVC



PVC  
PVC

**200446**  
Depo Kapagı/Tank Cap

**001641**  
Ayak Takozu/Bracket Rubber



**KLÖTZE**  
TECHNIC

ALUMINIUM  
OIL  
TANKS  
**25X70**  
REAR MOUNTED

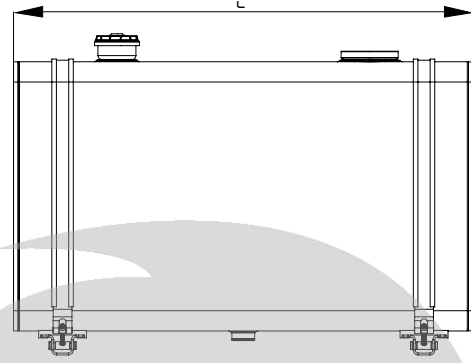
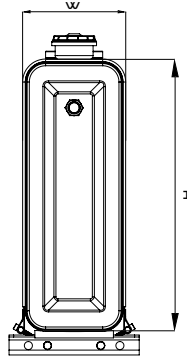

Seri No Serial No	Yükseklik (mm) Height (mm)	Genişlik (mm) Width (mm)	Uzunluk (mm) Length (mm)	Hacim (lt) Capacity (lt)
AR 2570 062	700	250	620	85
AR 2570 103	700	250	1030	140

MONTAJ KITI / MOUNTING KIT



**200494**  
Ayak/Bracket



**200223**  
Kuşak/Strap

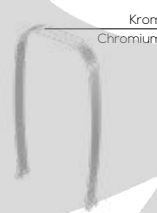

**201902**  
Kuşak/Strap

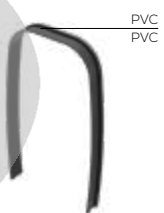

**001688**  
Kuşak Lastiği/Strap Rubber

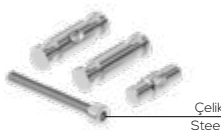

**201557**  
Pim Takımı/Pim Sets



**200446**  
Depo Kapağı/Tank Cap

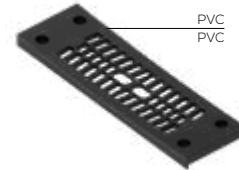

**001557**  
Ayak Takoğu/Bracket Rubber



**KLÖTZE**  
TECHNIC

ALUMINIUM  
OIL  
TANKS  
**28X70**  
REAR MOUNTED

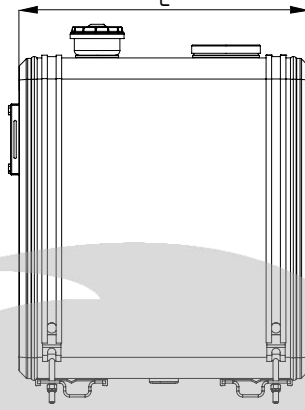
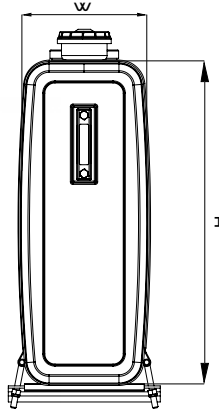

Seri No Serial No	Yükseklik (mm) Height (mm)	Genişlik (mm) Width (mm)	Uzunluk (mm) Length (mm)	Hacim (lt) Capacity (lt)
AR 2870 055	700	280	550	100
AR 2870 062	700	280	620	110
AR 2870 125	700	280	1250	225
AR 2870 133	700	280	1330	235

**MONTAJ KITI / MOUNTING KIT**



**204285**  
Ayak/Bracket



**203722**  
Kuşak/Strap



**204283**  
Kuşak/Strap

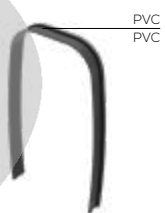

**001194**  
Kuşak Lastiği/Strap Rubber



**200446**  
Depo Kapağı/Tank Cap

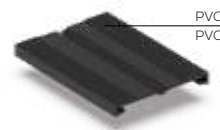

**001185**  
Ayak Takoğu/Bracket Rubber



**KLÖTZE**  
TECHNIC

ALUMINIUM  
OIL  
TANKS

**31X41**

REAR MOUNTED

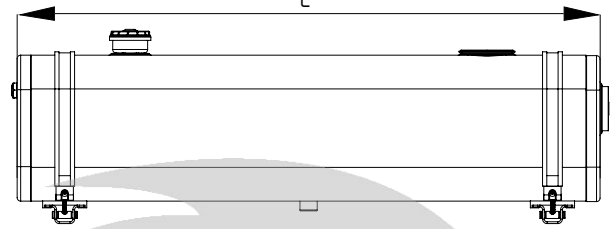
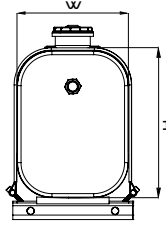

Seri No Serial No	Yükseklik (mm) Height (mm)	Genişlik (mm) Width (mm)	Uzunluk (mm) Length (mm)	Hacim (lt) Capacity (lt)
AR 3141 060	410	310	600	65
AR 3141 075	410	310	750	75
AR 3141 115	410	310	1150	125
AR 3141 140	410	310	1400	150

MONTAJ KITI / MOUNTING KIT



**200494**  
Ayak/Bracket



**200198**  
Kuşak/Strap

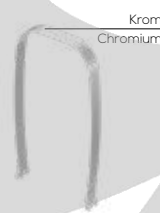

**201613**  
Kuşak/Strap

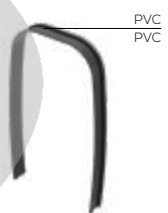

**001689**  
Kuşak Lastiği/Strap Rubber

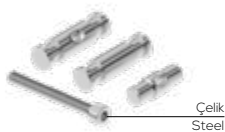

**201557**  
Pim Takımı/Pim Sets



**200446**  
Depo Kapağı/Tank Cap

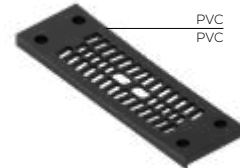

**001557**  
Ayak Takozu/Bracket Rubber

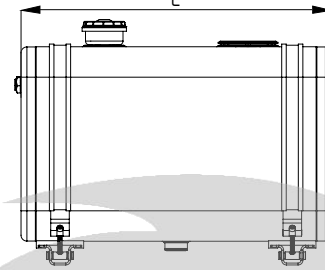
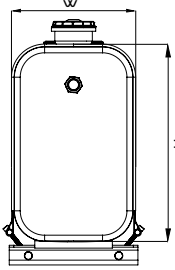

Seri No Serial No	Yükseklik (mm) Height (mm)	Genişlik (mm) Width (mm)	Uzunluk (mm) Length (mm)	Hacim (lt) Capacity (lt)
AR 3151 068	510	310	680	90
AR 3151 077	510	310	770	100
AR 3151 085	510	310	850	110
AR 3151 100	510	310	1000	135
AR 3151 110	510	310	1100	150
AR 3151 125	510	310	1250	180

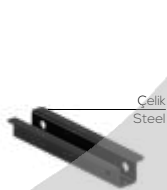
**MONTAJ KITI / MOUNTING KIT**

**200494**  
 Ayak/Bracket

**200898**  
 Kuşak/Strap

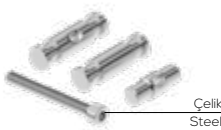
**201163**  
 Kuşak/Strap

**000711**  
 Kuşak Lastiği/Strap Rubber

**201557**  
 Pim Takımı/Pim Sets

**200446**  
 Depo Kapağı/Tank Cap

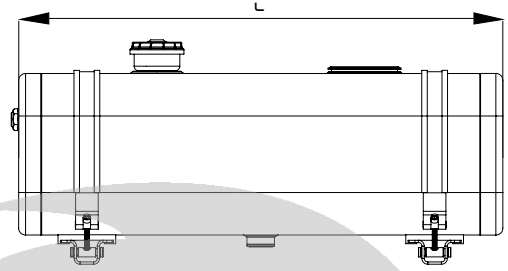
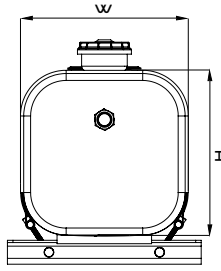
**001557**  
 Ayak Takozu/Bracket Rubber

ALUMINIUM  
 OIL  
 TANKS  
**35X35**  
 REAR MOUNTED

Seri No Serial No	Yükseklik (mm) Height (mm)	Genişlik (mm) Width (mm)	Uzunluk (mm) Length (mm)	Hacim (lt) Capacity (lt)
AR 3535 65	350	350	650	75
AR 3535 100	350	350	1000	115
AR 3535 130	350	350	1300	150
AR 3535 160	350	350	1600	190

## MONTAJ KITI / MOUNTING KIT

**200117**  
 Ayak/Bracket

**200119**  
 Kuşak/Strap

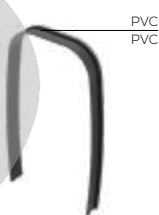
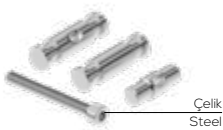
**200172**  
 Kuşak/Strap

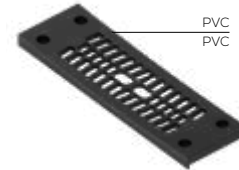
**001693**  
 Kuşak Lastiği/Strap Rubber

**201557**  
 Pim Takımı/Pim Sets

**200446**  
 Depo Kapağı/Tank Cap

**001557**  
 Ayak Takoğu/Bracket Rubber

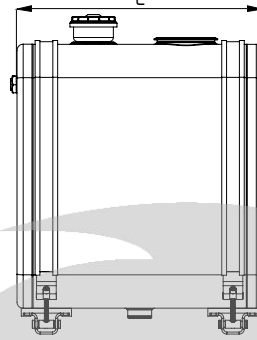
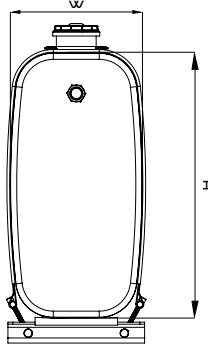

**KLÖTZE**  
TECHNIC

ALUMINIUM  
OIL  
TANKS  
**32X65**  
REAR MOUNTED



Seri No Serial No	Yükseklik (mm) Height (mm)	Genişlik (mm) Width (mm)	Uzunluk (mm) Length (mm)	Hacim (lt) Capacity (lt)
AR 3265 065	650	320	650	125
AR 3265 090	650	320	900	170
AR 3265 110	650	320	1100	205
AR 3265 125	650	320	1250	235

MONTAJ KITI / MOUNTING KIT



**200494**  
Ayak/Bracket



**200530**  
Kuşak/Strap

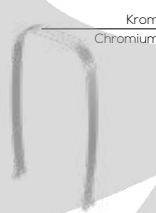

**200968**  
Kuşak/Strap



**200391**  
Kuşak Lastiği/Strap Rubber

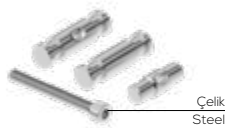

**201557**  
Pim Takımı/Pim Sets



**200446**  
Depo Kapağı/Tank Cap

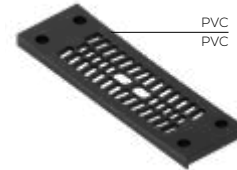

**001557**  
Ayak Takozu/Bracket Rubber

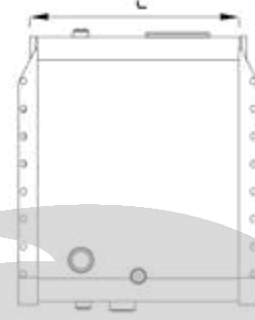
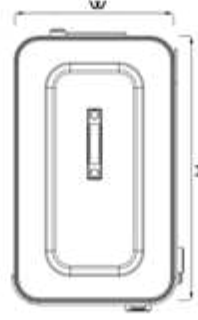

Seri No Serial No	Yükseklik (mm) Height (mm)	Genişlik (mm) Width (mm)	Uzunluk (mm) Length (mm)	Hacim (lt) Capacity (lt)
KTA 3558 047	580	350	470	85
KTA 3558 050	580	350	500	90
KTA 3558 055	580	350	550	100



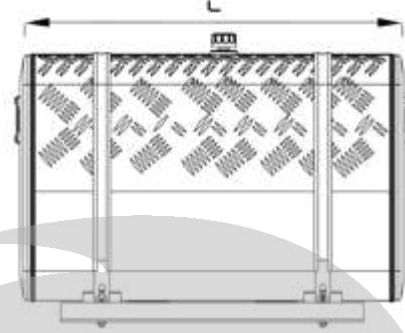
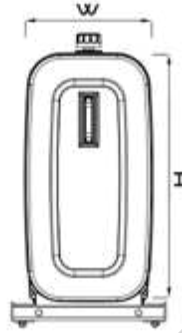

Seri No Serial No	Yükseklik (mm) Height (mm)	Genişlik (mm) Width (mm)	Uzunluk (mm) Length (mm)	Hacim (lt) Capacity (lt)
AR 4181 090	810	410	900	275
AR 4181 110	810	410	1100	335
AR 4181 125	810	410	1250	385

**MONTAJ KITI / MOUNTING KIT**

 Çelik  
Steel

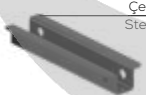
**202677**  
Ayak/Bracket

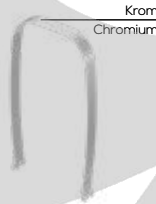
 Çelik  
Steel

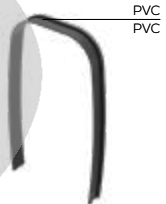
**202676**  
Kuşak/Strap

 Krom  
Chromium

**202289**  
Kuşak/Strap

 PVC  
PVC

**001661**  
Kuşak Lastiği/Strap Rubber

 Çelik  
Steel

**201557**  
Pim Takımı/Pim Sets

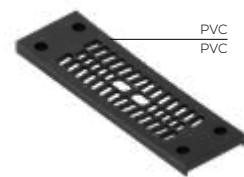
 PVC  
PVC

**000274**  
Depo Kapağı/Tank Cap

 PVC  
PVC

**001707**  
Ayak Takozu/Bracket Rubber

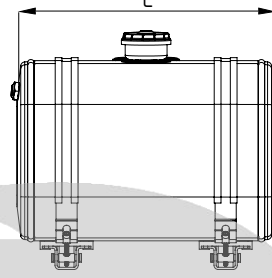
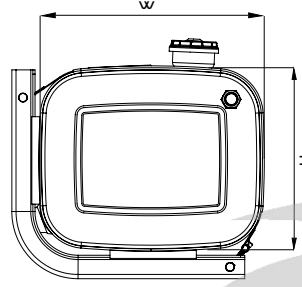

**KLÖTZE**  
TECHNIC

ALUMINIUM  
OIL TANKS  
**42X52**  
SIDE MOUNTED



Seri No Serial No	Yükseklik (mm) Height (mm)	Genişlik (mm) Width (mm)	Uzunluk (mm) Length (mm)	Hacim (lt) Capacity (lt)
KTA 4252 040	420	520	400	75
KTA 4252 050	420	520	500	90
KTA 4252 060	420	520	600	110

MONTAJ KITI / MOUNTING KIT



Çelik  
Steel

**201009**  
Ayak/Bracket



Çelik  
Steel

**202468**  
Kuşak/Strap



Krom  
Chromium

**202469**  
Kuşak/Strap

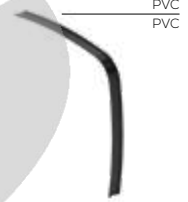

PVC  
PVC

**001620**  
Kuşak Lastiği/Strap Rubber



Çelik  
Steel

**201302**  
Pim Takımı/Pim Sets



PVC  
PVC

**200446**  
Depo Kapağı/Tank Cap



PVC  
PVC

**001557**  
Ayak Takozu/Bracket Rubber



**KLÖTZE**  
TECHNIC

ALUMINIUM  
OIL  
TANKS  
**42X52**  
REAR MOUNTED

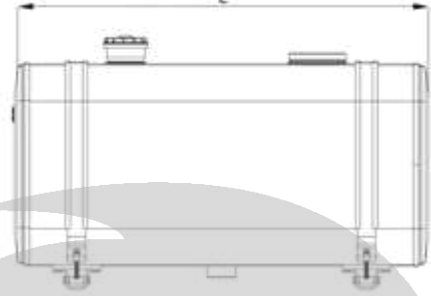

Seri No Serial No	Yükseklik (mm) Height (mm)	Genişlik (mm) Width (mm)	Uzunluk (mm) Length (mm)	Hacim (lt) Capacity (lt)
AR 4252 079	520	420	790	140
AR 4252 089	520	420	890	160
AR 4252 098	520	420	980	180
AR 4252 110	520	420	1100	200
AR 4252 125	520	420	1250	230

MONTAJ KITI / MOUNTING KIT



**200867**  
Ayak/Bracket



**202470**  
Kuşak/Strap

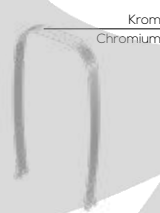

**202471**  
Kuşak/Strap

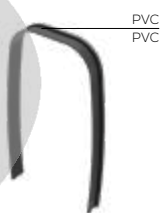

**001784**  
Kuşak Lastiği/Strap Rubber

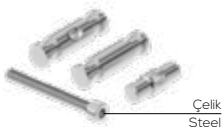

**201557**  
Pim Takımı/Pim Sets



**200446**  
Depo Kapağı/Tank Cap



**001557**  
Ayak Takozu/Bracket Rubber



**KLÖTZE**  
TECHNIC

ALUMINIUM  
OIL TANKS  
**50X56**  
SIDE MOUNTED

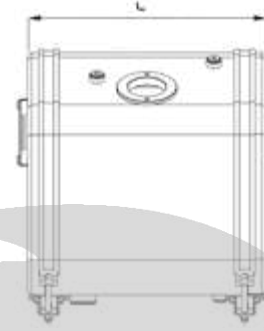
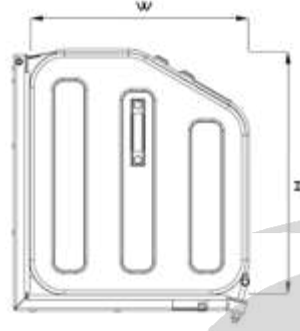

Seri No Serial No	Yükseklik (mm) Height (mm)	Genişlik (mm) Width (mm)	Uzunluk (mm) Length (mm)	Hacim (lt) Capacity (lt)
KTA 5056 050	560	500	500	125
KTA 5056 060	560	500	600	150
KTA 5056 065	560	500	650	160

MONTAJ KITI / MOUNTING KIT



**203228-203229**  
Ayak/Bracket



**001753**  
Kuşak/Strap



**001648**  
Kuşak Lastiği/Strap Rubber

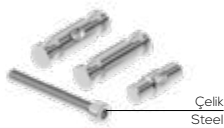

**204463**  
Pim Takımı/Pim Sets



**001650-001651**  
Ayak Takozu/Bracket Rubber



**KLÖTZE**  
TECHNIC

ALUMINIUM  
OIL TANKS  
**56X64**  
SIDE MOUNTED

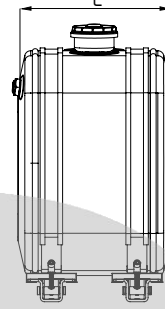
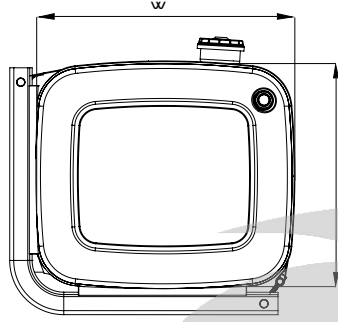

Seri No Serial No	Yükseklik (mm) Height (mm)	Genişlik (mm) Width (mm)	Uzunluk (mm) Length (mm)	Hacim (lt) Capacity (lt)
KTA 5664 040	560	640	400	120
KTA 5664 050	560	640	500	160
KTA 5664 060	560	640	600	190

**MONTAJ KITI / MOUNTING KIT**



Çelik  
Steel

**201126**  
Ayak/Bracket

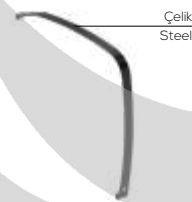

Çelik  
Steel

**200225**  
Kuşak/Strap



Krom  
Chromium

**201174**  
Kuşak/Strap

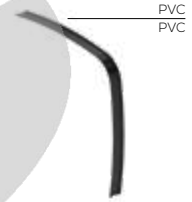

PVC  
PVC

**001643**  
Kuşak Lastiği/Strap Rubber

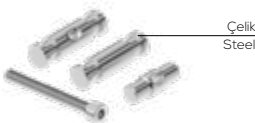

Çelik  
Steel

**201302**  
Pim Takımı/Pin Sets



PVC  
PVC

**200446**  
Depo Kapağı/Tank Cap

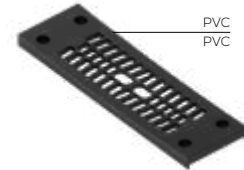

PVC  
PVC

**001555**  
Ayak Takozu/Bracket Rubber

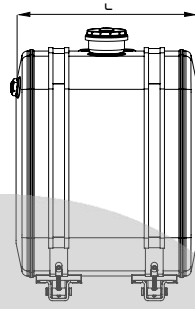
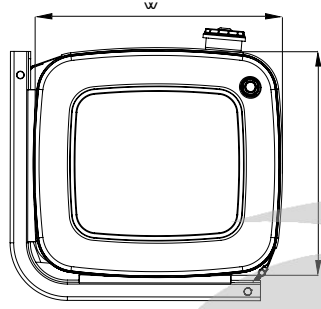

Seri No Serial No	Yükseklik (mm) Height (mm)	Genişlik (mm) Width (mm)	Uzunluk (mm) Length (mm)	Hacim (lt) Capacity (lt)
KTA 6267 040	620	675	400	150
KTA 6267 050	620	675	500	180
KTA 6267 060	620	675	600	220

**MONTAJ KITI / MOUNTING KIT**

**201014**  
 Ayak/Bracket

**200224**  
 Kuşak/Strap

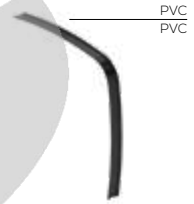
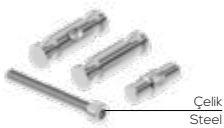
**200173**  
 Kuşak/Strap

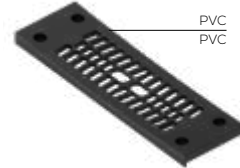
**000711**  
 Kuşak Lastiği/Strap Rubber

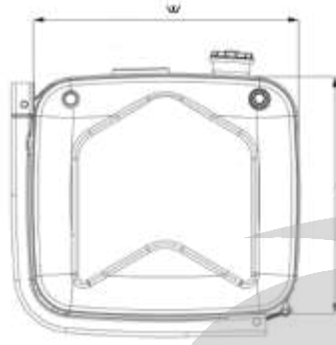
**201302**  
 Pim Takımı/Pim Sets

**200446**  
 Depo Kapağı/Tank Cap

**001555**  
 Ayak Takozu/Bracket Rubber



Seri No Serial No	Yükseklik (mm) Height (mm)	Genişlik (mm) Width (mm)	Uzunluk (mm) Length (mm)	Hacim (lt) Capacity (lt)
KTA 6370 040	630	700	400	165
KTA 6370 042	630	700	420	175
KTA 6370 050	630	700	500	210
KTA 6370 060	630	700	600	250

**MONTAJ KITI / MOUNTING KIT**

 Çelik  
Steel

**204175**  
Ayak/Bracket

 Çelik  
Steel

**204454**  
Kuşak/Strap

 Krom  
Chromium

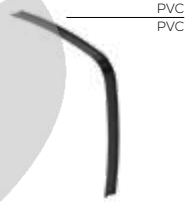
**204176**  
Kuşak/Strap

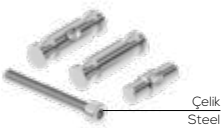
 PVC  
PVC

**002127**  
Kuşak Lastiği/Strap Rubber

 Çelik  
Steel

**204455**  
Pim Takımı/Pim Sets

 PVC  
PVC

**200446**  
Depo Kapağı/Tank Cap

 PVC  
PVC

**000455**  
Ayak Takozu/Bracket Rubber

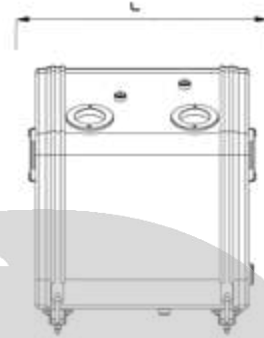

Seri No Serial No	Yükseklik (mm) Height (mm)	Genişlik (mm) Width (mm)	Uzunluk (mm) Length (mm)	Hacim (lt) Capacity (lt)
KTA 6370 050	700	630	500	195
KTA 6370 060	700	630	600	230
KTA 6370 065	700	630	650	250

## MONTAJ KITI / MOUNTING KIT

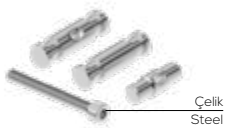
Çelik  
SteelKrom  
ChromiumPVC  
PVC**203230**  
Ayak/Bracket**001754**  
Kuşak/Strap**001649**  
Kuşak Lastiği/Strap RubberÇelik  
SteelPVC  
PVC**204463**  
Pim Takımı/Pim Sets**001652-001653**  
Ayak Takozu/Bracket Rubber



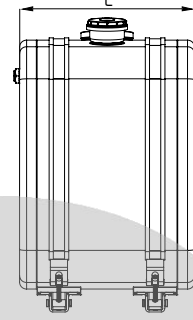
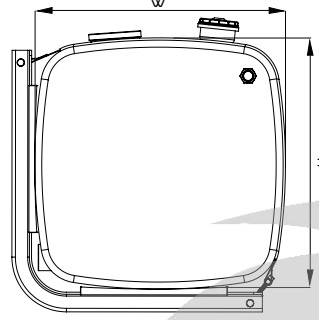

Seri No Serial No	Yükseklik (mm) Height (mm)	Genişlik (mm) Width (mm)	Uzunluk (mm) Length (mm)	Hacim (lt) Capacity (lt)
KTA 6969 040	690	690	400	160
KTA 6969 050	690	690	500	200
KTA 6969 060	690	690	600	240

## MONTAJ KITI / MOUNTING KIT

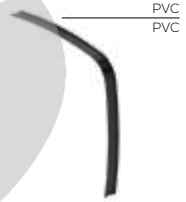
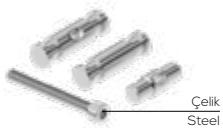
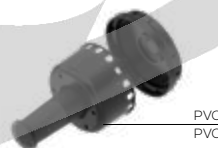
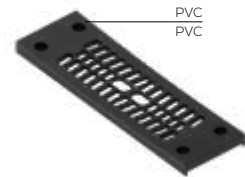
**201127**  
Ayak/Bracket**200816**  
Kuşak/Strap**202168**  
Kuşak/Strap**201922**  
Kuşak Lastiği/Strap Rubber**201302**  
Pim Takımı/Pim Sets**200446**  
Depo Kapağı/Tank Cap**001555**  
Ayak Takozu/Bracket Rubber

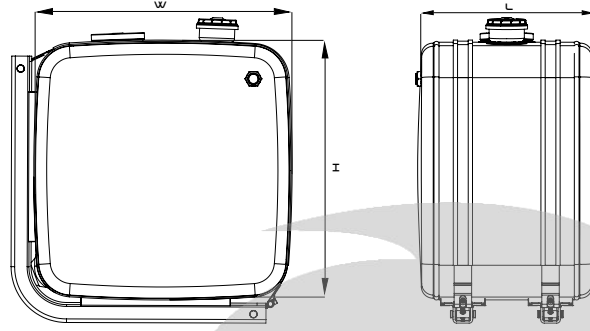

Seri No Serial No	Yükseklik (mm) Height (mm)	Genişlik (mm) Width (mm)	Uzunluk (mm) Length (mm)	Hacim (lt) Capacity (lt)
KTA 7171 040	710	710	400	195
KTA 7171 050	710	710	500	245
KTA 7171 060	710	710	600	295

## MONTAJ KITI / MOUNTING KIT

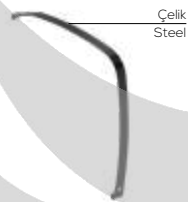
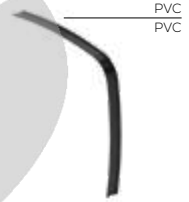
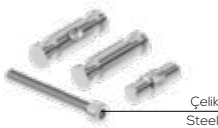
Çelik  
Steel**201127**  
Ayak/BracketÇelik  
Steel**200318**  
Kuşak/StrapKrom  
Chromium**202084**  
Kuşak/StrapPVC  
PVC**200319**  
Kuşak Lastiği/Strap RubberÇelik  
Steel**201302**  
Pim Takımı/Pim SetsPVC  
PVC**200446**  
Depo Kapağı/Tank CapPVC  
PVC**001555**  
Ayak Takozu/Bracket Rubber



**KLÖTZE**  
TECHNIC

ALUMINIUM  
OIL TANKS

Ø400

SIDE MOUNTED

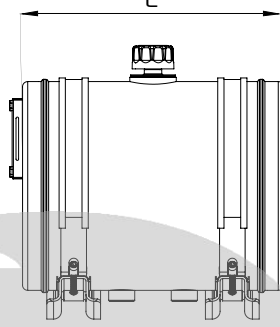
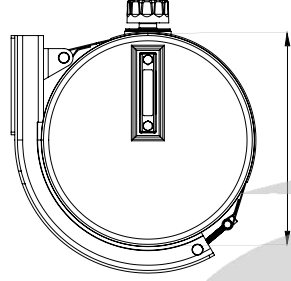

Seri No Serial No	Yükseklik (mm) Height (mm)	Genişlik (mm) Width (mm)	Uzunluk (mm) Length (mm)	Hacim (lt) Capacity (lt)
KTA 400 035		Ø400	350	40
KTA 400 050		Ø400	500	60
KTA 400 065		Ø400	650	80
KTA 400 080		Ø400	800	100
KTA 400 100		Ø400	1000	120

MONTAJ KITI / MOUNTING KIT



Çelik  
Steel

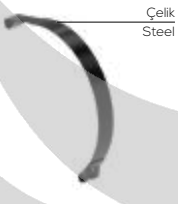

Çelik  
Steel

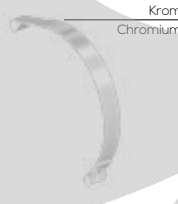

Krom  
Chromium

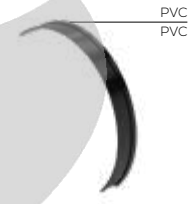

PVC  
PVC

**203422**  
Ayak/Bracket

**204433**  
Kuşak/Strap

**203423**  
Kuşak/Strap

**204434**  
Kuşak Lastiği/Strap Rubber



Çelik  
Steel



PVC  
PVC



PVC  
PVC

**201302**  
Pim Takımı/Pim Sets

**000274**  
Depo Kapağı/Tank Cap

**204435**  
Ayak Lastiği/Bracket Rubber

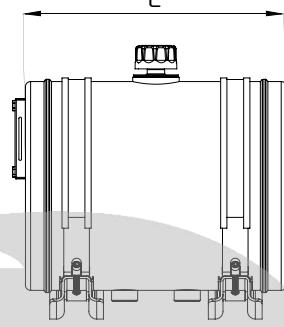
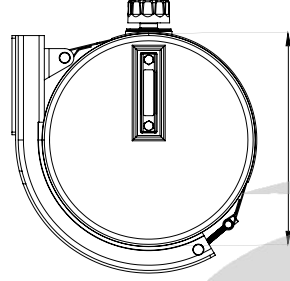

Seri No Serial No	Yükseklik (mm) Height (mm)	Genişlik (mm) Width (mm)	Uzunluk (mm) Length (mm)	Hacim (lt) Capacity (lt)
KTA 550 027		Ø550	270	60
KTA 550 035		Ø550	350	80
KTA 550 052		Ø550	520	120
KTA 550 065		Ø550	650	150
KTA 550 085		Ø550	850	200

## MONTAJ KITI / MOUNTING KIT

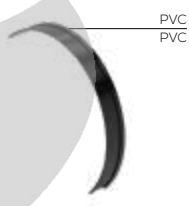
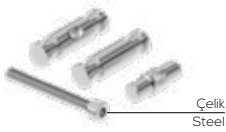

**203427**  
 Ayak/Bracket

**202468**  
 Kuşak/Strap

**202682**  
 Kuşak/Strap

**001690**  
 Kuşak Lastiği/Strap Rubber

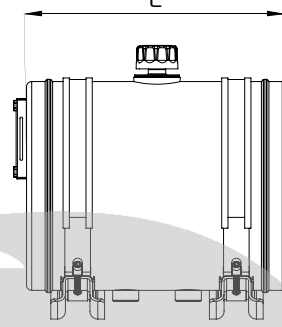
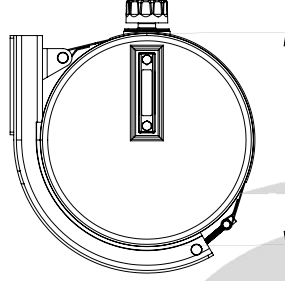
**201302**  
 Pim Takımı/Pim Sets

**000274**  
 Depo Kapağı/Tank Cap

**204436**  
 Ayak Lastiği/Bracket Rubber



Seri No Serial No	Yükseklik (mm) Height (mm)	Genişlik (mm) Width (mm)	Uzunluk (mm) Length (mm)	Hacim (lt) Capacity (lt)
KTA 625 045		Ø625	450	130
KTA 625 055		Ø625	550	160
KTA 625 070		Ø625	700	200
KTA 625 077		Ø625	770	230
KTA 625 085		Ø625	850	250

**MONTAJ KITI / MOUNTING KIT**

 Çelik  
 Steel

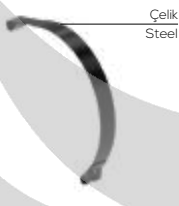
**202967**  
 Ayak/Bracket

 Çelik  
 Steel

**200225**  
 Kuşak/Strap

 Krom  
 Chromium

**202990**  
 Kuşak/Strap

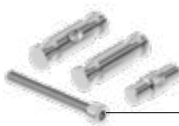
 PVC  
 PVC

**001643**  
 Kuşak Lastiği/Strap Rubber

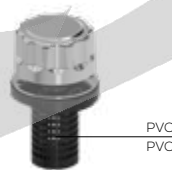
 Çelik  
 Steel

**201302**  
 Pim Takımı/Pim Sets

 PVC  
 PVC

**000274**  
 Depo Kapağı/Tank Cap

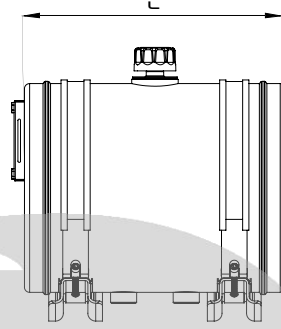
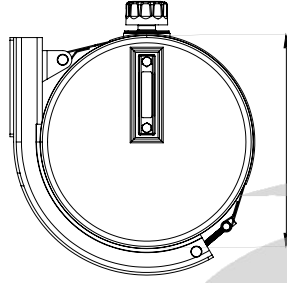
 PVC  
 PVC

**204436**  
 Ayak Lastiği/Bracket Rubber



Seri No Serial No	Yükseklik (mm) Height (mm)	Genişlik (mm) Width (mm)	Uzunluk (mm) Length (mm)	Hacim (lt) Capacity (lt)
KTA 660 045		Ø660	450	150
KTA 660 055		Ø660	550	180
KTA 660 065		Ø660	650	220
KTA 660 075		Ø660	750	250
KTA 660 090		Ø660	900	300

**MONTAJ KITI / MOUNTING KIT**

 Çelik  
Steel

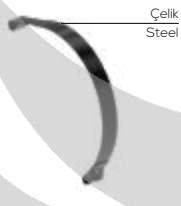
**203424**  
Ayak/Bracket

 Çelik  
Steel

**204438**  
Kuşak/Strap

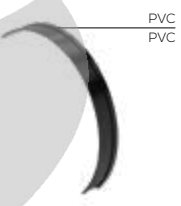
 Krom  
Chromium

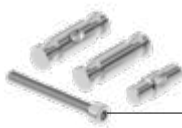
**203425**  
Kuşak/Strap

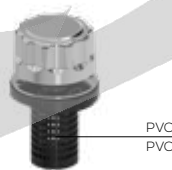
 PVC  
PVC

**204439**  
Kuşak Lastiği/Strap Rubber

 Çelik  
Steel

**201302**  
Pim Takımı/Pim Sets

 PVC  
PVC

**000274**  
Depo Kapağı/Tank Cap

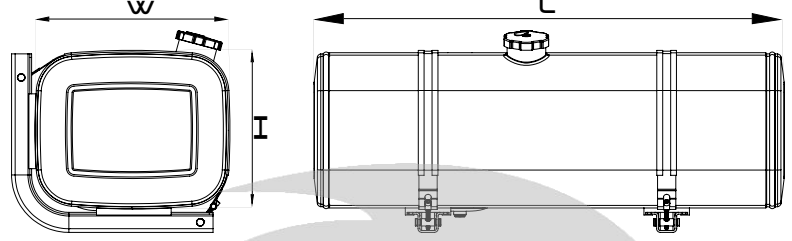
 PVC  
PVC

**204440**  
Ayak Lastiği/Bracket Rubber



Seri No Serial No	Yükseklik (mm) Height (mm)	Genişlik (mm) Width (mm)	Uzunluk (mm) Length (mm)	Hacim (lt) Capacity (lt)
KTS 4252 050	420	520	500	90
KTS 4252 085	420	520	850	160
KTS 4252 110	420	520	1100	210
KTS 4252 135	420	520	1350	260

**MONTAJ KITI / MOUNTING KIT**

 Çelik  
 Steel

**201009**  
 Ayak/Bracket

 Çelik  
 Steel

**202468**  
 Kuşak/Strap

 PVC  
 PVC

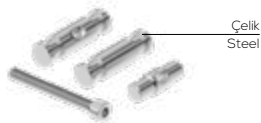
**001690**  
 Kuşak Lastiği/Strap Rubber

 Çelik  
 Steel

**201302**  
 Pim Takımı/Pin Sets

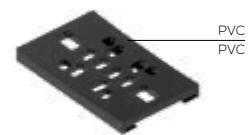
 PVC  
 PVC

**000956**  
 Depo Kapağı/Tank Cap

 PVC  
 PVC

**001557**  
 Ayak Takoğu/Bracket Rubber

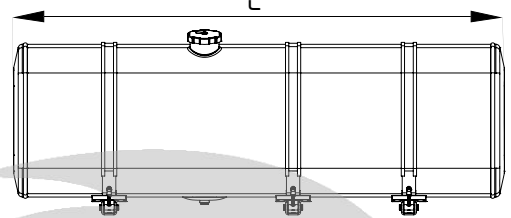
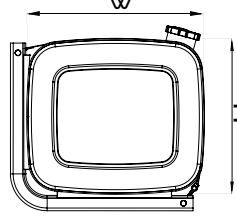

**KLÖTZE**  
TECHNIC

STEEL  
FUEL  
TANKS  
56X64



Seri No Serial No	Yükseklik (mm) Height (mm)	Genişlik (mm) Width (mm)	Uzunluk (mm) Length (mm)	Hacim (lt) Capacity (lt)
KTS 5654 073	560	640	730	230
KTS 5654 094	560	640	940	300
KTS 5654 125	560	640	1250	400

MONTAJ KITI / MOUNTING KIT



Çelik  
Steel

**201304**  
Ayak/Bracket



Çelik  
Steel

**200073**  
Kuşak/Strap

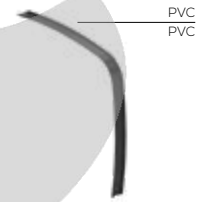

PVC  
PVC

**200074**  
Kuşak Lastiği/Strap Rubber

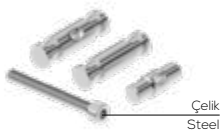

Çelik  
Steel

**201767**  
Pim Takımı/Pim Sets



PVC  
PVC

**00956**  
Depo Kapağı/Tank Cap

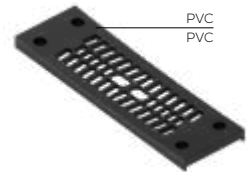

PVC  
PVC

**001555**  
Ayak Takozu/Bracket Rubber





**KLÖTZE**  
TECHNIC

STEEL  
FUEL  
TANKS  
**56X67**

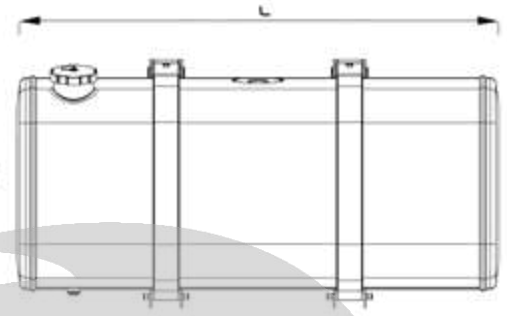
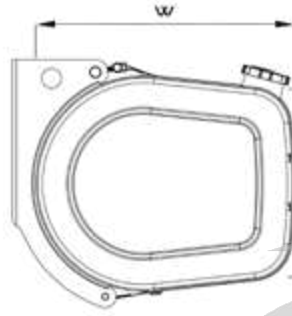

Seri No Serial No	Yükseklik (mm) Height (mm)	Genişlik (mm) Width (mm)	Uzunluk (mm) Length (mm)	Hacim (lt) Capacity (lt)
KTS 5667 103	560	670	1030	315
KTS 5667 123	560	670	1230	380
KTS 5667 133	560	670	1330	415
KTS 5667 143	560	670	1430	445

**MONTAJ KITI / MOUNTING KIT**



Çelik  
Steel

**202481**  
Ayak/Bracket



Çelik  
Steel

**202480**  
Kuşak/Strap



PVC  
PVC

**002173**  
Kuşak Lastiği/Strap Rubber

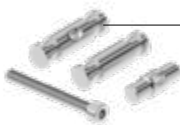

Çelik  
Steel

**201766**  
Pim Takımı/Pim Sets

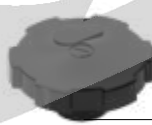

PVC  
PVC

**000956**  
Depo Kapağı/Tank Cap



PVC  
PVC

**002174**  
Ayak Takozu/Bracket Rubber



**KLÖTZE**  
TECHNIC

STEEL  
FUEL  
TANKS  
62X67

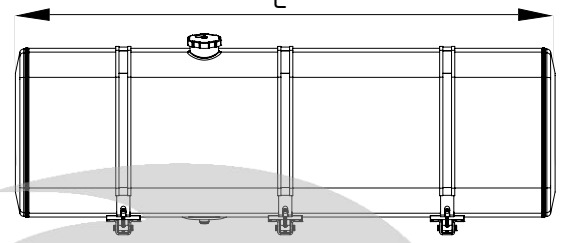
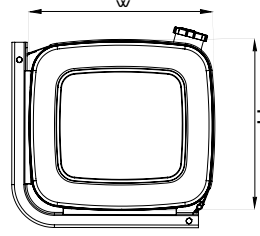

Seri No Serial No	Yükseklik (mm) Height (mm)	Genişlik (mm) Width (mm)	Uzunluk (mm) Length (mm)	Hacim (lt) Capacity (lt)
KTS 6267 070	620	675	700	250
KTS 6267 082	620	675	820	300
KTS 6267 107	620	675	1070	400
KTS 6267 135	620	675	1350	500

MONTAJ KITI / MOUNTING KIT



Çelik  
Steel

**201306**  
Ayak/Bracket



Çelik  
Steel

**200024**  
Kuşak/Strap

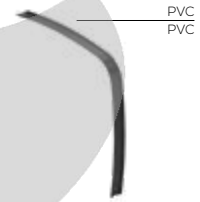

PVC  
PVC

**200023**  
Kuşak Lastiği/Strap Rubber

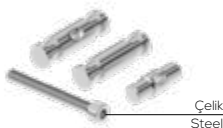

Çelik  
Steel

**201767**  
Pim Takımı/Pim Sets



PVC  
PVC

**000956**  
Depo Kapağı/Tank Cap

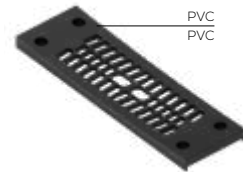

PVC  
PVC

**001555**  
Ayak Takozu/Bracket Rubber



**KLÖTZE**  
TECHNIC

STEEL  
FUEL  
TANKS  
65X70

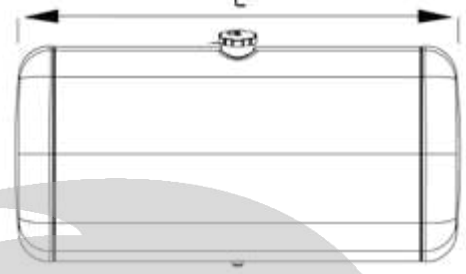
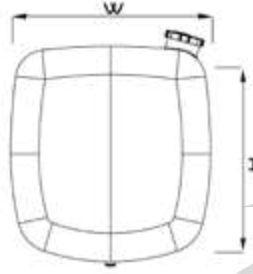

Seri No Serial No	Yükseklik (mm) Height (mm)	Genişlik (mm) Width (mm)	Uzunluk (mm) Length (mm)	Hacim (lt) Capacity (lt)
KTS 6570 085	700	650	850	315
KTS 6570 110	700	650	1100	380
KTS 6570 130	700	650	1300	415
KTS 6570 145	700	650	1450	445



**KLÖTZE**  
TECHNIC

STEEL  
FUEL  
TANKS  
67X70

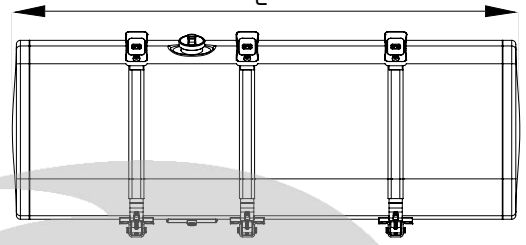
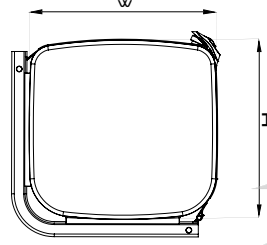

Seri No Serial No	Yükseklik (mm) Height (mm)	Genişlik (mm) Width (mm)	Uzunluk (mm) Length (mm)	Hacim (lt) Capacity (lt)
KTS 6770 039	670	700	390	150
KTS 6770 041	670	700	415	175
KTS 6770 073	670	700	730	300
KTS 6770 086	670	700	860	350
KTS 6770 100	670	700	1000	400
KTS 6770 119	670	700	1190	470
KTS 6770 126	670	700	1260	500

MONTAJ KITI / MOUNTING KIT



Çelik  
Steel

**201306**  
Ayak/Bracket

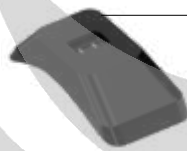

PVC  
PVC

**001007**  
Kuşak Kapağı/Strap Cap

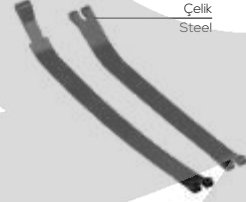

Çelik  
Steel

**201221 - 201222**  
Kuşak/Strap

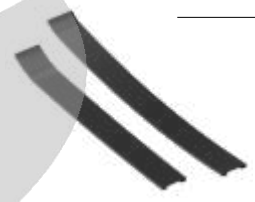

PVC  
PVC

**201219 - 201220**  
Kuşak Lastiği/Strap Rubber

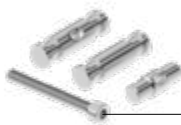

Çelik  
Steel

**201905**  
Pim Takımı/Pim Sets



PVC  
PVC

**000691**  
Depo Kapağı/Tank Cap

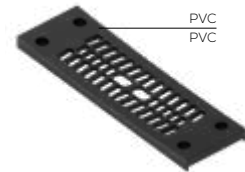

PVC  
PVC

**001555**  
Ayak Takoğu/Bracket Rubber



**KLÖTZE**  
TECHNIC

STEEL  
FUEL  
TANKS  
69X69

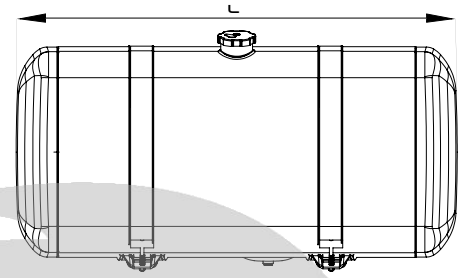
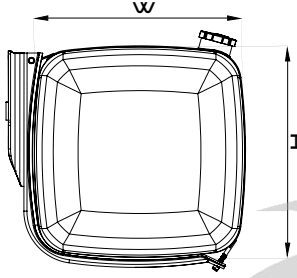

Seri No Serial No	Yükseklik (mm) Height (mm)	Genişlik (mm) Width (mm)	Uzunluk (mm) Length (mm)	Hacim (lt) Capacity (lt)
KTS 6969 065	690	690	650	280
KTS 6969 076	690	690	760	300
KTS 6969 090	690	690	900	400
KTS 6969 107	690	690	1070	450
KTS 6969 123	690	690	1230	550
KTS 6969 150	690	690	1500	650

MONTAJ KITI / MOUNTING KIT



Çelik  
Steel

**200648**  
Ayak/Bracket



Çelik  
Steel

**200642**  
Kuşak/Strap

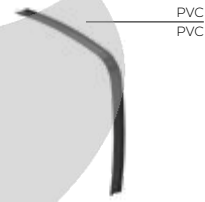

PVC  
PVC

**000297**  
Kuşak Lastiği/Strap Rubber



Çelik  
Steel

**204431**  
Pim Takımı/Pim Sets



PVC  
PVC

**000956**  
Depo Kapağı/Tank Cap

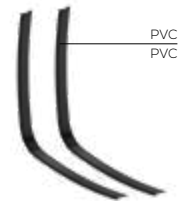

PVC  
PVC

**000326**  
Ayak Takozu/Bracket Rubber

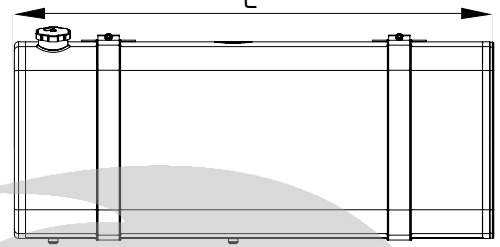
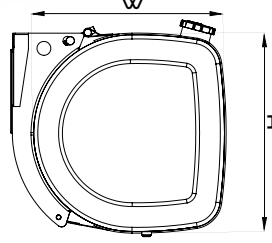

Seri No Serial No	Yükseklik (mm) Height (mm)	Genişlik (mm) Width (mm)	Uzunluk (mm) Length (mm)	Hacim (lt) Capacity (lt)
KTS 6971 065	690	710	650	280
KTS 6971 076	690	710	760	300
KTS 6971 090	690	710	900	400
KTS 6971 107	690	710	1070	450
KTS 6971 123	690	710	1230	550
KTS 6971 150	690	710	1500	650

**MONTAJ KITI / MOUNTING KIT**

 Çelik  
 Steel

 Çelik  
 Steel

 PVC  
 PVC

**203980**  
 Ayak/Bracket

**203985**  
 Kuşak/Strap

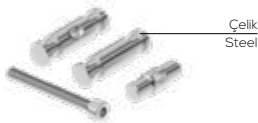
**002024**  
 Kuşak Lastiği/Strap Rubber

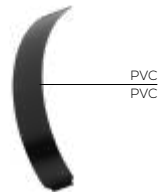
 Çelik  
 Steel

 PVC  
 PVC

 PVC  
 PVC

**204432**  
 Pim Takımı/Pim Sets

**000956**  
 Depo Kapağı/Tank Cap

**002025**  
 Ayak Takozu/Bracket Rubber



**KLÖTZE**  
TECHNIC

STEEL  
FUEL  
TANKS  
71X71

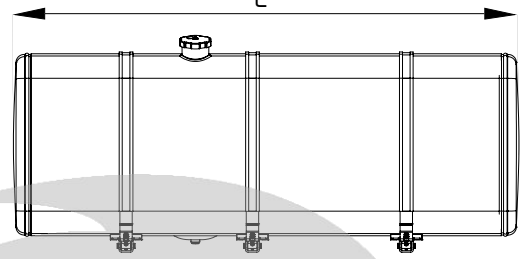
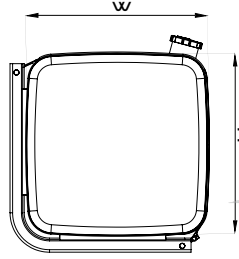

Seri No Serial No	Yükseklik (mm) Height (mm)	Genişlik (mm) Width (mm)	Uzunluk (mm) Length (mm)	Hacim (lt) Capacity (lt)
KTS 7171 068	710	710	680	300
KTS 7171 087	710	710	875	370
KTS 7171 093	710	710	930	400
KTS 7171 106	710	710	1060	450
KTS 7171 113	710	710	1130	490
KTS 7171 121	710	710	1210	525
KTS 7171 136	710	710	1360	580
KTS 7171 143	710	710	1430	605

MONTAJ KITI / MOUNTING KIT



Çelik  
Steel

**201305**  
Ayak/Bracket



Çelik  
Steel

**200050**  
Kuşak/Strap

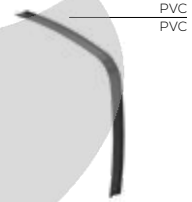

PVC  
PVC

**200284**  
Kuşak Lastiği/Strap Rubber

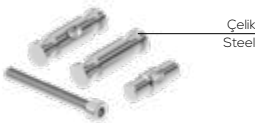

Çelik  
Steel

**201767**  
Pim Takımı/Pim Sets



PVC  
PVC

**000956**  
Depo Kapagı/Tank Cap

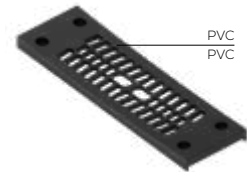

PVC  
PVC

**001555**  
Ayak Takozu/Bracket Rubber



**KLÖTZE**  
TECHNIC

STEEL  
FUEL  
TANKS  
73X73

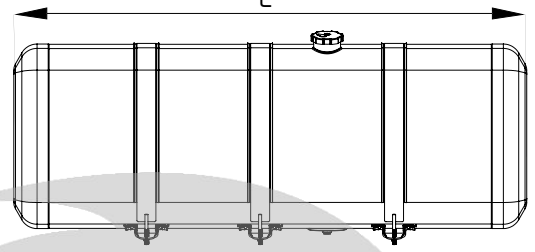
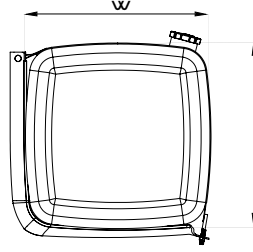

Seri No Serial No	Yükseklik (mm) Height (mm)	Genişlik (mm) Width (mm)	Uzunluk (mm) Length (mm)	Hacim (lt) Capacity (lt)
KTS 7373 084	730	730	840	400
KTS 7373 105	730	730	1050	495
KTS 7373 120	730	730	1200	580

MONTAJ KITI / MOUNTING KIT



Çelik  
Steel

**204451**  
Ayak/Bracket



Çelik  
Steel

**204452**  
Kuşak/Strap

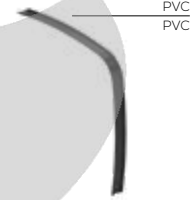

PVC  
PVC

**000297**  
Kuşak Lastiği/Strap Rubber



Çelik  
Steel

**204453**  
Pim Takımı/Pin Sets



PVC  
PVC

**000956**  
Depo Kapağı/Tank Cap

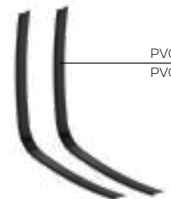

PVC  
PVC

**001951**  
Ayak Takozu/Bracket Rubber





**KLÖTZE**  
TECHNIC

STEEL  
FUEL  
TANKS  
75X75

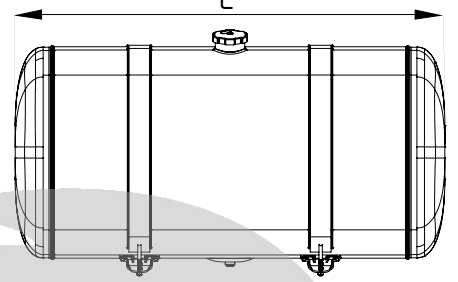
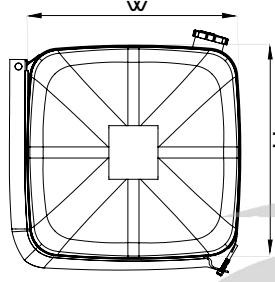

Seri No Serial No	Yükseklik (mm) Height (mm)	Genişlik (mm) Width (mm)	Uzunluk (mm) Length (mm)	Hacim (lt) Capacity (lt)
KTS 7575 100	750	750	1000	540
KTS 7575 125	750	750	1250	650
KTS 7575 150	750	750	1500	780

MONTAJ KITI / MOUNTING KIT



Çelik  
Steel

**203803**  
Ayak/Bracket



Çelik  
Steel

**203802**  
Kuşak/Strap

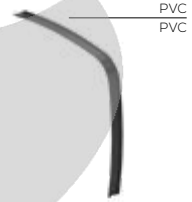

PVC  
PVC

**002169**  
Kuşak Lastiği/Strap Rubber



Çelik  
Steel

**204453**  
Pim Takımı/Pim Sets



PVC  
PVC

**000956**  
Depo Kapağı/Tank Cap

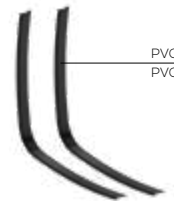

PVC  
PVC

**001951**  
Ayak Takozu/Bracket Rubber



**KLÖTZE**  
TECHNIC

STEEL  
FUEL  
TANKS  
76X80

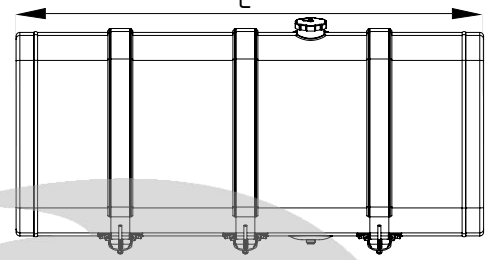
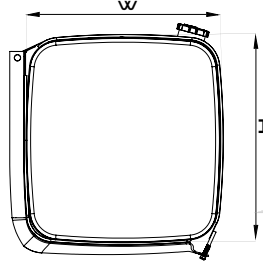

**Seri No**  
Serial No

**Yükseklik (mm)**  
Height (mm)

**Genişlik (mm)**  
Width (mm)

**Uzunluk (mm)**  
Length (mm)

**Hacim (lt)**  
Capacity (lt)

KTS 7680 100

800

760

1000

585

**MONTAJ KITI / MOUNTING KIT**



**204441**  
Ayak/Bracket



**203945**  
Kuşak/Strap

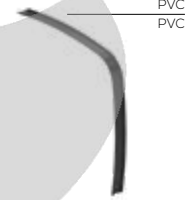

**001998**  
Kuşak Lastiği/Strap Rubber



**204453**  
Pim Takımı/Pim Sets



**000956**  
Depo Kapagı/Tank Cap

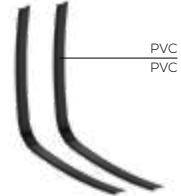

**001951**  
Ayak Takozu/Bracket Rubber



**KLÖTZE**  
TECHNIC

STEEL  
OIL  
TANKS  
**20X70**  
REAR MOUNTED

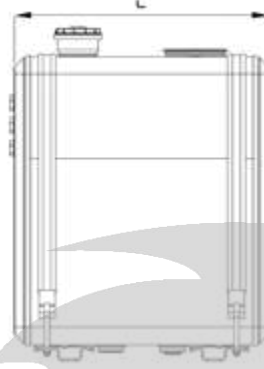
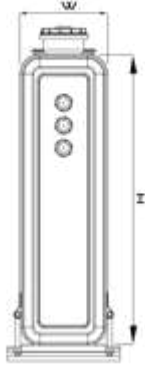

Seri No Serial No	Yükseklik (mm) Height (mm)	Genişlik (mm) Width (mm)	Uzunluk (mm) Length (mm)	Hacim (lt) Capacity (lt)
KTR 2070 070	700	200	700	100
KTR 2070 085	700	200	850	130
KTR 2070 100	700	200	1000	150
KTR 2070 120	700	200	1200	190

MONTAJ KITI / MOUNTING KIT



Çelik  
Steel

**204456**  
Ayak/Bracket



Çelik  
Steel

**204458**  
Kuşak/Strap

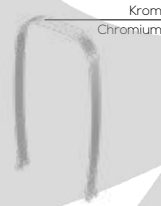

Krom  
Chromium

**204457**  
Kuşak/Strap



PVC  
PVC

**001784**  
Kuşak Lastiği/Strap Rubber



PVC  
PVC

**200446**  
Depo Kapagı/Tank Cap



PVC  
PVC

**001557**  
Ayak Takozu/Bracket Rubber

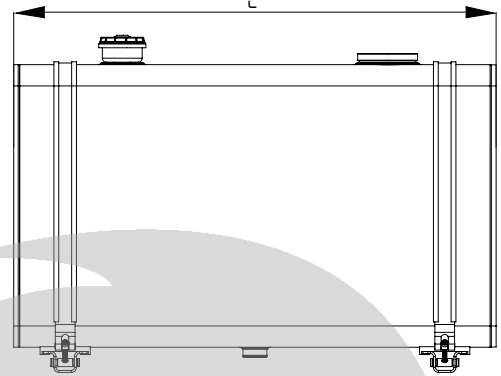
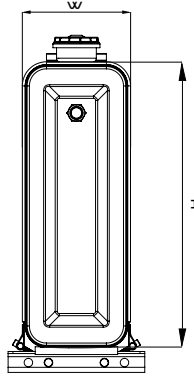

Seri No Serial No	Yükseklik (mm) Height (mm)	Genişlik (mm) Width (mm)	Uzunluk (mm) Length (mm)	Hacim (lt) Capacity (lt)
KTR 2570 070	700	250	700	100
KTR 2570 085	700	250	850	130
KTR 2570 100	700	250	1000	150
KTR 2570 120	700	250	1200	190

**MONTAJ KITI / MOUNTING KIT**

**200494**  
 Ayak/Bracket

**200223**  
 Kuşak/Strap

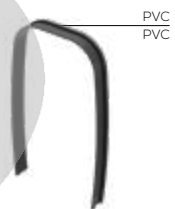
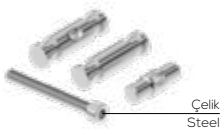
**201902**  
 Kuşak/Strap

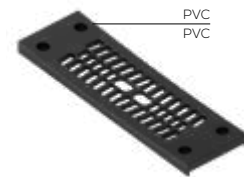
**001688**  
 Kuşak Lastiği/Strap Rubber

**201557**  
 Pim Takımı/Pim Sets

**200446**  
 Depo Kapağı/Tank Cap

**001557**  
 Ayak Takoğu/Bracket Rubber



**KLÖTZE**  
TECHNIC

STEEL  
OIL  
TANKS  
28X70

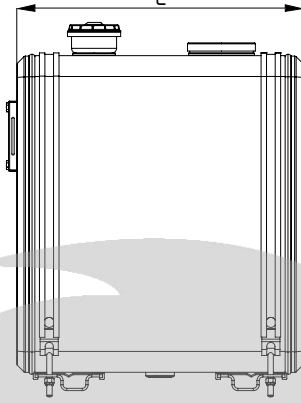
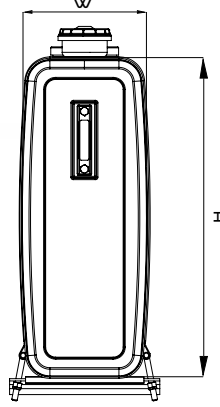
REAR MOUNTED



Seri No Serial No	Yükseklik (mm) Height (mm)	Genişlik (mm) Width (mm)	Uzunluk (mm) Length (mm)	Hacim (lt) Capacity (lt)
KTR 2870 055	700	280	550	100
KTR 2870 062	700	280	620	110
KTR 2870 125	700	280	1250	225
KTR 2870 133	700	280	1330	235

MONTAJ KITI / MOUNTING KIT



Çelik  
Steel

**204285**  
Ayak/Bracket



Çelik  
Steel

**203722**  
Kuşak/Strap

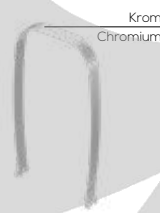

Krom  
Chromium

**204283**  
Kuşak/Strap

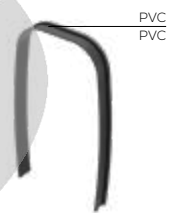

PVC  
PVC

**001194**  
Kuşak Lastiği/Strap Rubber



PVC  
PVC

**200446**  
Depo Kapağı/Tank Cap



PVC  
PVC

**00185**  
Ayak Takozu/Bracket Rubber



**KLÖTZE**  
TECHNIC

STEEL  
OIL  
TANKS  
**31X41**

REAR MOUNTED

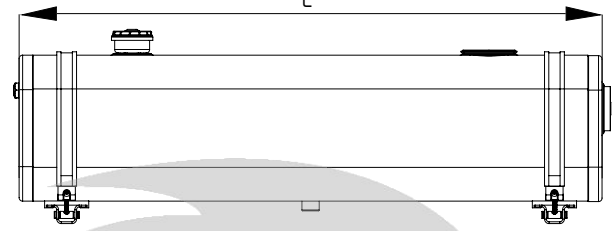
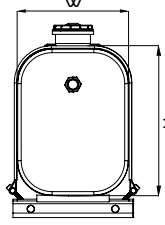

Seri No Serial No	Yükseklik (mm) Height (mm)	Genişlik (mm) Width (mm)	Uzunluk (mm) Length (mm)	Hacim (lt) Capacity (lt)
KTR 3141 060	410	310	600	65
KTR 3141 075	410	310	750	75
KTR 3141 115	410	310	1150	125
KTR 3141 140	410	310	1400	150

MONTAJ KITI / MOUNTING KIT



**200494**  
Ayak/Bracket

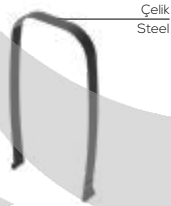

**200198**  
Kuşak/Strap

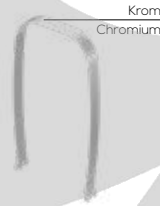

**201613**  
Kuşak/Strap

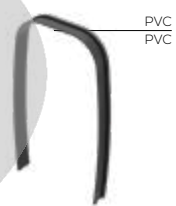

**001689**  
Kuşak Lastiği/Strap Rubber

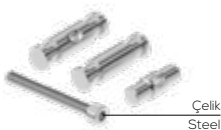

**201557**  
Pim Takımı/Pim Sets



**200446**  
Depo Kapağı/Tank Cap



**001557**  
Ayak Takozu/Bracket Rubber



**KLÖTZE**  
TECHNIC

STEEL  
OIL  
TANKS  
**31X51**

REAR MOUNTED

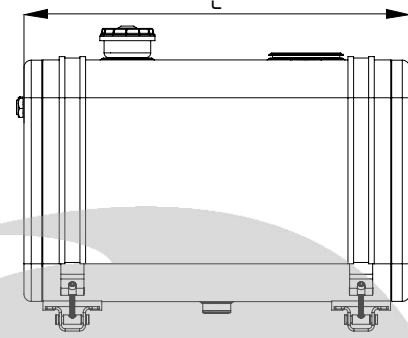
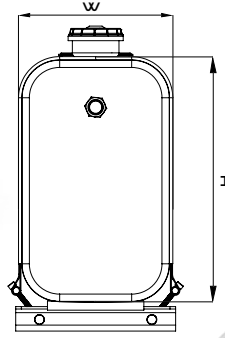

Seri No Serial No	Yükseklik (mm) Height (mm)	Genişlik (mm) Width (mm)	Uzunluk (mm) Length (mm)	Hacim (lt) Capacity (lt)
KTR 3151 068	510	310	680	90
KTR 3151 077	510	310	770	100
KTR 3151 085	510	310	850	110
KTR 3151 100	510	310	1000	135
KTR 3151 110	510	310	1100	150
KTR 3151 125	510	310	1250	180

MONTAJ KITI / MOUNTING KIT



**200494**  
Ayak/Bracket

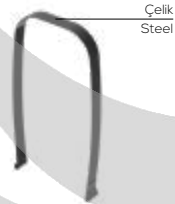

**200898**  
Kuşak/Strap



**201163**  
Kuşak/Strap



**000711**  
Kuşak Lastiği/Strap Rubber

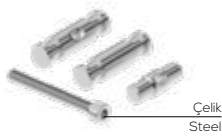

**201557**  
Pim Takımı/Pim Sets



**200446**  
Depo Kapağı/Tank Cap

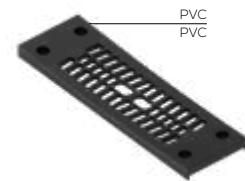

**001557**  
Ayak Takozu/Bracket Rubber



**KLÖTZE**  
TECHNIC

STEEL  
OIL  
TANKS  
**35X35**

REAR MOUNTED

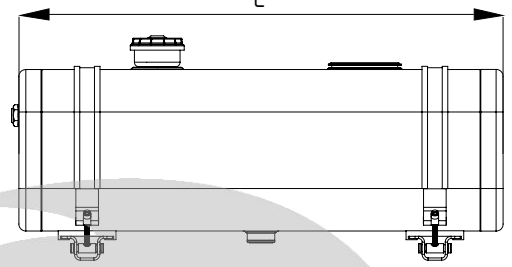
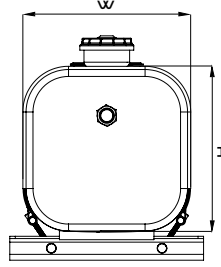

Seri No Serial No	Yükseklik (mm) Height (mm)	Genişlik (mm) Width (mm)	Uzunluk (mm) Length (mm)	Hacim (lt) Capacity (lt)
KTR 3535 065	350	350	650	75
KTR 3535 100	350	350	1000	115
KTR 3535 130	350	350	1300	150
KTR 3535 160	350	350	1600	190

MONTAJ KITI / MOUNTING KIT



Çelik  
Steel

**200117**  
Ayak/Bracket



Çelik  
Steel

**200119**  
Kuşak/Strap

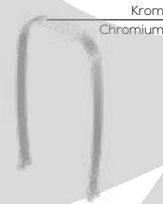

Krom  
Chromium

**200172**  
Kuşak/Strap

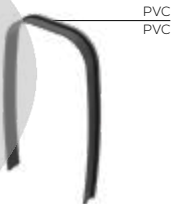

PVC  
PVC

**001693**  
Kuşak Lastiği/Strap Rubber

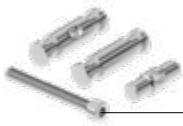

Çelik  
Steel

**201557**  
Pim Takımı/Pim Sets



PVC  
PVC

**200446**  
Depo Kapağı/Tank Cap



PVC  
PVC

**001557**  
Ayak Takoğu/Bracket Rubber





**KLÖTZE**  
TECHNIC

STEEL  
OIL  
TANKS  
**32X65**

REAR MOUNTED

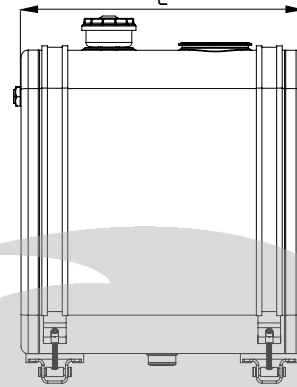
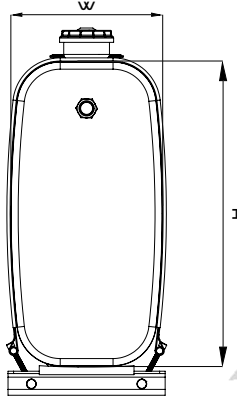

Seri No Serial No	Yükseklik (mm) Height (mm)	Genişlik (mm) Width (mm)	Uzunluk (mm) Length (mm)	Hacim (lt) Capacity (lt)
KTR 3265 065	650	320	650	120
KTR 3265 090	650	320	900	170
KTR 3265 110	650	320	1100	205
KTR 3265 125	650	320	1250	235

MONTAJ KITI / MOUNTING KIT



Çelik  
Steel

**200494**  
Ayak/Bracket

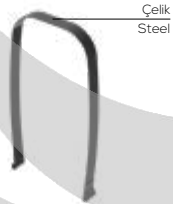

Çelik  
Steel

**200530**  
Kuşak/Strap

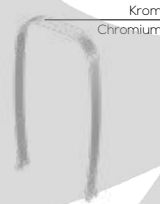

Krom  
Chromium

**200968**  
Kuşak/Strap

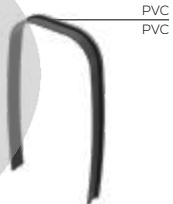

PVC  
PVC

**200391**  
Kuşak Lastiği/Strap Rubber

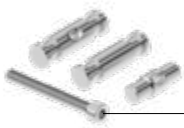

Çelik  
Steel

**201557**  
Pim Takımı/Pim Sets

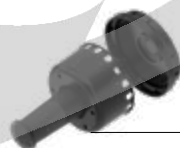

PVC  
PVC

**200446**  
Depo Kapağı/Tank Cap



PVC  
PVC

**001557**  
Ayak Takozu/Bracket Rubber



**KLÖTZE**  
TECHNIC

STEEL  
OIL  
TANKS  
**35X58**

SIDE MOUNTED

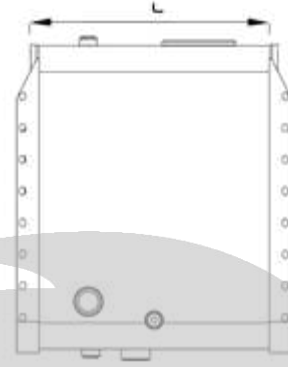
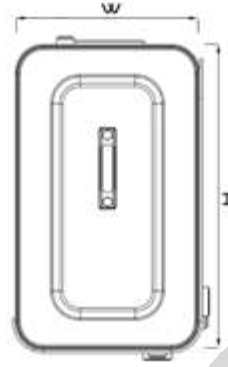

Seri No Serial No	Yükseklik (mm) Height (mm)	Genişlik (mm) Width (mm)	Uzunluk (mm) Length (mm)	Hacim (lt) Capacity (lt)
KTU 3558 047	580	350	470	85
KTU 3558 050	580	350	500	90
KTU 3558 055	580	350	550	100



**KLÖTZE**  
TECHNIC

STEEL  
OIL  
TANKS  
**42X52**  
REAR MOUNTED

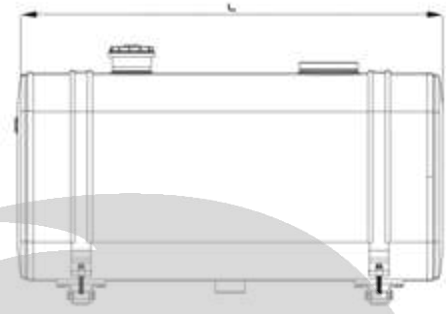

Seri No Serial No	Yükseklik (mm) Height (mm)	Genişlik (mm) Width (mm)	Uzunluk (mm) Length (mm)	Hacim (lt) Capacity (lt)
KTR 4252 079	520	420	790	140
KTR 4252 089	520	420	890	160
KTR 4252 098	520	420	980	180
KTR 4252 110	520	420	1100	200
KTR 4252 125	520	420	1250	230

**MONTAJ KITI / MOUNTING KIT**



**200867**  
Ayak/Bracket



**202470**  
Kuşak/Strap



**202471**  
Kuşak/Strap



**001784**  
Kuşak Lastiği/Strap Rubber

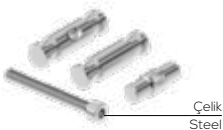

**201557**  
Pim Takımı/Pin Sets



**200446**  
Depo Kapağı/Tank Cap



**001557**  
Ayak Takozu/Bracket Rubber



**KLÖTZE**  
TECHNIC

STEEL  
OIL  
TANKS  
**42X52**  
SIDE MOUNTED

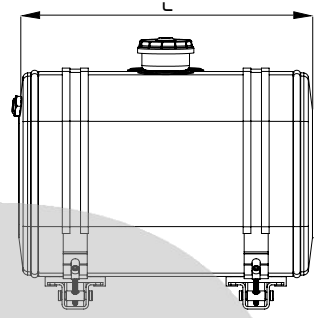
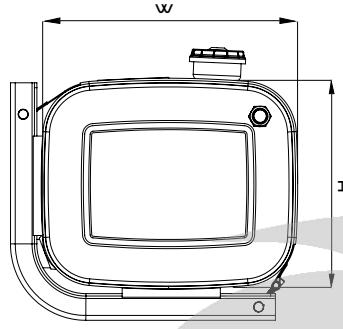

Seri No Serial No	Yükseklik (mm) Height (mm)	Genişlik (mm) Width (mm)	Uzunluk (mm) Length (mm)	Hacim (lt) Capacity (lt)
KTU 4252 040	420	520	400	75
KTU 4252 050	420	520	500	90
KTU 4252 060	420	520	600	110

MONTAJ KITI / MOUNTING KIT



Çelik  
Steel

**201009**  
Ayak/Bracket

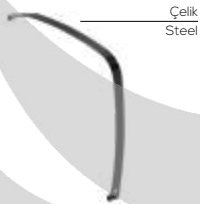

Çelik  
Steel

**202468**  
Kuşak/Strap



Krom  
Chromium

**202469**  
Kuşak/Strap

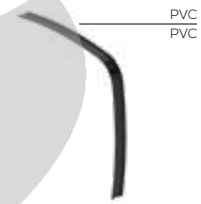

PVC  
PVC

**001620**  
Kuşak Lastiği/Strap Rubber

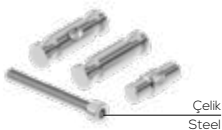

Çelik  
Steel

**201302**  
Pim Takımı/Pim Sets



PVC  
PVC

**200446**  
Depo Kapağı/Tank Cap

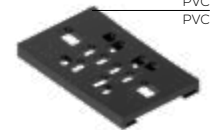

PVC  
PVC

**001557**  
Ayak Takozu/Bracket Rubber



**KLÖTZE**  
TECHNIC

STEEL  
OIL  
TANKS

**50X56**

**SIDE MOUNTED**

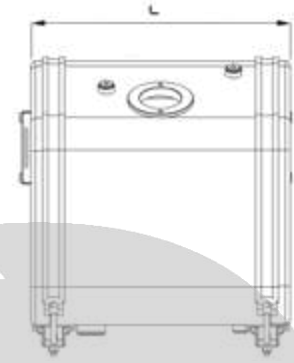

Seri No Serial No	Yükseklik (mm) Height (mm)	Genişlik (mm) Width (mm)	Uzunluk (mm) Length (mm)	Hacim (lt) Capacity (lt)
KTU 5056 050	560	500	500	125
KTU 5056 060	560	500	600	150
KTU 5056 065	560	500	650	160

**MONTAJ KITI / MOUNTING KIT**



Çelik  
Steel



Krom  
Chromium



PVC  
PVC

**203228-203229**  
Ayak/Bracket

**001753**  
Kuşak/Strap

**001648**  
Kuşak Lastiği/Strap Rubber

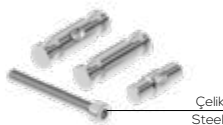

Çelik  
Steel



PVC  
PVC

**204463**  
Pim Takımı/Pim Sets

**001650-001651**  
Ayak Takozu/Bracket Rubber



**KLÖTZE**  
TECHNIC

STEEL

OIL

TANKS

**56X64**

SIDE MOUNTED

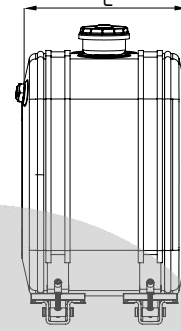
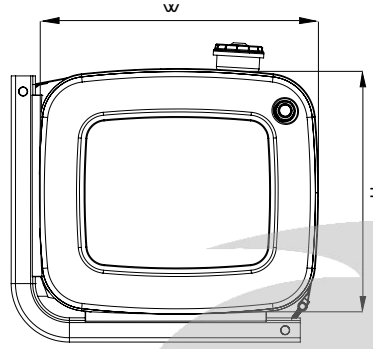

Seri No Serial No	Yükseklik (mm) Height (mm)	Genişlik (mm) Width (mm)	Uzunluk (mm) Length (mm)	Hacim (lt) Capacity (lt)
KTU 5664 040	560	640	400	120
KTU 5664 050	560	640	500	160
KTU 5664 060	560	640	600	190

**MONTAJ KITI / MOUNTING KIT**



Çelik  
Steel

**201126**  
Ayak/Bracket



Çelik  
Steel

**200225**  
Kuşak/Strap



Krom  
Chromium

**201174**  
Kuşak/Strap

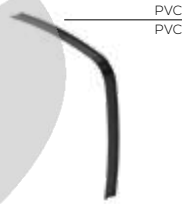

PVC  
PVC

**001643**  
Kuşak Lastiği/Strap Rubber

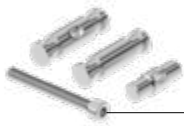

Çelik  
Steel

**201302**  
Pim Takımı/Pim Sets



PVC  
PVC

**200446**  
Depo Kapağı/Tank Cap



PVC  
PVC

**001555**  
Ayak Takozu/Bracket Rubber



**KLÖTZE**  
TECHNIC

STEEL  
OIL  
TANKS  
**62X67**  
SIDE MOUNTED

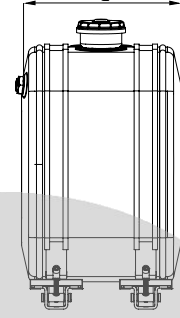
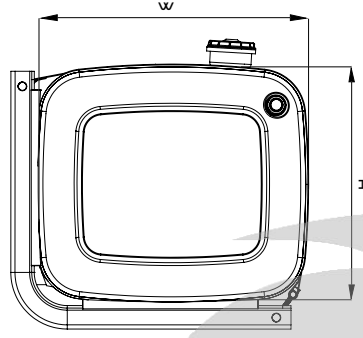

Seri No Serial No	Yükseklik (mm) Height (mm)	Genişlik (mm) Width (mm)	Uzunluk (mm) Length (mm)	Hacim (lt) Capacity (lt)
KTU 6267 040	620	675	400	150
KTU 6267 050	620	675	500	180
KTU 6267 060	620	675	600	220

MONTAJ KITI / MOUNTING KIT



Çelik  
Steel

**201014**  
Ayak/Bracket



Çelik  
Steel

**200224**  
Kuşak/Strap



Krom  
Chromium

**200173**  
Kuşak/Strap

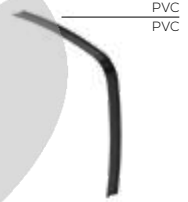

PVC  
PVC

**000711**  
Kuşak Lastiği/Strap Rubber

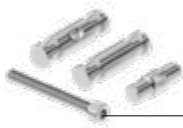

Çelik  
Steel

**201302**  
Pim Takımı/Pim Sets



PVC  
PVC

**200446**  
Depo Kapağı/Tank Cap

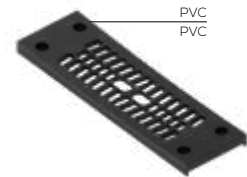

PVC  
PVC

**001555**  
Ayak Takoğu/Bracket Rubber



**KLÖTZE**  
TECHNIC

STEEL  
OIL  
TANKS  
**63X70**  
SIDE MOUNTED

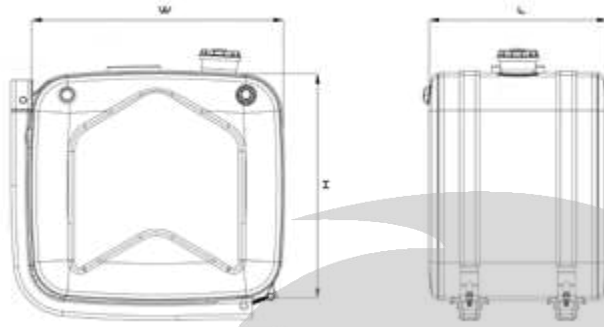

Seri No Serial No	Yükseklik (mm) Height (mm)	Genişlik (mm) Width (mm)	Uzunluk (mm) Length (mm)	Hacim (lt) Capacity (lt)
KTU 6370 040	630	700	400	165
KTU 6370 042	630	700	420	175
KTU 6370 050	630	700	500	210
KTU 6370 060	630	700	600	250

**MONTAJ KITI / MOUNTING KIT**



Çelik  
Steel

**204175**  
Ayak/Bracket



Çelik  
Steel

**204454**  
Kuşak/Strap



Krom  
Chromium

**204176**  
Kuşak/Strap

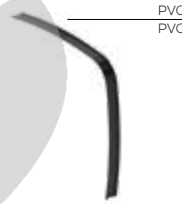

PVC  
PVC

**002127**  
Kuşak Lastiği/Strap Rubber

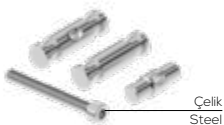

Çelik  
Steel

**204455**  
Pim Takımı/Pin Sets



PVC  
PVC

**200446**  
Depo Kapağı/Tank Cap



PVC  
PVC

**000455**  
Ayak Takozu/Bracket Rubber





**KLÖTZE**  
TECHNIC

STEEL  
OIL  
TANKS  
**63X70**

SIDE MOUNTED

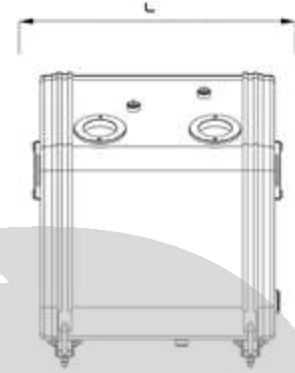

Seri No Serial No	Yükseklik (mm) Height (mm)	Genişlik (mm) Width (mm)	Uzunluk (mm) Length (mm)	Hacim (lt) Capacity (lt)
KTU 6370 050	700	630	500	195
KTU 6370 060	700	630	600	230
KTU 6370 065	700	630	650	250

MONTAJ KITI / MOUNTING KIT



Çelik  
Steel

**203230**  
Ayak/Bracket



Krom  
Chromium

**001754**  
Kuşak/Strap



PVC  
PVC

**001649**  
Kuşak Lastiği/Strap Rubber

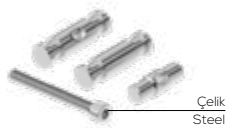

Çelik  
Steel

**204463**  
Pim Takımı/Pin Sets



PVC  
PVC

**001652-001653**  
Ayak Takozu/Bracket Rubber



**KLÖTZE**  
TECHNIC

STEEL  
OIL  
TANKS  
**69X69**  
SIDE MOUNTED

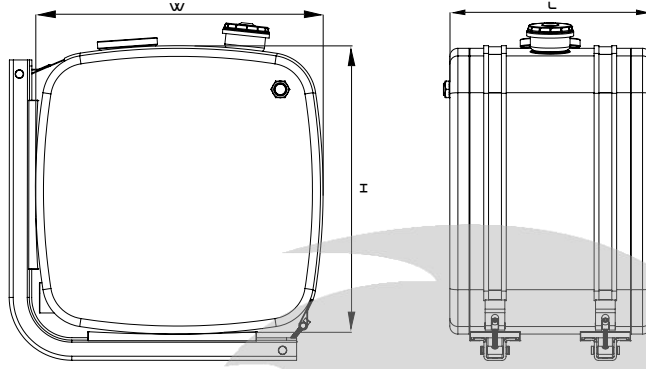

Seri No Serial No	Yükseklik (mm) Height (mm)	Genişlik (mm) Width (mm)	Uzunluk (mm) Length (mm)	Hacim (lt) Capacity (lt)
KTU 6969 040	690	690	400	160
KTU 6969 050	690	690	500	200
KTU 6969 060	690	690	600	240

MONTAJ KITI / MOUNTING KIT



Çelik  
Steel

**201127**  
Ayak/Bracket



Çelik  
Steel

**200816**  
Kuşak/Strap



Krom  
Chromium

**202168**  
Kuşak/Strap

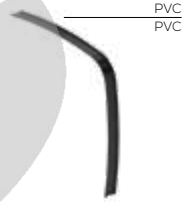

PVC  
PVC

**201922**  
Kuşak Lastiği/Strap Rubber

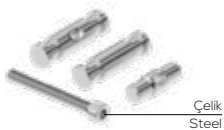

Çelik  
Steel

**201302**  
Pim Takımı/Pin Sets



PVC  
PVC

**200446**  
Depo Kapağı/Tank Cap

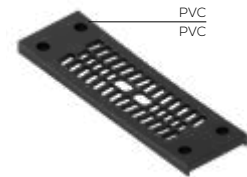

PVC  
PVC

**001555**  
Ayak Takozu/Bracket Rubber



**KLÖTZE**  
TECHNIC

STEEL  
OIL  
TANKS  
71X71

SIDE MOUNTED

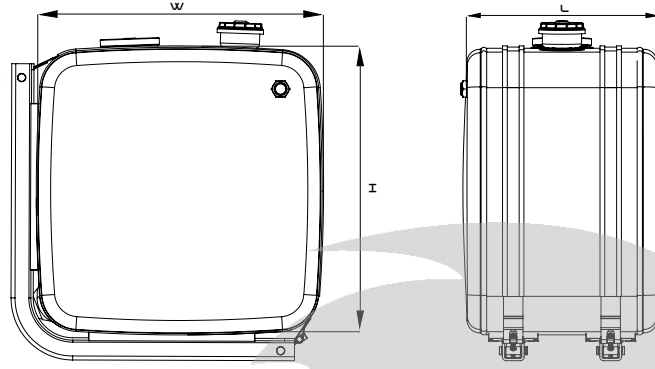

Seri No Serial No	Yükseklik (mm) Height (mm)	Genişlik (mm) Width (mm)	Uzunluk (mm) Length (mm)	Hacim (lt) Capacity (lt)
KTU 7171 040	710	710	400	195
KTU 7171 050	710	710	500	245
KTU 7171 060	710	710	600	295

MONTAJ KITI / MOUNTING KIT



Çelik  
Steel

**201127**  
Ayak/Bracket

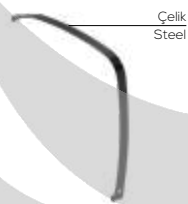

Çelik  
Steel

**200318**  
Kuşak/Strap



Krom  
Chromium

**202084**  
Kuşak/Strap

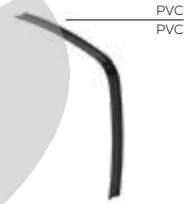

PVC  
PVC

**200319**  
Kuşak Lastiği/Strap Rubber

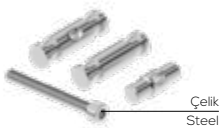

Çelik  
Steel

**201302**  
Pim Takımı/Pim Sets



PVC  
PVC

**200446**  
Depo Kapağı/Tank Cap



PVC  
PVC

**001555**  
Ayak Takozu/Bracket Rubber



**KLÖTZE**  
TECHNIC

STEEL  
OIL  
TANKS  
Ø400

SIDE MOUNTED

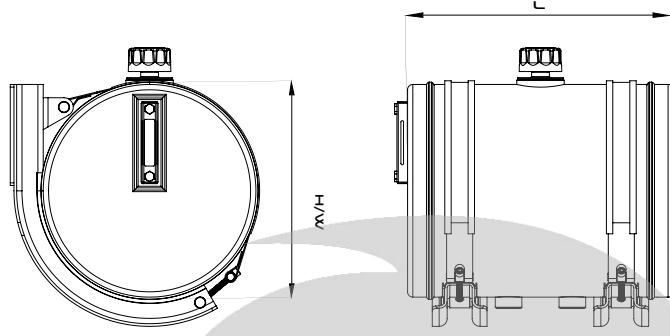

Seri No Serial No	Yükseklik (mm) Height (mm)	Genişlik (mm) Width (mm)	Uzunluk (mm) Length (mm)	Hacim (lt) Capacity (lt)
KTU 400 035		Ø400	350	40
KTU 400 050		Ø400	500	60
KTU 400 065		Ø400	650	80
KTU 400 080		Ø400	800	100
KTU 400 100		Ø400	1000	120

MONTAJ KITI / MOUNTING KIT



**203422**  
Ayak/Bracket

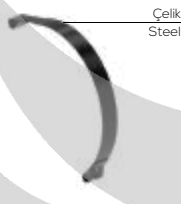

**204433**  
Kuşak/Strap



**203423**  
Kuşak/Strap



**204434**  
Kuşak Lastiği/Strap Rubber

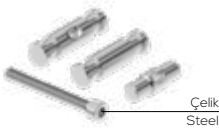

**201302**  
Pim Takımı/Pim Sets



**000274**  
Depo Kapağı/Tank Cap



**204435**  
Ayak Lastiği/Bracket Rubber



**KLÖTZE**  
TECHNIC

STEEL  
OIL  
TANKS  
Ø550

SIDE MOUNTED

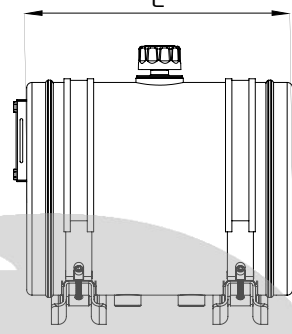
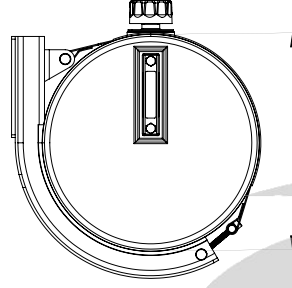

Seri No Serial No	Yükseklik (mm) Height (mm)	Genişlik (mm) Width (mm)	Uzunluk (mm) Length (mm)	Hacim (lt) Capacity (lt)
KTU 550 027		Ø550	270	60
KTU 550 035		Ø550	350	80
KTU 550 052		Ø550	520	120
KTU 550 065		Ø550	650	150
KTU 550 085		Ø550	850	200

MONTAJ KITI / MOUNTING KIT



**203427**  
Ayak/Bracket

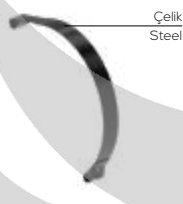

**202468**  
Kuşak/Strap



**202682**  
Kuşak/Strap



**001690**  
Kuşak Lastiği/Strap Rubber

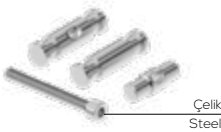

**201302**  
Pim Takımı/Pim Sets



**000274**  
Depo Kapağı/Tank Cap



**204436**  
Ayak Lastiği/Bracket Rubber



**KLÖTZE**  
TECHNIC

STEEL  
OIL  
TANKS  
Ø625  
SIDE MOUNTED

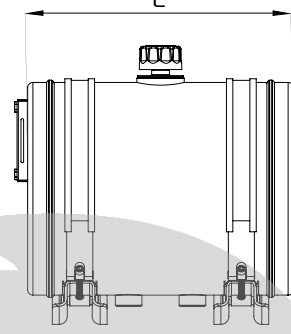
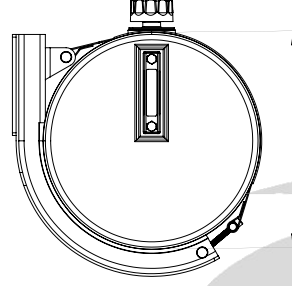

Seri No Serial No	Yükseklik (mm) Height (mm)	Genişlik (mm) Width (mm)	Uzunluk (mm) Length (mm)	Hacim (lt) Capacity (lt)
KTU 625 045		Ø625	450	130
KTU 625 055		Ø625	550	160
KTU 625 070		Ø625	700	200
KTU 625 077		Ø625	770	230
KTU 625 085		Ø625	850	250

MONTAJ KITI / MOUNTING KIT



**202967**  
Ayak/Bracket

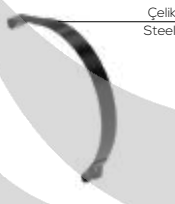

**200225**  
Kuşak/Strap

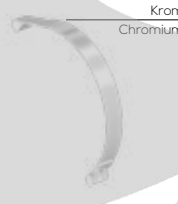

**202990**  
Kuşak/Strap



**001643**  
Kuşak Lastiği/Strap Rubber

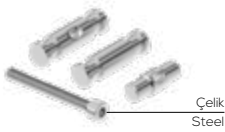

**201302**  
Pim Takımı/Pim Sets



**000274**  
Depo Kapağı/Tank Cap



**204436**  
Ayak Lastiği/Bracket Rubber



**KLÖTZE**  
TECHNIC

STEEL  
OIL  
TANKS  
Ø660  
SIDE MOUNTED

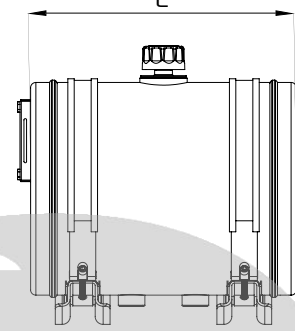
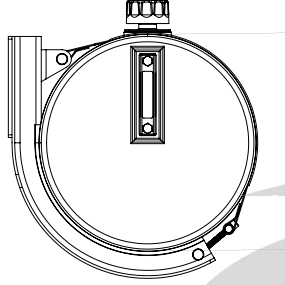

Seri No Serial No	Yükseklik (mm) Height (mm)	Genişlik (mm) Width (mm)	Uzunluk (mm) Length (mm)	Hacim (lt) Capacity (lt)
KTU 660 045		Ø660	450	150
KTU 660 055		Ø660	550	180
KTU 660 065		Ø660	650	220
KTU 660 075		Ø660	750	250
KTU 660 090		Ø660	900	300

MONTAJ KITI / MOUNTING KIT



**203424**  
Ayak/Bracket

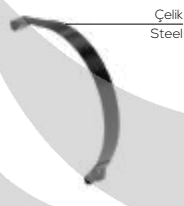

**204438**  
Kuşak/Strap

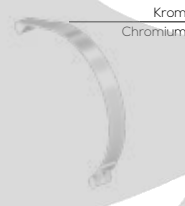

**203425**  
Kuşak/Strap

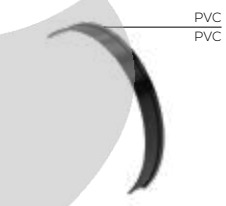

**204439**  
Kuşak Lastiği/Strap Rubber

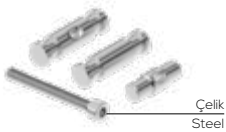

**201302**  
Pim Takımı/Pim Sets

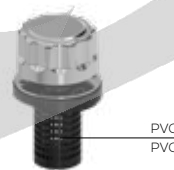

**000274**  
Depo Kapağı/Tank Cap



**204440**  
Ayak Lastiği/Bracket Rubber



**KLÖTZE**  
TECHNIC

ALUMINIUM  
AIR TANKS  
Ø210

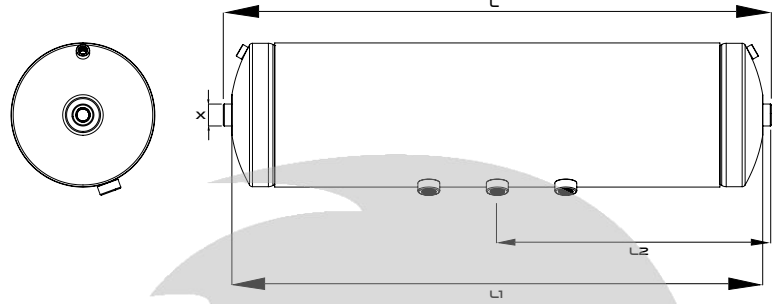

Seri No Serial No	Hacim (lt) Capacity (lt)	Ø Çap (mm) Ø Diameter (mm)	L	L1	L2	X	Çalışma Basıncı (Bar) Working Pressure
KA 210 020	20	Ø210	522	500	261	M22X1,5	12,5
KA 210 025	25	Ø210	622	600	311	M22X1,5	12,5
KA 210 030	30	Ø210	722	700	361	M22X1,5	12,5





**KLÖTZE**  
TECHNIC

ALUMINIUM  
AIR TANKS  
Ø256

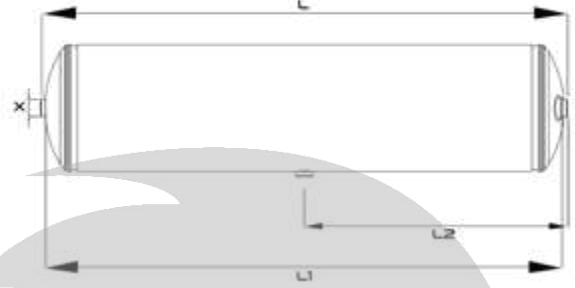
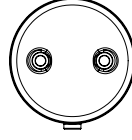

Seri No Serial No	Hacim (lt) Capacity (lt)	Ø Çap (mm) Ø Diameter (mm)	L	L1	L2	X	Çalışma Basıncı (Bar) Working Pressure
KA 256 020	20	Ø256	522	500	261	M22X1,5	12,5
KA 256 025	25	Ø256	622	600	311	M22X1,5	12,5
KA 256 030	30	Ø256	722	700	361	M22X1,5	12,5



**KLÖTZE**  
TECHNIC

ALUMINIUM  
AIR TANKS  
Ø396

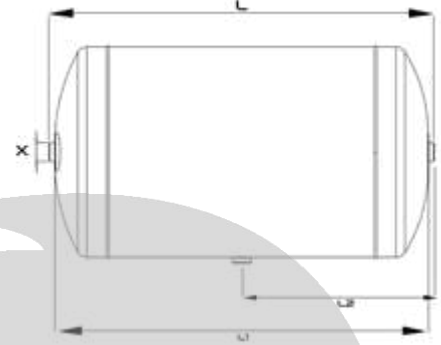
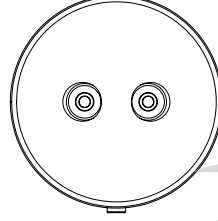

Seri No Serial No	Hacim (lt) Capacity (lt)	Ø Çap (mm) Ø Diameter (mm)	L	L1	L2	X	Çalışma Basıncı (Bar) Working Pressure
KA 396 060	60	Ø396	567	545	283,5	M22X1,5	12,5
KA 396 080	80	Ø396	722	700	361	M22X1,5	12,5
KA 396 100	100	Ø396	872	850	436	M22X1,5	12,5



TRUCK **SPARE PARTS**



**KLÖTZE**  
TECHNIC

[www.klotzetechnik.de](http://www.klotzetechnik.de)

Gesuchte Europäische  
**Qualität**

**Klötze Technic** ist ein in Deutschland ansässiger Hersteller und Lieferant von LKW-, Anhänger- und Bus-Ersatzteilen.

FOLLOW  
US

**#KLOTZETECHNIC**