

TRUCK **SPARE PARTS**

Gesuchte Europäische Qualität

SPARE PARTS

sought-after
quality

HYDRAULIC EQUIPMENT



KLÖTZE
TECHNIC

www.klotzetechnik.de

Klötze Technic ist ein in Deutschland ansässiger Hersteller und Lieferant von LKW-, Anhänger- und Bus-Ersatzteilen.



KLÖTZE
TECHNIC

Gesuchte Europäische
Qualität

Klötze Technic is a Germany-based company specializing in truck, trailer, and bus spare parts. Together with our sales office in Turkey, we provide our customers with original spare parts of guaranteed quality. Our products are manufactured with superior German engineering.

Our main groups consist of Engine, Cooling System, Fuel System, Exhaust System, Clutch & Pedal, Gearbox, Propeller Shaft, Axles, Brake System, Hubs & Wheels, Suspension, Steering, Electrical System, Cabin, and Body.

At Klötze Technic, we strive to provide our customers with the highest quality products, competitive prices, and superior customer service.

Our Mission:

At Klötze Technic, we work to provide our customers with the highest quality and reliable spare parts for trucks, trailers, and buses.

Our high-quality products are manufactured with superior German engineering.

Our mission is to meet our customers' needs and provide them with the best customer service possible.

Our Vision:

At Klötze Technic, we aim to become a world-leading company in the field of truck, trailer, and bus spare parts.

Our vision is to provide our customers with the highest quality products, competitive prices, and superior customer service. In doing so, we aim to meet our customers' needs and ensure their satisfaction.

Our Quality Policy:

At Klötze Technic, quality and customer satisfaction are always our top priorities. Our products are manufactured with superior German engineering and are provided to our customers as original spare parts of guaranteed quality. Our quality policy is to provide our customers with the best quality products and meet their needs in the best way possible.

Customer satisfaction is always important to us.

TRUCK SPARE PARTS



KLÖTZE
TECHNIC

Gesuchte Europäische
Qualität



TRUCK SPARE PARTS

www.klotzetechnik.de





KLÖTZE
TECHNIC

www.klotzetechnik.de





KT No.

Replaces Ref. No:

Description

Model / Details



20 SERIES ISO - 4 BOLTS LEFT AND RIGHT GEAR PUMP

Product Number Ürün Numarası	Displacement İletim Hacmi (cm /rev at 1000 rpm)	Max. Pressure Maks.Basınç (bar)	Max.Speed Maks. Hız	Inlet Giriş	Outlet Çıkış	Weight Ağırlık (Kg.)
KT50001	6,10	280	2200	G 1/2"	G 1/2"	6
KT50002	10,20	280	2200	G 1/2"	G 1/2"	6,5
KT50003	16,20	280	2200	G 1/2"	G 1/2"	7
KT50004	20,20	260	2200	G 1/2"	G 1/2"	7,4
KT50005	25,30	220	2200	G 3/4"	G 3/4"	7,6
KT50006	32,30	190	2000	G 3/4"	G 3/4"	8
KT50007	40,10	180	2000	G 3/4"	G 3/4"	8,5



20 SERIES UNI - 3 BOLTS LEFT AND RIGHT GEAR PUMP

Product Number Ürün Numarası	Displacement İletim Hacmi (cm /rev at 1000 rpm)	Max. Pressure Maks.Basınç (bar)	Max.Speed Maks. Hız	Inlet Giriş	Outlet Çıkış	Weight Ağırlık (Kg.)
KT50008	6,10	280	2200	G 1/2"	G 1/2"	5
KT50009	10,20	280	2200	G 1/2"	G 1/2"	5,5
KT50010	16,20	280	2200	G 1/2"	G 1/2"	5,8
KT50011	20,20	260	2200	G 1/2"	G 1/2"	6
KT50012	25,30	220	2200	G 3/4"	G 3/4"	6,1
KT50013	32,30	190	2000	G 3/4"	G 3/4"	6,3
KT50014	40,10	180	2000	G 3/4"	G 3/4"	6,5



20 SERIES IP1 - 4 BOLTS LEFT AND RIGHT GEAR PUMP

Product Number Ürün Numarası	Displacement İletim Hacmi (cm /rev at 1000 rpm)	Max. Pressure Maks.Basınç (bar)	Max.Speed Maks. Hız	Inlet Giriş	Outlet Çıkış	Weight Ağırlık (Kg.)
KT50015	6,10	280	2200	4020M8	3013M6	5
KT50016	10,20	280	2200	4020M8	3013M6	5,5
KT50017	16,20	280	2200	4020M8	3013M6	5,8
KT50018	20,20	260	2200	4020M8	3013M6	6
KT50019	25,30	220	2200	4020M8	3013M6	6,1
KT50020	32,30	190	2000	4020M8	3013M6	6,3
KT50021	40,10	180	2000	4020M8	3013M6	6,5





30 SERIES ISO LEFT AND RIGHT GEAR PUMP

Product Number Ürün Numarası	Displacement İletim Hacmi (cm ³ /rev at 1000 rpm)	Max. Pressure Maks.Basınç (bar)	Max.Speed Maks. Hız	Inlet Giriş	Outlet Çıkış	Weight Ağırlık (Kg.)
KT50358	14,10	300	2700	G 1/2"	G 1/2"	11
KT50359	17,20	300	2700	G 1/2"	G 1/2"	11,5
KT50360	22,10	300	2700	G 3/4"	G 1/2"	12
KT50361	27,05	300	2700	G 3/4"	G 1/2"	12,5
KT50362	34,30	285	2400	G 3/4"	G 3/4"	12,8
KT50363	38,10	285	2200	G 3/4"	G 3/4"	13
KT50364	43,20	270	2200	G 3/4"	G 3/4"	13,3
KT50365	51,60	240	2200	G 1"	G 3/4"	13,5
KT50366	61,80	220	1800	G 1"	G 1"	14
KT50367	67,40	220	1800	G 1"	G 1"	14,2
KT50368	73,10	210	1600	G 1 1/4"	G 1"	14,5
KT50369	82,05	200	1500	G 1 1/4"	G 1"	14,7
KT50370	92,10	200	1500	G 1 1/4"	G 1"	14,8
KT50371	100,20	180	1500	G 1 1/4"	G 1"	15
KT50372	125,60	160	1500	G 1 1/4"	G 1"	15,3



30 SERIES UNI LEFT AND RIGHT GEAR PUMP

Product Number Ürün Numarası	Displacement İletim Hacmi (cm ³ /rev at 1000 rpm)	Max. Pressure Maks.Basınç (bar)	Max.Speed Maks. Hız	Inlet Giriş	Outlet Çıkış	Weight Ağırlık (Kg.)
KT50373	14	300	2700	G 1/2"	G 1/2"	8,5
KT50374	17,20	300	2700	G 1/2"	G 1/2"	9
KT50375	22,10	300	2700	G 3/4"	G 1/2"	9,5
KT50376	27,05	300	2700	G 3/4"	G 1/2"	10
KT50377	34,30	285	2400	G 3/4"	G 3/4"	10,5
KT50378	38,10	285	2200	G 3/4"	G 3/4"	10,8
KT50379	43,20	270	2200	G 3/4"	G 3/4"	11
KT50380	51,60	240	2200	G 1"	G 3/4"	11,5
KT50381	61,80	220	1800	G 1"	G 1"	12
KT50382	67,40	220	1800	G 1"	G 1"	12
KT50383	73,10	210	1600	G 1 1/4"	G 1"	12,5
KT50384	82,05	200	1500	G 1 1/4"	G 1"	13
KT50385	92,10	200	1500	G 1 1/4"	G 1"	14,8
KT50386	100,20	180	1500	G 1 1/4"	G 1"	15
KT50387	125,60	160	1500	G 1 1/4"	G 1"	15,3



KT No.

Replaces Ref. No:

Description

Model / Details

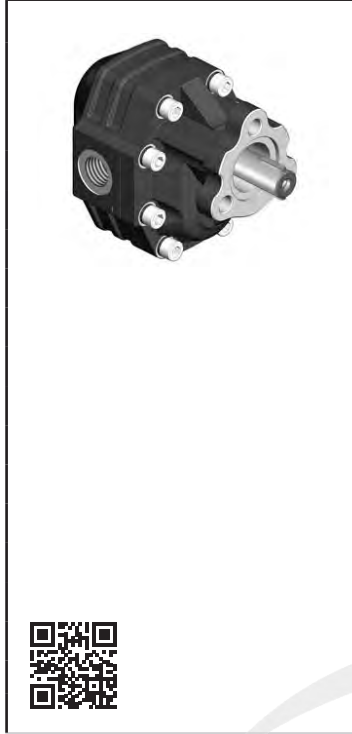
**30 SERIES UNI 22K LEFT AND RIGHT GEAR PUMP**

Product Number Ürün Numarası	Displacement İletim Hacmi (cm /rev at 1000 rpm)	Max. Pressure Maks.Basınç (bar)	Max.Speed Maks. Hız	Inlet Giriş	Outlet Çıkış	Weight Ağırlık (Kg.)
KT50022	14	300	2700	G 1/2"	G 1/2"	8,5
KT50023	17,20	300	2700	G 1/2"	G 1/2"	9
KT50024	22,10	300	2700	G 3/4"	G 1/2"	9,5
KT50025	27,05	300	2700	G 3/4"	G 1/2"	10
KT50026	34,30	285	2400	G 3/4"	G 3/4"	10,5
KT50027	38,10	285	2200	G 3/4"	G 3/4"	10,8
KT50028	43,20	270	2200	G 3/4"	G 3/4"	11
KT50029	51,60	240	2200	G 1"	G 3/4"	11,5
KT50030	61,80	220	1800	G 1"	G 1"	12
KT50031	67,40	220	1800	G 1"	G 1"	12
KT50032	73,10	210	1600	G 1 1/4"	G 1"	12,5
KT50033	82,05	200	1500	G 1 1/4"	G 1"	13
KT50034	92,10	200	1500	G 1 1/4"	G 1"	14,8
KT50035	100,20	180	1500	G 1 1/4"	G 1"	15
KT50036	125,60	160	1500	G 1 1/4"	G 1"	15,3

**30 SERIES SAEB13 LEFT AND RIGHT GEAR PUMP**

Product Number Ürün Numarası	Displacement İletim Hacmi (cm /rev at 1000 rpm)	Max. Pressure Maks.Basınç (bar)	Max.Speed Maks. Hız	Inlet Giriş	Outlet Çıkış	Weight Ağırlık (Kg.)
KT50037	14	300	2700	G 1/2"	G 1/2"	9,5
KT50038	17,20	300	2700	G 1/2"	G 1/2"	10
KT50039	22,10	300	2700	G 3/4"	G 1/2"	10,5
KT50040	27,05	300	2700	G 3/4"	G 1/2"	11
KT50041	34,30	285	2400	G 3/4"	G 3/4"	11,5
KT50042	38,10	285	2200	G 3/4"	G 3/4"	11,8
KT50043	43,20	270	2200	G 3/4"	G 3/4"	12
KT50044	51,60	240	2200	G 1"	G 3/4"	12,5
KT50045	61,80	220	1800	G 1"	G 1"	13
KT50046	67,40	220	1800	G 1"	G 1"	13
KT50047	73,10	210	1600	G 1 1/4"	G 1"	13,5
KT50048	82,05	200	1500	G 1 1/4"	G 1"	14,7
KT50049	92,10	200	1500	G 1 1/4"	G 1"	14,8
KT50050	100,20	180	1500	G 1 1/4"	G 1"	15
KT50051	125,60	160	1500	G 1 1/4"	G 1"	15,3





30 SERIES SAEB15 LEFT AND RIGHT GEAR PUMP

Product Number Ürün Numarası	Displacement İletim Hacmi (cm /rev at 1000 rpm)	Max. Pressure Maks.Basınç (bar)	Max.Speed Maks. Hız	Inlet Giriş	Outlet Çıkış	Weight Ağırlık (Kg.)
KT50388	14	300	2700	G 1/2"	G 1/2"	9,5
KT50389	17,20	300	2700	G 1/2"	G 1/2"	10
KT50390	22,10	300	2700	G 3/4"	G 1/2"	10,5
KT50391	27,05	300	2700	G 3/4"	G 1/2"	11
KT50392	34,30	285	2400	G 3/4"	G 3/4"	11,5
KT50393	38,10	285	2200	G 3/4"	G 3/4"	11,8
KT50394	43,20	270	2200	G 3/4"	G 3/4"	12
KT50395	51,60	240	2200	G 1"	G 3/4"	12,5
KT50396	61,80	220	1800	G 1"	G 1"	13
KT50397	67,40	220	1800	G 1"	G 1"	13
KT50398	73,10	210	1600	G 1 1/4"	G 1"	13,5
KT50399	82,05	200	1500	G 1 1/4"	G 1"	14,7
KT50400	92,10	200	1500	G 1 1/4"	G 1"	14,8
KT50401	100,20	180	1500	G 1 1/4"	G 1"	15
KT50402	125,60	160	1500	G 1 1/4"	G 1"	15,3



30 SERIES SAEB22K LEFT AND RIGHT GEAR PUMP

Product Number Ürün Numarası	Displacement İletim Hacmi (cm /rev at 1000 rpm)	Max. Pressure Maks.Basınç (bar)	Max.Speed Maks. Hız	Inlet Giriş	Outlet Çıkış	Weight Ağırlık (Kg.)
KT50403	14	300	2700	G 1/2"	G 1/2"	9,5
KT50404	17,20	300	2700	G 1/2"	G 1/2"	10
KT50405	22,10	300	2700	G 3/4"	G 1/2"	10,5
KT50406	27,05	300	2700	G 3/4"	G 1/2"	11
KT50407	34,30	285	2400	G 3/4"	G 3/4"	11,5
KT50408	38,10	285	2200	G 3/4"	G 3/4"	11,8
KT50409	43,20	270	2200	G 3/4"	G 3/4"	12
KT50410	51,60	240	2200	G 1"	G 3/4"	12,5
KT50411	61,80	220	1800	G 1"	G 1"	13
KT50412	67,40	220	1800	G 1"	G 1"	13
KT50413	73,10	210	1600	G 1 1/4"	G 1"	13,5
KT50414	82,05	200	1500	G 1 1/4"	G 1"	14,7
KT50415	92,10	200	1500	G 1 1/4"	G 1"	14,8
KT50416	100,20	180	1500	G 1 1/4"	G 1"	15
KT50417	125,60	160	1500	G 1 1/4"	G 1"	15,3





KT No.

Replaces Ref. No:

Description

Model / Details

 QR Code	30 SERIES ISO 13/8 ASAE LEFT AND RIGHT GEAR PUMP						
	Product Number Ürün Numarası	Displacement İletim Hacmi (cm ³ /rev at 1000 rpm)	Max. Pressure Maks.Basınç (bar)	Max.Speed Maks. Hız	Inlet Giriş	Outlet Çıkış	Weight Ağırlık (Kg.)
	KT50052	14	300	2700	G 1/2"	G 1/2"	11
	KT50053	17,20	300	2700	G 1/2"	G 1/2"	11,5
	KT50054	22,10	300	2700	G 3/4"	G 1/2"	12
	KT50055	27,05	300	2700	G 3/4"	G 1/2"	12,5
	KT50056	34,30	285	2400	G 3/4"	G 3/4"	12,8
	KT50057	38,10	285	2200	G 3/4"	G 3/4"	13
	KT50058	43,20	270	2200	G 3/4"	G 3/4"	13,3
	KT50059	51,60	240	2200	G 1"	G 3/4"	13,5
	KT50060	61,80	220	1800	G 1"	G 1"	14
	KT50061	67,40	220	1800	G 1"	G 1"	14,2
	KT50062	73,10	210	1600	G 1 1/4"	G 1"	14,5
	KT50063	82,05	200	1500	G 1 1/4"	G 1"	14,7
	KT50064	92,10	200	1500	G 1 1/4"	G 1"	14,8
	KT50065	100,20	180	1500	G 1 1/4"	G 1"	15
	KT50066	125,60	160	1500	G 1 1/4"	G 1"	15,3

 QR Code	30 SERIES TPK LEFT AND RIGHT GEAR PUMP						
	Product Number Ürün Numarası	Displacement İletim Hacmi (cm ³ /rev at 1000 rpm)	Max. Pressure Maks.Basınç (bar)	Max.Speed Maks. Hız	Inlet Giriş	Outlet Çıkış	Weight Ağırlık (Kg.)
	KT50067	22,10	300	2700	5125M10	4019M8	11
	KT50068	27,05	300	2700	5125M10	4019M8	11,5
	KT50069	34,30	285	2400	5125M10	4019M8	12
	KT50070	38,10	285	2200	5125M10	4019M8	12,5
	KT50071	43,20	270	2200	5125M10	4019M8	12,8
	KT50072	51,60	240	2200	5125M10	4019M8	13
	KT50073	61,60	220	1800	5125M10	4019M8	15,3

 QR Code	30 SERIES UNI MECHANIC VALVE LEFT AND RIGHT GEAR PUMP						
	Product Number Ürün Numarası	Displacement İletim Hacmi (cm ³ /rev at 1000 rpm)	Max. Pressure Maks.Basınç (bar)	Max.Speed Maks. Hız	Inlet Giriş	Outlet Çıkış	Weight Ağırlık (Kg.)
	KT50074	43,20	270	2200	G 3/4"	G 3/4"	13
	KT50075	61,80	220	1800	G 1"	G 1"	14
	KT50076	82,05	200	1500	G 1 1/4"	G 1"	15,7





30 SERIES ISO BI-DIRECTIONAL GEAR PUMP

Product Number Ürün Numarası	Displacement İletim Hacmi (cm ³ /rev at 1000 rpm)	Max. Pressure Maks.Basınç (bar)	Max.Speed Maks. Hız	Inlet Giriş	Outlet Çıkış	Weight Ağırlık (Kg.)
KT50418	14	300	2700	G 1/2"	G 1/2"	11
KT50419	17,20	300	2700	G 1/2"	G 1/2"	11,5
KT50420	22,10	300	2700	G 1/2"	G 1/2"	12
KT50421	27,05	300	2700	G 1/2"	G 1/2"	12,5
KT50422	34,30	285	2400	G 3/4"	G 3/4"	12,8
KT50423	38,10	285	2200	G 3/4"	G 3/4"	13
KT50424	43,20	270	2200	G 3/4"	G 3/4"	13,3
KT50425	51,60	240	2200	G 3/4"	G 3/4"	13,5
KT50426	61,80	220	1800	G 1"	G 1"	14
KT50427	67,40	220	1800	G 1"	G 1"	14,2
KT50428	73,10	210	1600	G 1"	G 1"	14,5
KT50429	82,05	200	1500	G 1"	G 1"	14,7
KT50430	92,10	200	1500	G 1"	G 1"	14,8
KT50431	100,20	180	1500	G 1 1/4"	G 1 1/4"	15
KT50432	125,60	160	1500	G 1 1/4"	G 1 1/4"	15,3



30 SERIES UNI BI-DIRECTIONAL GEAR PUMP

Product Number Ürün Numarası	Displacement İletim Hacmi (cm ³ /rev at 1000 rpm)	Max. Pressure Maks.Basınç (bar)	Max.Speed Maks. Hız	Inlet Giriş	Outlet Çıkış	Weight Ağırlık (Kg.)
KT50433	14	300	2700	G 1/2"	G 1/2"	8,5
KT50434	17,20	300	2700	G 1/2"	G 1/2"	9
KT50435	22,10	300	2700	G 1/2"	G 1/2"	9,5
KT50436	27,05	300	2700	G 1/2"	G 1/2"	10
KT50437	34,30	285	2400	G 3/4"	G 3/4"	10,5
KT50438	38,10	285	2200	G 3/4"	G 3/4"	10,8
KT50439	43,20	270	2200	G 3/4"	G 3/4"	11
KT50440	51,60	240	2200	G 3/4"	G 3/4"	11,5
KT50441	61,80	220	2100	G 1"	G 1"	12
KT50442	67,40	220	2100	G 1"	G 1"	12
KT50443	73,10	210	2100	G 1"	G 1"	12,5
KT50444	82,05	200	1800	G 1"	G 1"	13
KT50445	92,10	200	1800	G 1"	G 1"	14,8
KT50446	100,20	180	1700	G 1 1/4"	G 1 1/4"	15
KT50447	125,60	160	1700	G 1 1/4"	G 1 1/4"	15,3



KT No.

Replaces Ref. No:

Description

Model / Details

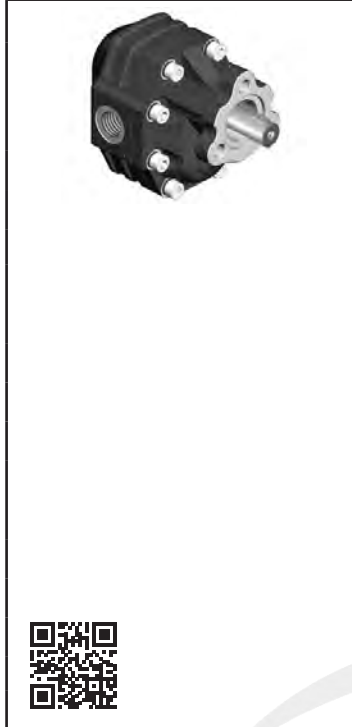
**30 SERIES UNI22K BI-DIRECTIONAL GEAR PUMP**

Product Number Ürün Numarası	Displacement İletim Hacmi (cm /rev at 1000 rpm)	Max. Pressure Maks.Basınç (bar)	Max.Speed Maks. Hız	Inlet Giriş	Outlet Çıkış	Weight Ağırlık (Kg.)
KT50077	14	300	2700	G 1/2"	G 1/2"	8,5
KT50078	17,20	300	2700	G 1/2"	G 1/2"	9
KT50079	22,10	300	2700	G 1/2"	G 1/2"	9,5
KT50080	27,05	300	2700	G 1/2"	G 1/2"	10
KT50081	34,30	285	2400	G 3/4"	G 3/4"	10,5
KT50082	38,10	285	2200	G 3/4"	G 3/4"	10,8
KT50083	43,20	270	2200	G 3/4"	G 3/4"	11
KT50084	51,60	240	2200	G 3/4"	G 3/4"	11,5
KT50085	61,80	220	1800	G 1"	G 1"	12
KT50086	67,40	220	1800	G 1"	G 1"	12
KT50087	73,10	210	1600	G 1"	G 1"	12,5
KT50088	82,05	200	1500	G 1"	G 1"	13
KT50089	92,10	200	1500	G 1"	G 1"	14,8
KT50090	100,20	180	1500	G 1 1/4"	G 1 1/4"	15
KT50091	125,60	160	1500	G 1 1/4"	G 1 1/4"	15,3

**30 SERIES SAEB13 BI-DIRECTIONAL GEAR PUMP**

Product Number Ürün Numarası	Displacement İletim Hacmi (cm /rev at 1000 rpm)	Max. Pressure Maks.Basınç (bar)	Max.Speed Maks. Hız	Inlet Giriş	Outlet Çıkış	Weight Ağırlık (Kg.)
KT50092	14	300	2700	G 1/2"	G 1/2"	9,5
KT50093	17,20	300	2700	G 1/2"	G 1/2"	10
KT50094	22,10	300	2700	G 1/2"	G 1/2"	10,5
KT50095	27,05	300	2700	G 1/2"	G 1/2"	11
KT50096	34,30	285	2400	G 3/4"	G 3/4"	11,5
KT50097	38,10	285	2200	G 3/4"	G 3/4"	11,8
KT50098	43,20	270	2200	G 3/4"	G 3/4"	12
KT50099	51,60	240	2200	G 3/4"	G 3/4"	12,5
KT50100	61,80	220	1800	G 1"	G 1"	13
KT50101	67,40	220	1800	G 1"	G 1"	13
KT50102	73,10	210	1600	G 1"	G 1"	13,5
KT50103	82,05	200	1500	G 1"	G 1"	14,7
KT50104	92,10	200	1500	G 1"	G 1"	14,8
KT50105	100,20	180	1500	G 1 1/4"	G 1 1/4"	15
KT50106	125,60	160	1500	G 1 1/4"	G 1 1/4"	15,3





30 SERIES SAEB15 BI-DIRECTIONAL GEAR PUMP

Product Number Ürün Numarası	Displacement İletim Hacmi (cm /rev at 1000 rpm)	Max. Pressure Maks.Basınç (bar)	Max.Speed Maks. Hız	Inlet Giriş	Outlet Çıkış	Weight Ağırlık (Kg.)
KT50448	14	300	2700	G 1/2"	G 1/2"	9,5
KT50449	17,20	300	2700	G 1/2"	G 1/2"	10
KT50450	22,10	300	2700	G 1/2"	G 1/2"	10,5
KT50451	27,05	300	2700	G 1/2"	G 1/2"	11
KT50452	34,30	285	2400	G 3/4"	G 3/4"	11,5
KT50453	38,10	285	2200	G 3/4"	G 3/4"	11,8
KT50454	43,20	270	2200	G 3/4"	G 3/4"	12
KT50455	51,60	240	2200	G 3/4"	G 3/4"	12,5
KT50456	61,80	220	1800	G 1"	G 1"	13
KT50457	67,40	220	1800	G 1"	G 1"	13
KT50458	73,10	210	1600	G 1"	G 1"	13,5
KT50459	82,05	200	1500	G 1"	G 1"	14,7
KT50460	92,10	200	1500	G 1"	G 1"	14,8
KT50461	100,20	180	1500	G 1 1/4"	G 1 1/4"	15
KT50462	125,60	160	1500	G 1 1/4"	G 1 1/4"	15,3



30 SERIES SAEB22K BI-DIRECTIONAL GEAR PUMP

Product Number Ürün Numarası	Displacement İletim Hacmi (cm /rev at 1000 rpm)	Max. Pressure Maks.Basınç (bar)	Max.Speed Maks. Hız	Inlet Giriş	Outlet Çıkış	Weight Ağırlık (Kg.)
KT50463	14	300	2700	G 1/2"	G 1/2"	9,5
KT50464	17,20	300	2700	G 1/2"	G 1/2"	10
KT50465	22,10	300	2700	G 1/2"	G 1/2"	10,5
KT50466	27,05	300	2700	G 1/2"	G 1/2"	11
KT50467	34,30	285	2400	G 3/4"	G 3/4"	11,5
KT50468	38,10	285	2200	G 3/4"	G 3/4"	11,8
KT50469	43,20	270	2200	G 3/4"	G 3/4"	12
KT50470	51,60	240	2200	G 3/4"	G 3/4"	12,5
KT50471	61,80	220	1800	G 1"	G 1"	13
KT50472	67,40	220	1800	G 1"	G 1"	13
KT50473	73,10	210	1600	G 1"	G 1"	13,5
KT50474	82,05	200	1500	G 1"	G 1"	14,7
KT50475	92,10	200	1500	G 1"	G 1"	14,8
KT50476	100,20	180	1500	G 1 1/4"	G 1 1/4"	15
KT50477	125,60	160	1500	G 1 1/4"	G 1 1/4"	15,3



KT No.

Replaces Ref. No:

Description

Model / Details

30 SERIES ISO1 3/8 ASAE BI-DIRECTIONAL GEAR PUMP						
Product Number Ürün Numarası	Displacement İletim Hacmi (cm /rev at 1000 rpm)	Max. Pressure Maks.Basınç (bar)	Max.Speed Maks. Hız	Inlet Giriş	Outlet Çıkış	Weight Ağırlık (Kg.)
KT50107	14	300	2700	G 1/2"	G 1/2"	11
KT50108	17,20	300	2700	G 1/2"	G 1/2"	11,5
KT50109	22,10	300	2700	G 1/2"	G 1/2"	12
KT50110	27,05	300	2700	G 1/2"	G 1/2"	12,5
KT50111	34,30	285	2400	G 3/4"	G 3/4"	12,8
KT50112	38,10	285	2200	G 3/4"	G 3/4"	13
KT50113	43,20	270	2200	G 3/4"	G 3/4"	13,3
KT50114	51,60	240	2200	G 3/4"	G 3/4"	13,5
KT50115	61,80	220	1800	G 1"	G 1"	14
KT50116	67,40	220	1800	G 1"	G 1"	14,2
KT50117	73,10	210	1600	G 1"	G 1"	14,5
KT50118	82,05	200	1500	G 1"	G 1"	14,7
KT50119	92,10	200	1500	G 1"	G 1"	14,8
KT50120	100,20	180	1500	G 1 1/4"	G 1 1/4"	15
KT50121	125,60	160	1500	G 1 1/4"	G 1 1/4"	15,3



30 SERIES ISO TANDEM LEFT AND RIGHT GEAR PUMP						
Product Number Ürün Numarası	Displacement İletim Hacmi (cm /rev at 1000 rpm)	Max. Pressure Maks.Basınç (bar)	Max.Speed Maks. Hız	Inlet Giriş	Outlet Çıkış	Weight Ağırlık (Kg.)
KT50122	17,20	300	2700	G 1/2"	G 1/2"	11,5
KT50123	22,10	290	2700	G 3/4"	G 1/2"	12
KT50124	27,05	290	2700	G 3/4"	G 1/2"	12,5
KT50125	34,30	285	2400	G 3/4"	G 3/4"	12,8
KT50126	38,10	285	2200	G 3/4"	G 3/4"	13
KT50127	43,20	280	2200	G 3/4"	G 3/4"	13,3
KT50128	51,60	240	2200	G 1"	G 3/4"	13,5
KT50129	61,80	230	1800	G 1"	G 1"	14
KT50130	67,40	230	1800	G 1"	G 1"	14,2
KT50131	73,10	210	1600	G 1"	G 1"	14,5
KT50132	82,05	210	1500	G 1 1/4"	G 1"	14,7
KT50133	92,10	205	1500	G 1 1/4"	G 1"	15,5





30 SERIES UNI TANDEM LEFT AND RIGHT GEAR PUMP

Product Number Ürün Numarası	Displacement İletim Hacmi (cm /rev at 1000 rpm)	Max. Pressure Maks.Basınç (bar)	Max.Speed Maks. Hız	Inlet Giriş	Outlet Çıkış	Weight Ağırlık (Kg.)
KT50478	17,20	300	2700	G 1/2"	G 1/2"	11,5
KT50479	22,10	290	2700	G 3/4"	G 1/2"	12
KT50480	27,05	290	2700	G 3/4"	G 1/2"	12,5
KT50481	34,30	285	2400	G 3/4"	G 3/4"	12,8
KT50482	38,10	285	2200	G 3/4"	G 3/4"	13
KT50483	43,20	280	2200	G 3/4"	G 3/4"	13,3
KT50484	51,60	240	2200	G 1"	G 3/4"	13,5
KT50485	61,80	230	1800	G 1"	G 1"	14
KT50486	67,40	230	1800	G 1"	G 1"	14,2
KT50487	73,10	210	1600	G 1 1/4"	G 1"	14,5
KT50488	82,05	210	1500	G 1 1/4"	G 1"	14,7
KT50489	92,10	205	1500	G 1 1/4"	G 1"	15,5



30 SERIES UNI TANDEM 22K LEFT AND RIGHT GEAR PUMP

Product Number Ürün Numarası	Displacement İletim Hacmi (cm /rev at 1000 rpm)	Max. Pressure Maks.Basınç (bar)	Max.Speed Maks. Hız	Inlet Giriş	Outlet Çıkış	Weight Ağırlık (Kg.)
KT50490	17,20	300	2700	G 1/2"	G 1/2"	11,5
KT50491	22,10	290	2700	G 3/4"	G 1/2"	12
KT50492	27,05	290	2700	G 3/4"	G 1/2"	12,5
KT50493	34,30	285	2400	G 3/4"	G 3/4"	12,8
KT50494	38,10	285	2200	G 3/4"	G 3/4"	13
KT50495	43,20	280	2200	G 3/4"	G 3/4"	13,3
KT50496	51,60	240	2200	G 1"	G 3/4"	13,5
KT50497	61,80	230	1800	G 1"	G 1"	14
KT50498	67,40	230	1800	G 1"	G 1"	14,2
KT50499	73,10	210	1600	G 1 1/4"	G 1"	14,5
KT50500	82,05	210	1500	G 1 1/4"	G 1"	14,7
KT50501	92,10	205	1500	G 1 1/4"	G 1"	15,5



30 SERIES SAEB13 TEETH TANDEM LEFT AND RIGHT GEAR PUMP

Product Number Ürün Numarası	Displacement İletim Hacmi (cm /rev at 1000 rpm)	Max. Pressure Maks.Basınç (bar)	Max.Speed Maks. Hız	Inlet Giriş	Outlet Çıkış	Weight Ağırlık (Kg.)
KT50502	17,20	300	2700	G 1/2"	G 1/2"	11,5
KT50503	22,10	290	2700	G 3/4"	G 1/2"	12
KT50504	27,05	290	2700	G 3/4"	G 1/2"	12,5
KT50505	34,30	285	2400	G 3/4"	G 3/4"	12,8
KT50506	38,10	285	2200	G 3/4"	G 3/4"	13
KT50507	43,20	280	2200	G 3/4"	G 3/4"	13,3
KT50508	51,60	240	2200	G 1"	G 3/4"	13,5
KT50509	61,80	230	1800	G 1"	G 1"	14
KT50510	67,40	230	1800	G 1"	G 1"	14,2
KT50511	73,10	210	1600	G 1 1/4"	G 1"	14,5
KT50512	82,05	210	1500	G 1 1/4"	G 1"	14,7
TM50513	92,10	200	1500	G 1 1/4"	G 1"	15,5



KT No.

Replaces Ref. No:

Description

Model / Details

30 SERIES SAEB15 TEETH TANDEM LEFT AND RIGHT GEAR PUMP						
Product Number Ürün Numarası	Displacement İletim Hacmi (cm /rev at 1000 rpm)	Max. Pressure Maks.Basınç (bar)	Max.Speed Maks. Hız	Inlet Giriş	Outlet Çıkış	Weight Ağırlık (Kg.)
KT50134	17,20	300	2700	G 1/2"	G 1/2"	11,5
KT50135	22,10	290	2700	G 3/4"	G 1/2"	12
KT50136	27,05	290	2700	G 3/4"	G 1/2"	12,5
KT50137	34,30	285	2400	G 3/4"	G 3/4"	12,8
KT50138	38,10	285	2200	G 3/4"	G 3/4"	13
KT50139	43,20	280	2200	G 3/4"	G 3/4"	13,3
KT50140	51,60	240	2200	G 1"	G 3/4"	13,5
KT50141	61,80	230	1800	G 1"	G 1"	14
KT50142	67,40	230	1800	G 1"	G 1"	14,2
KT50143	73,10	210	1600	G 1 1/4"	G 1"	14,5
KT50144	82,05	210	1500	G 1 1/4"	G 1"	14,7
KT50145	92,10	200	1500	G 1 1/4"	G 1"	15,5

30 SERIES SAEB22 KEY TANDEM LEFT AND RIGHT GEAR PUMP						
Product Number Ürün Numarası	Displacement İletim Hacmi (cm /rev at 1000 rpm)	Max. Pressure Maks.Basınç (bar)	Max.Speed Maks. Hız	Inlet Giriş	Outlet Çıkış	Weight Ağırlık (Kg.)
KT50146	17,20	300	2700	G 1/2"	G 1/2"	11,5
KT50147	22,10	290	2700	G 3/4"	G 1/2"	12
KT50148	27,05	290	2700	G 3/4"	G 1/2"	12,5
KT50149	34,30	285	2400	G 3/4"	G 3/4"	12,8
KT50150	38,10	285	2200	G 3/4"	G 3/4"	13
KT50151	43,20	280	2200	G 3/4"	G 3/4"	13,3
KT50152	51,60	240	2200	G 1"	G 3/4"	13,5
KT50153	61,80	230	1800	G 1"	G 1"	14
KT50154	67,40	230	1800	G 1"	G 1"	14,2
KT50155	73,10	210	1600	G 1 1/4"	G 1"	14,5
KT50156	82,05	210	1500	G 1 1/4"	G 1"	14,7
KT50157	92,10	205	1500	G 1 1/4"	G 1"	15,5

30 SERIES ISO 1 3/8 ASAE TANDEM LEFT AND RIGHT GEAR PUMP						
Product Number Ürün Numarası	Displacement İletim Hacmi (cm /rev at 1000 rpm)	Max. Pressure Maks.Basınç (bar)	Max.Speed Maks. Hız	Inlet Giriş	Outlet Çıkış	Weight Ağırlık (Kg.)
KT50158	17,20	300	2700	G 1/2"	G 1/2"	11,5
KT50159	22,10	290	2700	G 3/4"	G 1/2"	12
KT50160	27,05	290	2700	G 3/4"	G 1/2"	12,5
KT50161	34,30	285	2400	G 3/4"	G 3/4"	12,8
KT50162	38,10	285	2200	G 3/4"	G 3/4"	13
KT50163	43,20	280	2200	G 3/4"	G 3/4"	13,3
KT50164	51,60	240	2200	G 1"	G 3/4"	13,5
KT50165	61,80	230	1800	G 1"	G 1"	14
KT50166	67,40	230	1800	G 1"	G 1"	14,2
KT50167	73,10	210	1600	G 1 1/4"	G 1"	14,5
KT50168	82,05	210	1500	G 1 1/4"	G 1"	14,7
KT50169	92,10	200	1500	G 1 1/4"	G 1"	15,5





Model / Details

Description

Replaces Ref. No:

KT No.



30 SERIES TPK TANDEM LEFT AND RIGHT GEAR PUMP

Product Number Ürün Numarası	Displacement İletim Hacmi (cm /rev at 1000 rpm)	Max. Pressure Maks.Basınç (bar)	Max.Speed Maks. Hız	Inlet Giriş	Outlet Çıkış	Weight Ağırlık (Kg.)
KT50514	22,10	290	2700	5125M10	4019M8	12
KT50515	27,05	290	2700	5125M10	4019M8	12,5
KT50516	34,30	285	2400	5125M10	4019M8	12,8
KT50517	38,10	285	2200	5125M10	4019M8	13
KT50518	43,20	280	2200	5125M10	4019M8	13,3
KT50519	51,60	240	2200	5125M10	4019M8	13,5
KT50520	61,80	230	2100	5125M10	4019M8	14



30 SERIES UNI22K TANDEM ADAPTER LEFT AND RIGHT GEAR PUMP

Product Number Ürün Numarası	Displacement İletim Hacmi (cm /rev at 1000 rpm)	Max. Pressure Maks.Basınç (bar)	Max.Speed Maks. Hız	Inlet Giriş	Outlet Çıkış	Weight Ağırlık (Kg.)
KT50521	22,10	290	2700	5125M10	4019M8	12
KT50522	27,05	290	2700	5125M10	4019M8	12,5
KT50523	34,30	285	2400	5125M10	4019M8	12,8
KT50524	38,10	285	2200	5125M10	4019M8	13
KT50525	43,20	280	2200	5125M10	4019M8	13,3
KT50526	51,60	240	2200	5125M10	4019M8	13,5
KT50527	61,80	230	2100	5125M10	4019M8	14



30 SERIES SAEB13 TEETH TANDEM ADAPTER LEFT AND RIGHT

Product Number Ürün Numarası	Displacement İletim Hacmi (cm /rev at 1000 rpm)	Max. Pressure Maks.Basınç (bar)	Max.Speed Maks. Hız	Inlet Giriş	Outlet Çıkış	Weight Ağırlık (Kg.)
KT50528	22,10	290	2700	5125M10	4019M8	12
KT50529	27,05	290	2700	5125M10	4019M8	12,5
KT50530	34,30	285	2400	5125M10	4019M8	12,8
KT50531	38,10	285	2200	5125M10	4019M8	13
KT50532	43,20	280	2200	5125M10	4019M8	13,3
KT50533	51,60	240	2200	5125M10	4019M8	13,5
KT50534	61,80	230	2100	5125M10	4019M8	14



30 SERIES SAEB15 TEETH TANDEM ADAPTER LEFT AND RIGHT

Product Number Ürün Numarası	Displacement İletim Hacmi (cm /rev at 1000 rpm)	Max. Pressure Maks.Basınç (bar)	Max.Speed Maks. Hız	Inlet Giriş	Outlet Çıkış	Weight Ağırlık (Kg.)
KT50535	22,10	290	2700	5125M10	4019M8	12
KT50536	27,05	290	2700	5125M10	4019M8	12,5
KT50537	34,30	285	2400	5125M10	4019M8	12,8
KT50538	38,10	285	2200	5125M10	4019M8	13
KT50539	43,20	280	2200	5125M10	4019M8	13,3
KT50540	51,60	240	2200	5125M10	4019M8	13,5
KT50541	61,80	230	2100	5125M10	4019M8	14



KT No.

Replaces Ref. No:

Description

Model / Details



30 SERIES SAEB22KEY TANDEM ADAPTER LEFT AND RIGHT

Product Number Ürün Numarası	Displacement İletim Hacmi (cm /rev at 1000 rpm)	Max. Pressure Maks.Basınç (bar)	Max.Speed Maks. Hız	Inlet Giriş	Outlet Çıkış	Weight Ağırlık (Kg.)
KT50170	22,10	290	2700	5125M10	4019M8	12
KT50171	27,05	290	2700	5125M10	4019M8	12,5
KT50172	34,30	285	2400	5125M10	4019M8	12,8
KT50173	38,10	285	2200	5125M10	4019M8	13
KT50174	43,20	280	2200	5125M10	4019M8	13,3
KT50175	51,60	240	2200	5125M10	4019M8	13,5
KT50176	61,80	230	2100	5125M10	4019M8	14

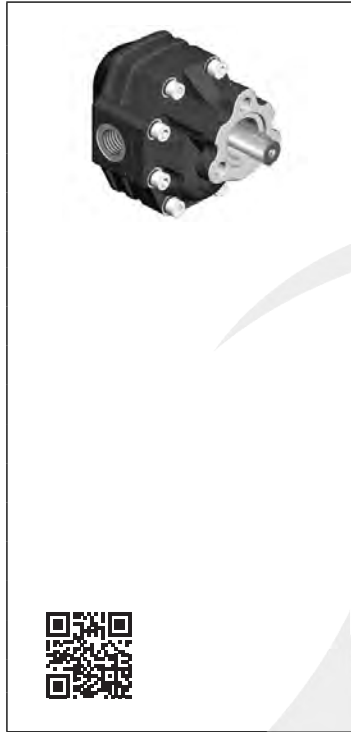

30 SERIES UNI HIDROMOTOR BI-DIRECTIONAL GEAR PUMP

Product Number Ürün Numarası	Displacement İletim Hacmi (cm /rev at 1000 rpm)	Max. Pressure Maks.Basınç (bar)	Max.Speed Maks. Hız	Inlet Giriş	Outlet Çıkış	Weight Ağırlık (Kg.)
KT50177	14	300	2700	G 1/2"	G 1/2"	8,5
KT50178	17,20	300	2700	G 1/2"	G 1/2"	9
KT50179	22,10	300	2700	G 1/2"	G 1/2"	9,5
KT50180	27,05	300	2700	G 1/2"	G 1/2"	10
KT50181	34,30	285	2400	G 3/4"	G 3/4"	10,5
KT50182	38,10	285	2200	G 3/4"	G 3/4"	10,8
KT50183	43,20	270	2200	G 3/4"	G 3/4"	11
KT50184	51,60	240	2200	G 3/4"	G 3/4"	11,5
KT50185	61,80	220	1800	G 1"	G 1"	12
KT50186	67,40	220	1800	G 1"	G 1"	12
KT50187	73,10	210	1600	G 1"	G 1"	12,5
KT50188	82,05	200	1500	G 1"	G 1"	13
KT50189	92,10	200	1500	G 1"	G 1"	14,8
KT50190	100,20	180	1500	G 1 1/4"	G 1 1/4"	15
KT50191	125,60	160	1500	G 1 1/4"	G 1 1/4"	15,3



30 SERIES SAEB BI-DIRECTIONAL GEAR PUMP

Product Number Ürün Numarası	Displacement İletim Hacmi (cm /rev at 1000 rpm)	Max. Pressure Maks.Basınç (bar)	Max.Speed Maks. Hız	Inlet Giriş	Outlet Çıkış	Weight Ağırlık (Kg.)
KT50192	14	300	2700	G 1/2"	G 1/2"	9,5
KT50193	17,20	300	2700	G 1/2"	G 1/2"	10
KT50194	22,10	300	2700	G 1/2"	G 1/2"	10,5
KT50195	27,05	300	2700	G 1/2"	G 1/2"	11
KT50196	34,30	285	2400	G 3/4"	G 3/4"	11,5
KT50197	38,10	285	2200	G 3/4"	G 3/4"	11,8
KT50198	43,20	270	2200	G 3/4"	G 3/4"	12
KT50199	51,60	240	2200	G 3/4"	G 3/4"	12,5
KT50200	61,80	220	1800	G 1"	G 1"	13
KT50201	67,40	220	1800	G 1"	G 1"	13
KT50202	73,10	210	1600	G 1"	G 1"	13,5
KT50203	82,05	200	1500	G 1"	G 1"	14,7
KT50204	92,10	200	1500	G 1"	G 1"	14,8
KT50205	100,20	180	1500	G 1 1/4"	G 1 1/4"	15
KT50206	125,60	160	1500	G 1 1/4"	G 1 1/4"	15,3





KT No.

Replaces Ref. No:

Description

Model / Details

35 SERIES ISO LEFT AND RIGH GEAR PUMP							
Product Number Ürün Numarası	Displacement İletim Hacmi (cm /rev at 1000 rpm)	Max. Pressure Maks.Basınç (bar)	Max.Speed Maks. Hız	Inlet Giriş	Outlet Çıkış	Weight Ağırlık (Kg.)	
KT50207	60,10	260	1800	G1"	G1"	17,1	
KT50208	73,10	255	1800	G1 1/4"	G1"	17,5	
KT50209	90,05	250	1800	G1 1/4"	G1"	18,1	
KT50210	100,30	240	1800	G1 1/4"	G1"	18,4	
KT50211	110,10	230	1800	G1 1/4"	G1"	18,7	
KT50212	125,20	220	1800	G1 1/4"	G1"	19,1	

35 SERIES UNI LEFT AND RIGH GEAR PUMP							
Product Number Ürün Numarası	Displacement İletim Hacmi (cm /rev at 1000 rpm)	Max. Pressure Maks.Basınç (bar)	Max.Speed Maks. Hız	Inlet Giriş	Outlet Çıkış	Weight Ağırlık (Kg.)	
KT50213	60,10	260	1800	G1"	G1"	16,1	
KT50214	73,10	255	1800	G1 1/4"	G1"	16,5	
KT50215	90,05	250	1800	G1 1/4"	G1"	17,1	
KT50216	100,30	240	1800	G1 1/4"	G1"	17,4	
KT50217	110,10	230	1800	G1 1/4"	G1"	17,7	
KT50218	125,20	220	1800	G1 1/4"	G1"	18,1	

35 SERIES ISO BI-DIRECTIONAL GEAR PUMP							
Product Number Ürün Numarası	Displacement İletim Hacmi (cm /rev at 1000 rpm)	Max. Pressure Maks.Basınç (bar)	Max.Speed Maks. Hız	Inlet Giriş	Outlet Çıkış	Weight Ağırlık (Kg.)	
KT50219	60,10	260	1800	G1"	G1"	17,1	
KT50220	73,10	255	1800	G1 1/4"	G1 1/4"	17,5	
KT50221	90,05	250	1800	G1 1/4"	G1 1/4"	18,1	
KT50222	100,30	240	1800	G1 1/4"	G1 1/4"	18,4	
KT50223	110,10	230	1800	G1 1/4"	G1 1/4"	18,7	
KT50224	125,20	220	1800	G1 1/4"	G1 1/4"	19,1	

35 SERIES UNI BI-DIRECTIONAL GEAR PUMP							
Product Number Ürün Numarası	Displacement İletim Hacmi (cm /rev at 1000 rpm)	Max. Pressure Maks.Basınç (bar)	Max.Speed Maks. Hız	Inlet Giriş	Outlet Çıkış	Weight Ağırlık (Kg.)	
KT50225	60,10	260	1800	G1"	G1"	16,1	
KT50226	73,10	255	1800	G1 1/4"	G1 1/4"	16,5	
KT50227	90,05	250	1800	G1 1/4"	G1 1/4"	17,1	
KT50228	100,30	240	1800	G1 1/4"	G1 1/4"	17,4	
KT50229	110,10	230	1800	G1 1/4"	G1 1/4"	17,7	
KT50230	125,20	220	1800	G1 1/4"	G1 1/4"	18,1	









Model / Details



Description



Replaces Ref. No:

KT No.

 	40 SERIES ISO LEFT AND RIGHT GEAR PUMP						
	Product Number Ürün Numarası	Displacement İletim Hacmi (cm /rev at 1000 rpm)	Max. Pressure Maks.Basınç (bar)	Max.Speed Maks. Hız	Inlet Giriş	Outlet Çıkış	Weight Ağırlık (Kg.)
	KT50542	63,10	285	1800	G1"	G 3/4"	19,2
	KT50543	73,05	280	1800	G1 1/4"	G1"	19,5
	KT50544	87,30	270	1800	G1 1/4"	G1"	20,2
	KT50545	100,10	265	1800	G1 1/4"	G1"	21,1
	KT50546	109,20	260	1800	G1 1/4"	G1"	22,3
	KT50547	133,60	240	1500	G1 1/2"	G1"	23,2
	KT50548	151,80	210	1500	G1 1/2"	G1"	24,1

 	40 SERIES UNI LEFT AND RIGHT GEAR PUMP						
	Product Number Ürün Numarası	Displacement İletim Hacmi (cm /rev at 1000 rpm)	Max. Pressure Maks.Basınç (bar)	Max.Speed Maks. Hız	Inlet Giriş	Outlet Çıkış	Weight Ağırlık (Kg.)
	KT50549	63,10	285	1800	G1"	G 3/4"	18,2
	KT50550	73,05	280	1800	G1 1/4"	G1"	18,5
	KT50551	87,30	270	1800	G1 1/4"	G1"	19,2
	KT50552	100,10	265	1800	G1 1/4"	G1"	20,1
	KT50553	109,20	260	1800	G1 1/4"	G1"	21,3
	KT50554	133,60	240	1500	G1 1/2"	G1"	22,2
	KT50555	151,80	210	1500	G1 1/2"	G1"	23,1

 	40 SERIES ISO ASAE LEFT AND RIGHT GEAR PUMP						
	Product Number Ürün Numarası	Displacement İletim Hacmi (cm /rev at 1000 rpm)	Max. Pressure Maks.Basınç (bar)	Max.Speed Maks. Hız	Inlet Giriş	Outlet Çıkış	Weight Ağırlık (Kg.)
	KT50556	63,10	285	1800	G1"	G 3/4"	19,2
	KT50557	73,05	280	1800	G1 1/4"	G1"	19,5
	KT50558	87,30	270	1800	G1 1/4"	G1"	20,2
	KT50559	100,10	265	1800	G1 1/4"	G1"	21,1
	KT50560	109,20	260	1800	G1 1/4"	G1"	22,3
	KT50561	133,60	240	1500	G1 1/2"	G1"	23,2
	KT50562	151,80	210	1500	G1 1/2"	G1"	24,1

 	40 SERIES ISO TANDEM LEFT AND RIGHT GEAR PUMP						
	Product Number Ürün Numarası	Displacement İletim Hacmi (cm /rev at 1000 rpm)	Max. Pressure Maks.Basınç (bar)	Max.Speed Maks. Hız	Inlet Giriş	Outlet Çıkış	Weight Ağırlık (Kg.)
	KT50563	63,10	285	1800	G1"	G 3/4"	20,2
	KT50564	73,05	280	1800	G1 1/4"	G1"	20,5
	KT50565	87,30	270	1800	G1 1/4"	G1"	21,2
	KT50566	100,10	265	1800	G1 1/4"	G1"	22,1
	KT50567	109,20	260	1800	G1 1/4"	G1"	23,3
	KT50568	133,60	240	1500	G1 1/2"	G1"	24,2
	KT50569	151,80	210	1500	G1 1/2"	G1"	25,1



KT No.

Replaces Ref. No:

Description

Model / Details



40 SERIES UNI TANDEM LEFT AND RIGHT GEAR PUMP

Product Number Ürün Numarası	Displacement İletim Hacmi (cm /rev at 1000 rpm)	Max. Pressure Maks.Basınç (bar)	Max.Speed Maks. Hız	Inlet Giriş	Outlet Çıkış	Weight Ağırlık (Kg.)
KT50231	63,10	285	1800	G1"	G 3/4"	19,2
KT50232	73,05	280	1800	G1 1/4"	G1"	19,5
KT50233	87,30	270	1800	G1 1/4"	G1"	20,2
KT50234	100,10	265	1800	G1 1/4"	G1"	21,1
KT50235	109,20	260	1800	G1 1/4"	G1"	22,3
KT50236	133,60	240	1500	G1 1/2"	G1"	23,2
KT50237	151,80	210	1500	G1 1/2"	G1"	24,1



40 SERIES ISO ASAE TANDEM LEFT AND RIGHT GEAR PUMP

Product Number Ürün Numarası	Displacement İletim Hacmi (cm /rev at 1000 rpm)	Max. Pressure Maks.Basınç (bar)	Max.Speed Maks. Hız	Inlet Giriş	Outlet Çıkış	Weight Ağırlık (Kg.)
KT50238	63,10	285	1800	G1"	G 3/4"	20,2
KT50239	73,05	280	1800	G1 1/4"	G1"	20,5
KT50240	87,30	270	1800	G1 1/4"	G1"	21,2
KT50241	100,10	265	1800	G1 1/4"	G1"	22,1
KT50242	109,20	260	1800	G1 1/4"	G1"	23,3
KT50243	133,60	240	1500	G1 1/2"	G1"	24,2
KT50244	151,80	210	1500	G1 1/2"	G1"	25,1



PISTON PUMP SAEB BI-DIRECTIONAL

Product Number Ürün Numarası	Displacement İletim Hacmi (cm /rev at 1000 rpm)	Max. Pressure Maks.Basınç (bar)	Max.Speed Maks. Hız	Inlet Giriş	Outlet Çıkış	Weight Ağırlık (Kg.)
KT50245	20,10	350	1800	G1 1/4"	G1"	14,1
KT50246	26,05	350	1800	G1 1/4"	G1"	14,1
KT50247	34,30	350	1800	G1 1/4"	G1"	14,1
KT50248	42,10	350	1800	G1 1/4"	G1"	14,1
KT50249	46,20	350	1800	G1 1/4"	G1"	14,1
KT50250	52,60	350	1800	G1 1/4"	G1"	14,1
KT50251	55,80	300	1500	G1 1/4"	G1"	14,1
KT50252	60,80	300	1500	G1 1/4"	G1"	14,1





PISTON PUMP ISOTWIN BI-DIRECTIONAL

Product Number Ürün Numarası	Displacement İletim Hacmi (cm /rev at 1000 rpm)	Max. Pressure Maks.Basınç (bar)	Max.Speed Maks. Hız	Inlet Giriş	Outlet Çıkış	Weight Ağırlık (Kg.)
KT50253	20,10	350	1800	G1 1/4"	G1"	14,1
KT50254	26,05	350	1800	G1 1/4"	G1"	14,1
KT50255	34,30	350	1800	G1 1/4"	G1"	14,1
KT50256	42,10	350	1800	G1 1/4"	G1"	14,1
KT50257	46,20	350	1800	G1 1/4"	G1"	14,1
KT50258	52,60	350	1800	G1 1/4"	G1"	14,1
KT50259	55,80	300	1500	G1 1/4"	G1"	14,1
KT50260	60,80	300	1500	G1 1/4"	G1"	14,1





 Product Number Ürün Numarası	Displacement İletim Hacmi (cm /rev at 1000 rpm)	Max. Pressure Maks.Basınç (bar)	Max.Speed Maks. Hız	Inlet Giriş	Outlet Çıkış	Weight Ağırlık (Kg.)	PISTON PUMP ISO BI-DIRECTIONAL						
KT50570	20,10	350	1800	G1 1/4"	G1"	14,1							
KT50571	26,05	350	1800	G1 1/4"	G1"	14,1							
KT50572	34,30	350	1800	G1 1/4"	G1"	14,1							
KT50573	42,10	350	1800	G1 1/4"	G1"	14,1							
KT50574	46,20	350	1800	G1 1/4"	G1"	14,1							
KT50575	52,60	350	1800	G1" 1/4	G1"	14,1							
KT50576	55,80	300	1500	G1" 1/4	G1"	14,1							
KT50577	60,80	300	1500	G1" 1/4	G1"	14,1							

 Product Number Ürün Numarası	Displacement İletim Hacmi (cm /rev at 1000 rpm)	Max. Pressure Maks.Basınç (bar)	Max.Speed Maks. Hız	Inlet Giriş	Outlet Çıkış	Weight Ağırlık (Kg.)	PISTON PUMP UNI BI-DIRECTIONAL						
KT50578	20,10	350	1800	G1 1/4"	G1"	14,1							
KT50579	26,05	350	1800	G1 1/4"	G1"	14,1							
KT50580	34,30	350	1800	G1 1/4"	G1"	14,1							
KT50581	42,10	350	1800	G1 1/4"	G1"	14,1							
KT50582	46,20	350	1800	G1 1/4"	G1"	14,1							
KT50583	52,60	350	1800	G1 1/4"	G1"	14,1							
KT50584	55,80	300	1500	G1 1/4"	G1"	14,1							
KT50585	60,80	300	1500	G1 1/4"	G1"	14,1							

 Product Number Ürün Numarası	Displacement İletim Hacmi (cm /rev at 1000 rpm)	Max. Pressure Maks.Basınç (bar)	Max.Speed Maks. Hız	Inlet Giriş	Outlet Çıkış	Weight Ağırlık (Kg.)	PISTON PUMP ISO BI-DIRECTIONAL						
KT50586	62,10	350	1800	G1 1/2"	G1"	14,1							
KT50587	70,05	350	1800	G1 1/2"	G1"	14,1							
KT50588	80,30	350	1800	G1 1/2"	G1"	14,1							
KT50589	90,10	350	1800	G1 1/2"	G1"	14,1							
KT50590	100,20	350	1800	G1 1/2"	G1"	14,1							
KT50591	110,60	350	1800	G1 1/2"	G1"	14,1							

 Product Number Ürün Numarası	Displacement İletim Hacmi (cm /rev at 1000 rpm)	Max. Pressure Maks.Basınç (bar)	Max.Speed Maks. Hız	Inlet Giriş	Outlet Çıkış	Weight Ağırlık (Kg.)	BENT AXIS PISTON PUMP ISO BI-DIRECTIONAL						
KT50592	22,10	350	2900	G1 3/4"	G1 1/2"	14,1							
KT50593	33,05	350	2900	G1 3/4"	G1 1/2"	14,1							
KT50594	45,30	350	2250	G1"	G1 3/4"	14,1							
KT50595	56,10	350	2250	G1"	G1 3/4"	14,1							
KT50596	63,20	350	2250	G1"	G1 3/4"	14,1							
KT50597	80,60	350	2150	G1 1/4"	G1"	14,1							
KT50598	107,60	350	1800	G1 1/4"	G1"	14,1							
KT50599	125,60	300	1800	G1 1/4"	G1"	14,1							











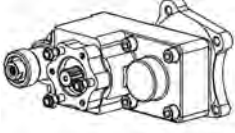

KT No.

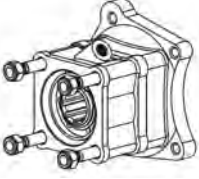
Replaces Ref. No:

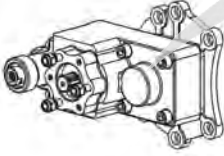



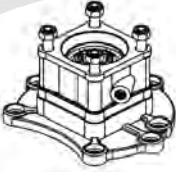



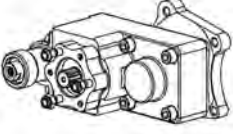

Description

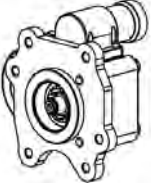
Model / Details

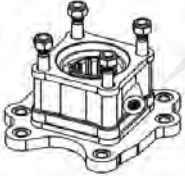
MERCEDES P.T.O.

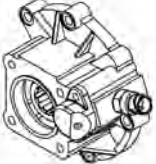
 	Ana Şanzıman:G3/32,36,40,45,50,55,60,61 (600 rpm,SOL)
	Product Number Ürün Numarası Araçlar: 315-352-362-383-609-710-712-809-812-813-814-817-913-1017-1113-1114-1213-1216-1318-1618 KT50261 MERCEDES 352-2 UNI 50120311P0
 	Ana Şanzıman:G3/32,36,40,45,50,55,60,61 (550 rpm,SAĞ)
	Product Number Ürün Numarası Araçlar: Araçlar: 315-352-362-383-609-710-712-809-812-813-814-817-913-1017-1113-1114-1213-1216-1318-1618 KT50262 MERCEDES 352-1 ISO 50121322P0
 	Ana Şanzıman: G 60,85 (650 rpm,SOL)
	Product Number Ürün Numarası -Araçlar: 614-814-815-817-818-823-925-1017-1215-1217-1223-1225-1317- 1323-1328-1517-1523-1618-1623-1823 ATEGO KT50263 MERCEDES ATEGO 7 DELİKLİ UNI AKTARMALI 50122311P0
 	Ana Şanzıman: G 60,85 (650 rpm,SOL)
	Product Number Ürün Numarası Araçlar: 614-814-815-817-818-823-925-1017-1215-1217-1223-1225-1317- 1323-1328-1517-1523-1618-1623-1823 ATEGO KT50264 MERCEDES ATEGO 7 DELİKLİ ISO AKTARMALI 50122321P0
 	Ana Şanzıman: G 60,85 (560 rpm,SAĞ)
	Product Number Ürün Numarası Araçlar: 614-814-815-817-818-823-925-1017-1215-1217-1223-1225-1317- 1323-1328-1517-1523-1618-1623-1823 ATEGO KT50265 MERCEDES ATEGO 7 DELİKLİ ISO TEK DİŞLİ 50122322P0

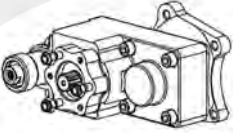

Model / Details	Description	Replaces Ref. No:	KT No.
 	Ana Şanzıman: G 56 (575 rpm,SOL) Product Number Ürün Numarası Araçlar: 815(4X2)1215-1216-1217 (2006) ATEGO KT50600 Seçeceğiniz Pompanın Dönüş yönü,Pto Dönüş Yönü ile Ters Olmalıdır. MERCEDES ATEGO 6 DELİKLİ UNI AKTARMALI 50123311P0 Millî (şaftlı) veya freze (25x6) çıkışlı. Pistonlu pompaya akuple (4 delikli bağlantı iso) Dişli pompaya akuple 6x6 kaplinli (3 delikli bağlantı uni) Kaplinli (flanşlı bağlantı)		
	 	Ana Şanzıman: G 56 (575 rpm,SOL) Product Number Ürün Numarası Araçlar: 815(4X2)1215-1216-1217 (2006) ATEGO KT50601 Seçeceğiniz Pompanın Dönüş yönü,Pto Dönüş Yönü ile Ters Olmalıdır. MERCEDES ATEGO 6 DELİKLİ ISO AKTARMALI 50123321P0 Millî (şaftlı) veya freze (25x6) çıkışlı. Pistonlu pompaya akuple (4 delikli bağlantı iso) Dişli pompaya akuple 6x6 kaplinli (3 delikli bağlantı uni) Kaplinli (flanşlı bağlantı)	
 	Ana Şanzıman: G 56 (500 rpm,SAĞ) Product Number Ürün Numarası Araçlar: 815(4X2)1215-1216-1217 (2006) ATEGO KT50602 Seçeceğiniz Pompanın Dönüş yönü,Pto Dönüş Yönü ile Ters Olmalıdır. MERCEDES ATEGO 6 DELİKLİ ISO TEK DİŞLİ 50123322P0 Millî (şaftlı) veya freze (25x6) çıkışlı. Pistonlu pompaya akuple (4 delikli bağlantı iso) Dişli pompaya akuple 6x6 kaplinli (3 delikli bağlantı uni) Kaplinli (flanşlı bağlantı)		
	 	Ana Şanzıman: G 60,85 (560 rpm,SAĞ) Product Number Ürün Numarası Araçlar: 614-814-815-817-818-823-925-1017-1215-1217-1223-1225-1317- 1323-1328-1517-1523-1618-1623-1823 ATEGO KT50603 Seçeceğiniz Pompanın Dönüş yönü,Pto Dönüş Yönü ile Ters Olmalıdır. MERCEDES ATEGO 7 DELİKLİ ISO TEK DİŞLİ ALUMINYUM 50132322P1 Millî (şaftlı) veya freze (25x6) çıkışlı. Pistonlu pompaya akuple (4 delikli bağlantı iso) Dişli pompaya akuple 6x6 kaplinli (3 delikli bağlantı uni) Kaplinli (flanşlı bağlantı)	
 		Ana Şanzıman: G100 (675 rpm,SOL) Product Number Ürün Numarası Araçlar: 1528-1823-1828-1924-2523-2528-2623-2628-2832-3224-3228 AXOR 1223-1323-1328-1523-1828-2528-2628 ATEGO KT50604 Seçeceğiniz Pompanın Dönüş yönü,Pto Dönüş Yönü ile Ters Olmalıdır. MERCEDES G100 KUYRUK UNI 50124311P0 Millî (şaftlı) veya freze (25x6) çıkışlı. Pistonlu pompaya akuple (4 delikli bağlantı iso) Dişli pompaya akuple 6x6 kaplinli (3 delikli bağlantı uni) Kaplinli (flanşlı bağlantı)	











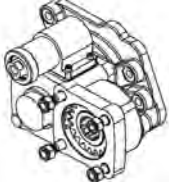

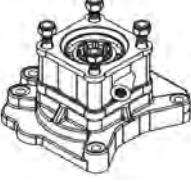
KT No.

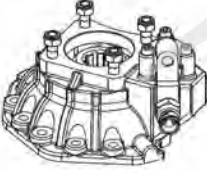

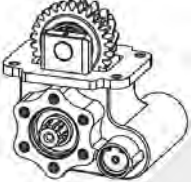
Replaces Ref. No:

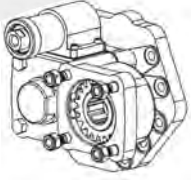

Description

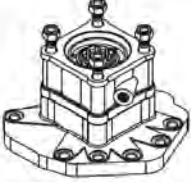

Model / Details

KT No.	Replaces Ref. No:	Description	Model / Details
 	Ana Şanzıman: G100 (675 rpm,SOL)		
	Product Number Ürün Numarası KT50266 MERCEDES G100 KUYRUK ISO AKTARMALI 50124321P0	Araçlar: 1528-1823-1828-1924-2523-2528-2623-2628-2832-3224-3228 AXOR 1223-1323-1328-1523-1828-2528-2628 ATEGO	
 	Ana Şanzıman: G100 (500 rpm,SAĞ)		
	Product Number Ürün Numarası KT50267 MERCEDES G100-1 ISO TEK DİŞLİ 50124322P0	Araçlar: 1528-1823-1828-1924-2523-2528-2623-2628-2832-3224-3228 AXOR -1223-1323-1328-1523-1828-2528-2628 ATEGO	
 	Ana Şanzıman: G125,135,155,180,200,210,221,240,255,260 (500 rpm,SAĞ)		
	Product Number Ürün Numarası KT50268 MERCEDES G155-1 ALÜMİNYUM 50125322P1	Araçlar: 1729-1735-1827-1831-1834-1835-1838-1840-1844-1848-1850-1857-1929-1934-1935-1938-1953-2031-2038-2040-2044-2050-2429-2435-2527-2531-2534-2544-2550-2629-2631-2635-2638-2643-2644-2648-2650-3031-3229-3234-3235-3331-3335-3336-3340-3348-3534-3535-3538-3548-3553-3557-4148-ACTROS MERCEDES	
 	Ana Şanzıman: İRAN		
	Product Number Ürün Numarası KT50269 MERCEDES 608-808 50131512P0	Araçlar: 608-808	
 	Ana Şanzıman: G125,135,155,180,200,210,221,240,255,260 (675 rpm,SOL)		
	Product Number Ürün Numarası KT50270 MERCEDES G155-2 50126321P0	Araçlar: 1729-1735-1827-1831-1834-1835-1838-1840-1844-1848-1850-1857-1929-1934-1935-1938-1953-2031-2038-2040-2044-2050-2429-2435-2527-2531-2534-2544-2550-2629-2631-2635-2638-2643-2644-2648-2650-3031-3229-3234-3235-3331-3335-3336-3340-3348-3534-3535-3538-3548-3553-3557-4148-ACTROS MERCEDES	

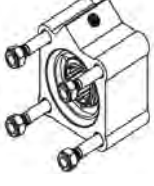

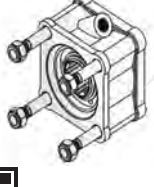

Ana Şanzıman: G125,135,155,180,200,210,221,240,255,260 (500 rpm,SAĞ)	
 	<p>Product Number Ürün Numarası Araçlar: 1729-1735-1827-1831-1834-1835-1838-1840-1844-1848-1850-1857-1929-1934-1935-1938-1953-2031-2038-2040-2044-2050-2429-2435-2527-2531-2534-2544-2550-2629-2631-2635-2638-2643-2644-2648-2650-3031-3229-3234-3235-3331-3335-3336-3340-3348-3534-3535-3538-3548-3553-3557- 4148-ACTROS MERCEDES</p> <p>KT50605 Seçeceğiniz Pompanın Dönüş yönü,Pto Dönüş Yönü ile Ters Olmalıdır.</p> <p>MERCEDES G155-1 50126322P0 Millî (şaftlı) veya freze (25x6) çıkışlı. Pistonlu pompaya akuple (4 delikli bağlantı iso) Dişli pompaya akuple 6x6 kaplinli (3 delikli bağlantı uni) Kaplinli (flanşlı bağlantı)</p>

Ana Şanzıman: G125,135,155,180,200,210,221,240,255,260 (500 rpm,SAĞ)	
 	<p>Product Number Ürün Numarası Araçlar: 1729-1735-1827-1831-1834-1835-1838-1840-1844-1848-1850-1857-1929-1934-1935-1938-1953-2031-2038-2040-2044-2050-2429-2435-2527-2531-2534-2544-2550-2629-2631-2635-2638-2643-2644-2648-2650-3031-3229-3234-3235-3331-3335-3336-3340-3348-3534-3535-3538-3548-3553-3557- 4148-ACTROS MERCEDES</p> <p>KT50606 Seçeceğiniz Pompanın Dönüş yönü,Pto Dönüş Yönü ile Ters Olmalıdır.</p> <p>MERCEDES G155-1 ALUMİNYUM GÖVDE 50127322P0 Millî (şaftlı) veya freze (25x6) çıkışlı Pistonlu pompaya akuple (4 delikli bağlantı iso) Dişli pompaya akuple 6x6 kaplinli (3 delikli bağlantı uni) Kaplinli (flanşlı bağlantı)</p>

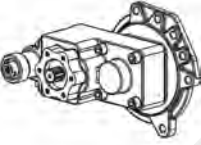
Ana Şanzıman: G125,135,155,180,200,210,221,240,255,260 (500 rpm,SAĞ)	
 	<p>Product Number Ürün Numarası Araçlar: 1729-1735-1827-1831-1834-1835-1838-1840-1844-1848-1850-1857-1929-1934-1935-1938-1953-2031-2038-2040-2044-2050-2429-2435-2527-2531-2534-2544-2550-2629-2631-2635-2638-2643-2644-2648-2650-3031-3229-3234-3235-3331-3335-3336-3340-3348-3534-3535-3538-3548-3553-3557- 4148-ACTROS MERCEDES</p> <p>KT50607 Seçeceğiniz Pompanın Dönüş yönü,Pto Dönüş Yönü ile Ters Olmalıdır.</p> <p>MERCEDES G155-1 ISO PLATESİZ 50128322P0 Millî (şaftlı) veya freze (25x6) çıkışlı. Pistonlu pompaya akuple (4 delikli bağlantı iso) Dişli pompaya akuple 6x6 kaplinli (3 delikli bağlantı uni) Kaplinli (flanşlı bağlantı)</p>

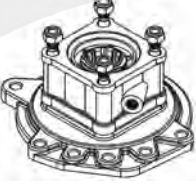
Ana Şanzıman:G4-GV / 4 65,90,95,110,125,135,155,180 (600 rpm,SAĞ)	
 	<p>Product Number Ürün Numarası Araçlar:1222-1224-1417-1419-1424-1617-1619-1620-1628-1722-1733-1817-1820-1821-1824-1827-1831-1922-1929-1935-1948-2222-2224-2232-2426-2517-2521-2524-2527-2622-2629-2635-3027 MERCEDES BENZ</p> <p>KT50608 Seçeceğiniz Pompanın Dönüş yönü,Pto Dönüş Yönü ile Ters Olmalıdır.</p> <p>MERCEDES G4 AKTARMALI 50129311P0 Millî (şaftlı) veya freze (25x6) çıkışlı. Pistonlu pompaya akuple (4 delikli bağlantı iso) Dişli pompaya akuple 6x6 kaplinli (3 delikli bağlantı uni) Kaplinli (flanşlı bağlantı)</p>

Ana Şanzıman:G4-GV / 4 65,90,95,110,125,135,155,180 (500 rpm,SAĞ)	
 	<p>Product Number Ürün Numarası Araçlar:1222-1224-1417-1419-1424-1617-1619-1620-1628-1722-1733-1817-1820-1821-1824-1827-1831-1922-1929-1935-1948-2222-2224-2232-2426-2517-2521-2524-2527-2622-2629-2635-3027 MERCEDES BENZ</p> <p>KT50609 Seçeceğiniz Pompanın Dönüş yönü,Pto Dönüş Yönü ile Ters Olmalıdır.</p> <p>MERCEDES G4 TEK DİŞLİ 50129322P0 Millî (şaftlı) veya freze (25x6) çıkışlı. Pistonlu pompaya akuple (4 delikli bağlantı iso) Dişli pompaya akuple 6x6 kaplinli (3 delikli bağlantı uni) Kaplinli (flanşlı bağlantı)</p>





KT No.



Replaces Ref. No:

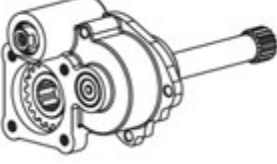

Description

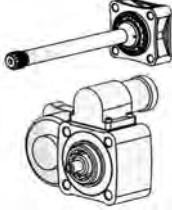

Model / Details



 	Ana Şanzıman: G3 / 65-90 (1000 rpm,SOL)	
	Product Number Ürün Numarası	Araçlar: 1217-1219-1413-1419-1422-1613-1619-1922K-2024-2067 MERCEDES-BENZ / UNIMOG BENZ
	KT50271	Seçeceğiniz Pompanın Dönüş yönü,Pto Dönüş Yönü ile Ters Olmalıdır
	MERCEDES UNIMOG G3/65-90 50130321P0	Milli (şaftlı) veya freze (25x6) çıkışlı. Pistonlu pompaya akuple (4 delikli bağlantı iso) Dişli pompaya akuple 6x6 kaplinli (3 delikli bağlantı uni) Kaplinli (flanşlı bağlantı)

ZF P.T.O.

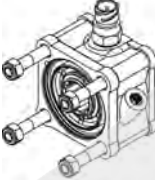



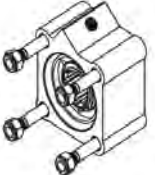





 	Ana Şanzıman: ZF AS TRONIC 16 AS 251 / 16 S 251 + PLATE 12 AS 1631	
	Product Number Ürün Numarası	Araçlar: TG-A 18.460A -19.430 MAN EUROPE 6X4 / 3300 DAF-85.330 CF DAF /14.463 MAN / IVECO 480 STRALIS /39.390 MAN TGA
	KT50272	Milli (şaftlı) veya freze (25x6) çıkışlı.
	ZF AS TRONIC 16 S 251 AKTARMALI PLATE ROTERDAR	Pistonlu pompaya akuple (4 delikli bağlantı iso) Dişli pompaya akuple 6x6 kaplinli (3 delikli bağlantı uni) Kaplinli (flanşlı bağlantı)

 	Ana Şanzıman: ZF16S251-221-151-150-130- ZF S5/AK/6 S-120-111-110-92-GP ZF S5/AK/6S	
	Product Number Ürün Numarası	Araçlar: MAN / MERCEDES / BMC PROFESYONEL /FORD CARGO / CHRYSLER HİNO / DODGE / FARGO / IVECO / DAF / DAEWOO /RENAULT
	KT50273	Seçeceğiniz Pompanın Dönüş yönü,Pto Dönüş Yönü ile Ters Olmalıdır.
	ZF1 50210322P0 KUYRUK TEK DİŞLİ	Milli (şaftlı) veya freze (25x6) çıkışlı. Pistonlu pompaya akuple (4 delikli bağlantı iso) Dişli pompaya akuple 6x6 kaplinli (3 delikli bağlantı uni) Kaplinli (flanşlı bağlantı)

 	Ana Şanzıman: ZF16S251-221-151-150-130- ZF S5/AK/6 S-120-111-110-92-GP ZF S5/AK/6S-90	
	Product Number Ürün Numarası	Araçlar: MAN / MERCEDES / BMC PROFESYONEL /FORD CARGO / CHRYSLER HİNO / DODGE / FARGO / IVECO / DAF / DAEWOO /RENAULT
	KT50274	Seçeceğiniz Pompanın Dönüş yönü,Pto Dönüş Yönü ile Ters Olmalıdır.
	ZF1 MÜŞÜRLÜ 50210322P1 KUYRUK TEK DİŞLİ	Milli (şaftlı) veya freze (25x6) çıkışlı. Pistonlu pompaya akuple (4 delikli bağlantı iso) Dişli pompaya akuple 6x6 kaplinli (3 delikli bağlantı uni) Kaplinli (flanşlı bağlantı)

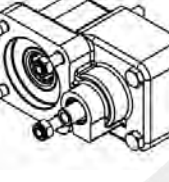
 	Ana Şanzıman: ZF16S251-221-151-150-130- ZF S5/AK/6 S-120-111-110-92	
	Product Number Ürün Numarası	Araçlar: MAN / MERCEDES / BMC PROFESYONEL /FORD CARGO / CHRYSLER HİNO / DODGE / FARGO / IVECO / DAF / DAEWOO /RENAULT
	KT50275	Seçeceğiniz Pompanın Dönüş yönü,Pto Dönüş Yönü ile Ters Olmalıdır.
	ZF1 ALUMINYUM 50213322P0 KUYRUK TEK DİŞLİ	Milli (şaftlı) veya freze (25x6) çıkışlı. Pistonlu pompaya akuple (4 delikli bağlantı iso) Dişli pompaya akuple 6x6 kaplinli (3 delikli bağlantı uni) Kaplinli (flanşlı bağlantı)

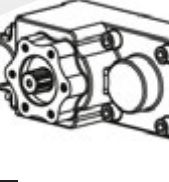

Model / Details	Description	Replaces Ref. No:	KT No.
 	<p>Ana Şanzıman: ZF16S251-221-151-150-130- ZF S5/AK/6 S-120-111-110-92</p> <p>Product Number Ürün Numarası Araçlar: MAN / MERCEDES / BMC PROFESYONEL /FORD CARGO / CHRYSLER HINO / DODGE / FARGO / IVECO / DAF / DAEWOO /RENAULT</p> <p>KT50610 Seçeceğiniz Pompanın Dönüş yönü,Pto Dönüş Yönü ile Ters Olmalıdır.</p> <p>ZF1 ALUMINYUM MÜŞÜRLÜ 50213322P1 KUYRUK TEK DİŞLİ</p> <p>Milli (şaftlı) veya freze (25x6) çıkışlı. Pistonlu pompaya akuple (4 delikli bağlantı iso) Dişli pompaya akuple 6x6 kaplinli (3 delikli bağlantı uni) Kaplinli (flanşlı bağlantı)</p>		
 	<p>Ana Şanzıman: Zf16 S251-221-151-150-130- ZF S5/AK/6S-120-111-110-92-</p> <p>Product Number Ürün Numarası -Araçlar: MAN / MERCEDES / BMC PROFESYONEL /FORD CARGO / CHRYSLER HINO / DODGE / FARGO / İVECO / DAF / DAEWOO / RENAULT</p> <p>KT50611 Seçeceğiniz Pompanın Dönüş yönü,Pto Dönüş Yönü ile Ters Olmalıdır.</p> <p>ZF2 50210321P0 KUYRUK ÇİFT DİŞLİ</p> <p>Milli (şaftlı) veya freze (25x6) çıkışlı. Pistonlu pompaya akuple (4 delikli bağlantı iso) Dişli pompaya akuple 6x6 kaplinli (3 delikli bağlantı uni) Kaplinli (flanşlı bağlantı)</p>		
 	<p>Ana Şanzıman: Zf16 S251-221-151-150-130- ZF S5/AK/6S-120-111-110-92</p> <p>Product Number Ürün Numarası Araçlar: MAN / MERCEDES / BMC PROFESYONEL /FORD CARGO / CHRYSLER HINO / DODGE / FARGO / İVECO / DAF / DAEWOO / RENAULT</p> <p>KT50612 Seçeceğiniz Pompanın Dönüş yönü,Pto Dönüş Yönü ile Ters Olmalıdır.</p> <p>ZF5 50241321P0 KUYRUK HAVA YASTIKLI HELİS ÇİFT DİŞLİ</p> <p>Milli (şaftlı) veya freze (25x6) çıkışlı. Pistonlu pompaya akuple (4 delikli bağlantı iso) Dişli pompaya akuple 6x6 kaplinli (3 delikli bağlantı uni) Kaplinli (flanşlı bağlantı)</p>		
 	<p>Ana Şanzıman: Zf16 S251-221-151-150-130- ZF S5/AK/6S-120-111-110-92</p> <p>Product Number Ürün Numarası Araçlar: MAN / MERCEDES / BMC PROFESYONEL /FORD CARGO / CHRYSLER HINO / DODGE / FARGO / İVECO / DAF / DAEWOO / RENAULT</p> <p>KT50613 Seçeceğiniz Pompanın Dönüş yönü,Pto Dönüş Yönü ile Ters Olmalıdır.</p> <p>ZF KUYRUK ÇİFT DİŞLİ HAVA YASTIKLI 50232321P0</p> <p>Milli (şaftlı) veya freze (25x6) çıkışlı. Pistonlu pompaya akuple (4 delikli bağlantı iso) Dişli pompaya akuple 6x6 kaplinli (3 delikli bağlantı uni) Kaplinli (flanşlı bağlantı)</p>		
 	<p>Ana Şanzıman:ZF ECOLITE 6 S 850 (6,72) - 6S700 (6,02) (650 rpm,SOL)</p> <p>Product Number Ürün Numarası Araçlar:8.163-10.185-L 160C-LE 12.160-12.163-12.185-LE 18.220-18.225-18.230-18.240 MAN / 518-522 PRO / DAEWOO AVIA (CEK CUM.) / 180.18-180.25</p> <p>KT50614 Seçeceğiniz Pompanın Dönüş yönü,Pto Dönüş Yönü ile Ters Olmalıdır.</p> <p>ZF 6 S 850 50219311P0 KUYRUK</p> <p>Milli (şaftlı) veya freze (25x6) çıkışlı Pistonlu pompaya akuple (4 delikli bağlantı iso) Dişli pompaya akuple 6x6 kaplinli (3 delikli bağlantı uni) Kaplinli (flanşlı bağlantı)</p>		











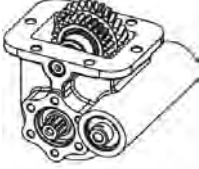

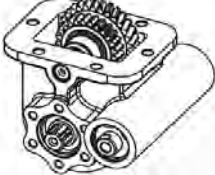
KT No.

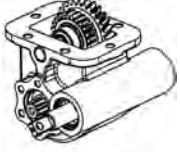

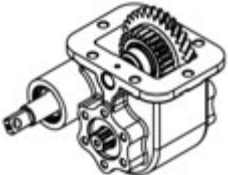







Replaces Ref. No:

Description

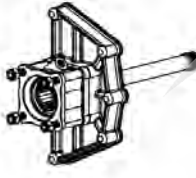
Model / Details

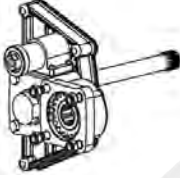
 	Ana Şanzıman:ZF ECOLITE S5-42 (5,72) (1000 rpm,SAĞ)
	Product Number Ürün Numarası Araçlar:8.150-8.153-10.153-10.163-10.185 MAN / MB 800-1215-1517-ATEGO MERCEDES-BENZ / 45LF-170 DAF 45.120-45.130-45.150-45.160-50.130 KT50276 ZF 5,72 PNÖMATİK 50220512P0 Seçeceğiniz Pompanın Dönüş yönü,Pto Dönüş Yönü ile Ters Olmalıdır. Millî (şaftlı) veya freze (25x6) çıkışlı. Pistonlu pompaya akuple (4 delikli bağlantı iso) Dişli pompaya akuple 6x6 kaplinli (3 delikli bağlantı uni) Kaplinli (flanşlı bağlantı)
 	Ana Şanzıman:ZF ECOLITE S5-42 (4,65) (1000 rpm,SAĞ)
	Product Number Ürün Numarası Araçlar:8.145-8.155-8.163 MAN KT50277 ZF 4,65 PNÖMATİK 50222512P0 Seçeceğiniz Pompanın Dönüş yönü,Pto Dönüş Yönü ile Ters Olmalıdır. Millî (şaftlı) veya freze (25x6) çıkışlı. Pistonlu pompaya akuple (4 delikli bağlantı iso) Dişli pompaya akuple 6x6 kaplinli (3 delikli bağlantı uni) Kaplinli (flanşlı bağlantı)
 	Ana Şanzıman:2000 / SCAM 4X4 for GearBox Type ZF ECOLITE 6s300 (6,73)
	Product Number Ürün Numarası Araçlar:110 dCı-130 dCI-140 dCI-150 dCI-160 Dxi RENAULT MASCOTT / IVECO 35 C 13 DAILY GAMMA KT50278 ZF 6S 300 MEKANİK 50215512M0 Seçeceğiniz Pompanın Dönüş yönü,Pto Dönüş Yönü ile Ters Olmalıdır. Millî (şaftlı) veya freze (25x6) çıkışlı. Pistonlu pompaya akuple (4 delikli bağlantı iso) Dişli pompaya akuple 6x6 kaplinli (3 delikli bağlantı uni) Kaplinli (flanşlı bağlantı)
 	Ana Şanzıman:2000 / SCAM 4X4 for GearBox Type ZF ECOLITE 6s300 (6,73)
	Product Number Ürün Numarası Araçlar:110 dCı-130 dCI-140 dCI-150 dCI-160 Dxi RENAULT MASCOTT / IVECO 35 C 13 DAILY GAMMA KT50279 ZF 6S 400 MEKANİK 50216512M0 Seçeceğiniz Pompanın Dönüş yönü,Pto Dönüş Yönü ile Ters Olmalıdır. Millî (şaftlı) veya freze (25x6) çıkışlı. Pistonlu pompaya akuple (4 delikli bağlantı iso) Dişli pompaya akuple 6x6 kaplinli (3 delikli bağlantı uni) Kaplinli (flanşlı bağlantı)
 	Ana Şanzıman: ZF 6S 380 / 6S 400 / IVECO SpA 2840.623M0 / IVECO SpA 2840.618D11
	Product Number Ürün Numarası Araçlar: IVECO 45C15 - DAILY 4X4 - 50C18 - 35C15 - 50C15 - IVECO 65C15 - 70C15 - IVECO DAILY 4X4 55S18 / NISSAN ATLEON KT50280 ZF 6S 400 MEKANİK 50216512M0 Seçeceğiniz Pompanın Dönüş yönü,Pto Dönüş Yönü ile Ters Olmalıdır. Millî (şaftlı) veya freze (25x6) çıkışlı. Pistonlu pompaya akuple (4 delikli bağlantı iso) Dişli pompaya akuple 6x6 kaplinli (3 delikli bağlantı uni) Kaplinli (flanşlı bağlantı)



 	Ana Şanzıman:ZF 6S 380 / 6S 400 / IVECO SpA 2840.623M0 / IVECO SpA 2840.618D11	
	Product Number Ürün Numarası	Araçlar:IVECO 45C15 - DAILY 4X4 - 50C18 - 35C15 - 50C15 - IVECO 65C15 - 70C15 - IVECO DAILY 4X4 55S18 / NISSAN ATLEON
 	Ana Şanzıman: ZF 6 S 500 TO	
	Product Number Ürün Numarası	Araçlar:FAW 8.140 FL,FOTON 10-16 DT,OTOKAR ATLAS E6
 	Şanzıman:TRAXON 12 TX 2620 TD	
	Product Number Ürün Numarası	Araçlar:TRAXON 12 TX 2620 TD
 	Ana Şanzıman:TRAXON 12 TX 2620 TD	
	Product Number Ürün Numarası	Araçlar:TRAXON 12 TX 2620 TD
 	Ana Şanzıman:ZF ECOMID 9 S 75 (13,16/9,56)(B:252) (450 rpm,SAĞ)	
	Product Number Ürün Numarası	Araçlar:2521-2524-3224 MERCEDES / 617-620-622-625-822 BMC PRO / 1824-2524-2524D-2534 FORD CARGO / 19.260-26.260
	KT50615	Seçeceğiniz Pompanın Dönüş yönü,Pto Dönüş Yönü ile Ters Olmalıdır.
	ZF 6S 400 ÇİFT TESİRLİ VAKUMLU 50216512M0	Milli (şaftlı) veya freze (25x6) çıkışlı Pistonlu pompaya akuple (4 delikli bağlantı iso) Dişli pompaya akuple 6x6 kaplinli (3 delikli bağlantı uni) Kaplinli (flanşlı bağlantı)
	KT50616	Seçeceğiniz Pompanın Dönüş yönü,Pto Dönüş Yönü ile Ters Olmalıdır.
	ZF 6 S 500 PK 50218512P0	Milli (şaftlı) veya freze (25x6) çıkışlı. Pistonlu pompaya akuple (4 delikli bağlantı iso) Dişli pompaya akuple 6x6 kaplinli (3 delikli bağlantı uni) Kaplinli (flanşlı bağlantı)
	KT50617	Seçeceğiniz Pompanın Dönüş yönü,Pto Dönüş Yönü ile Ters Olmalıdır
	ZF TRAXON TEK DİŞLİ 50240322P0	Milli (şaftlı) veya freze (25x6) çıkışlı. Pistonlu pompaya akuple (4 delikli bağlantı iso) Dişli pompaya akuple 6x6 kaplinli (3 delikli bağlantı uni) Kaplinli (flanşlı bağlantı)
	KT50618	Seçeceğiniz Pompanın Dönüş yönü,Pto Dönüş Yönü ile Ters Olmalıdır.
	ZF TRAXON AKTARMALI 50240321P0	Milli (şaftlı) veya freze (25x6) çıkışlı. Pistonlu pompaya akuple (4 delikli bağlantı iso) Dişli pompaya akuple 6x6 kaplinli (3 delikli bağlantı uni) Kaplinli (flanşlı bağlantı)
	KT50619	Seçeceğiniz Pompanın Dönüş yönü,Pto Dönüş Yönü ile Ters Olmalıdır.
	ZF ECOMID 9 S 75 TEK DİŞLİ	Milli (şaftlı) veya freze (25x6) çıkışlı. Pistonlu pompaya akuple (4 delikli bağlantı iso) Dişli pompaya akuple 6x6 kaplinli (3 delikli bağlantı uni) Kaplinli (flanşlı bağlantı)











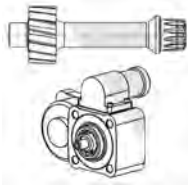

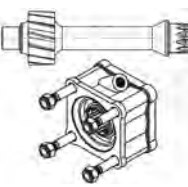
KT No.

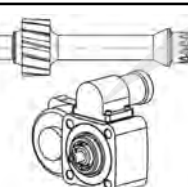
Replaces Ref. No:

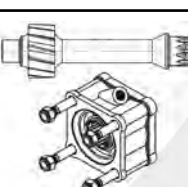
Description

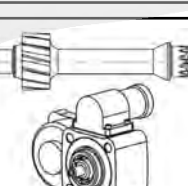
Model / Details

 	<table border="1"> <thead> <tr> <th colspan="2">Ana Şanzıman: ZF ECOMID 9 S 75 (13,16/9,56)(B:252)</th> </tr> </thead> <tbody> <tr> <td>Product Number Ürün Numarası</td> <td>-Araçlar:2521-2524-3224 MERCEDES / 617-620-622-625-822 BMC PRO / 1824-2524-2524D-2534 FORD CARGO / 19.260-26.260-26.265-</td> </tr> <tr> <td>KT50281</td> <td>Milli (şaftlı) veya freze (25x6) çıkışlı.</td> </tr> <tr> <td>ZF ECOMID 9 S 75 AKTARMALI</td> <td>Pistonlu pompaya akuple (4 delikli bağlantı) Dişli pompaya akuple splaynli (3 delikli bağlantı) -Kaplinli (flanşlı bağlantı) -</td> </tr> </tbody> </table>	Ana Şanzıman: ZF ECOMID 9 S 75 (13,16/9,56)(B:252)		Product Number Ürün Numarası	-Araçlar:2521-2524-3224 MERCEDES / 617-620-622-625-822 BMC PRO / 1824-2524-2524D-2534 FORD CARGO / 19.260-26.260-26.265-	KT50281	Milli (şaftlı) veya freze (25x6) çıkışlı.	ZF ECOMID 9 S 75 AKTARMALI	Pistonlu pompaya akuple (4 delikli bağlantı) Dişli pompaya akuple splaynli (3 delikli bağlantı) -Kaplinli (flanşlı bağlantı) -
Ana Şanzıman: ZF ECOMID 9 S 75 (13,16/9,56)(B:252)									
Product Number Ürün Numarası	-Araçlar:2521-2524-3224 MERCEDES / 617-620-622-625-822 BMC PRO / 1824-2524-2524D-2534 FORD CARGO / 19.260-26.260-26.265-								
KT50281	Milli (şaftlı) veya freze (25x6) çıkışlı.								
ZF ECOMID 9 S 75 AKTARMALI	Pistonlu pompaya akuple (4 delikli bağlantı) Dişli pompaya akuple splaynli (3 delikli bağlantı) -Kaplinli (flanşlı bağlantı) -								
 	<table border="1"> <thead> <tr> <th colspan="2">Ana Şanzıman: ZF ECOMID 9 S 109 (12,91) (B:288)/ 9 S 109 (11,10)</th> </tr> </thead> <tbody> <tr> <td>Product Number Ürün Numarası</td> <td>Araçlar:32.270 MAN /827-832 BMC PRO 270-26 FATİH / 3226-3227C-3227S-2527 FORD CARGO / 1830-2530-3230C-3230S-3240-4030-</td> </tr> <tr> <td>KT50282</td> <td>Milli (şaftlı) veya freze (25x6) çıkışlı.</td> </tr> <tr> <td>ZF ECOMID 9 S 109 (12,91) TEK DİŞLİ</td> <td>Pistonlu pompaya akuple (4 delikli bağlantı iso) Dişli pompaya akuple 6x6 kaplinli (3 delikli bağlantı uni) Kaplinli (flanşlı bağlantı) -</td> </tr> </tbody> </table>	Ana Şanzıman: ZF ECOMID 9 S 109 (12,91) (B:288)/ 9 S 109 (11,10)		Product Number Ürün Numarası	Araçlar:32.270 MAN /827-832 BMC PRO 270-26 FATİH / 3226-3227C-3227S-2527 FORD CARGO / 1830-2530-3230C-3230S-3240-4030-	KT50282	Milli (şaftlı) veya freze (25x6) çıkışlı.	ZF ECOMID 9 S 109 (12,91) TEK DİŞLİ	Pistonlu pompaya akuple (4 delikli bağlantı iso) Dişli pompaya akuple 6x6 kaplinli (3 delikli bağlantı uni) Kaplinli (flanşlı bağlantı) -
Ana Şanzıman: ZF ECOMID 9 S 109 (12,91) (B:288)/ 9 S 109 (11,10)									
Product Number Ürün Numarası	Araçlar:32.270 MAN /827-832 BMC PRO 270-26 FATİH / 3226-3227C-3227S-2527 FORD CARGO / 1830-2530-3230C-3230S-3240-4030-								
KT50282	Milli (şaftlı) veya freze (25x6) çıkışlı.								
ZF ECOMID 9 S 109 (12,91) TEK DİŞLİ	Pistonlu pompaya akuple (4 delikli bağlantı iso) Dişli pompaya akuple 6x6 kaplinli (3 delikli bağlantı uni) Kaplinli (flanşlı bağlantı) -								
 	<table border="1"> <thead> <tr> <th colspan="2">Ana Şanzıman: ZF ECOMID 9 S 109 (12,91) (B:288) / 9 S1310 (9,48)</th> </tr> </thead> <tbody> <tr> <td>Product Number Ürün Numarası</td> <td>Araçlar:32.270 MAN /827-832 BMC PRO 270-26 FATİH / 3226-3227C-3227S-2527 FORD CARGO / 1830-2530-3230C-3230S-3240-4030-</td> </tr> <tr> <td>KT50283</td> <td>Milli (şaftlı) veya freze (25x6) çıkışlı.</td> </tr> <tr> <td>ZF ECOMID 9 S 109 (12,91) AKTARMALI</td> <td>Pistonlu pompaya akuple (4 delikli bağlantı iso) Dişli pompaya akuple 6x6 kaplinli (3 delikli bağlantı uni) Kaplinli (flanşlı bağlantı) -</td> </tr> </tbody> </table>	Ana Şanzıman: ZF ECOMID 9 S 109 (12,91) (B:288) / 9 S1310 (9,48)		Product Number Ürün Numarası	Araçlar:32.270 MAN /827-832 BMC PRO 270-26 FATİH / 3226-3227C-3227S-2527 FORD CARGO / 1830-2530-3230C-3230S-3240-4030-	KT50283	Milli (şaftlı) veya freze (25x6) çıkışlı.	ZF ECOMID 9 S 109 (12,91) AKTARMALI	Pistonlu pompaya akuple (4 delikli bağlantı iso) Dişli pompaya akuple 6x6 kaplinli (3 delikli bağlantı uni) Kaplinli (flanşlı bağlantı) -
Ana Şanzıman: ZF ECOMID 9 S 109 (12,91) (B:288) / 9 S1310 (9,48)									
Product Number Ürün Numarası	Araçlar:32.270 MAN /827-832 BMC PRO 270-26 FATİH / 3226-3227C-3227S-2527 FORD CARGO / 1830-2530-3230C-3230S-3240-4030-								
KT50283	Milli (şaftlı) veya freze (25x6) çıkışlı.								
ZF ECOMID 9 S 109 (12,91) AKTARMALI	Pistonlu pompaya akuple (4 delikli bağlantı iso) Dişli pompaya akuple 6x6 kaplinli (3 delikli bağlantı uni) Kaplinli (flanşlı bağlantı) -								
 	<table border="1"> <thead> <tr> <th colspan="2">Ana Şanzıman: ZF ECOMID 9 S 109 (12,92) (B:288) / 8 S 109 (11,35)</th> </tr> </thead> <tbody> <tr> <td>Product Number Ürün Numarası</td> <td>Araçlar:17.192-17.232-18.220-19.270-25.270-26.230-26.270 MAN / 1827-2527-2626 FORD CARGO / 75.270-75.300 DAF / LEYLAND</td> </tr> <tr> <td>KT50284</td> <td>Milli (şaftlı) veya freze (25x6) çıkışlı.</td> </tr> <tr> <td>ZF ECOMID 9 S 109 (12,92) TEK DİŞLİ</td> <td>Pistonlu pompaya akuple (4 delikli bağlantı iso) Dişli pompaya akuple 6x6 kaplinli (3 delikli bağlantı uni) Kaplinli (flanşlı bağlantı) -</td> </tr> </tbody> </table>	Ana Şanzıman: ZF ECOMID 9 S 109 (12,92) (B:288) / 8 S 109 (11,35)		Product Number Ürün Numarası	Araçlar:17.192-17.232-18.220-19.270-25.270-26.230-26.270 MAN / 1827-2527-2626 FORD CARGO / 75.270-75.300 DAF / LEYLAND	KT50284	Milli (şaftlı) veya freze (25x6) çıkışlı.	ZF ECOMID 9 S 109 (12,92) TEK DİŞLİ	Pistonlu pompaya akuple (4 delikli bağlantı iso) Dişli pompaya akuple 6x6 kaplinli (3 delikli bağlantı uni) Kaplinli (flanşlı bağlantı) -
Ana Şanzıman: ZF ECOMID 9 S 109 (12,92) (B:288) / 8 S 109 (11,35)									
Product Number Ürün Numarası	Araçlar:17.192-17.232-18.220-19.270-25.270-26.230-26.270 MAN / 1827-2527-2626 FORD CARGO / 75.270-75.300 DAF / LEYLAND								
KT50284	Milli (şaftlı) veya freze (25x6) çıkışlı.								
ZF ECOMID 9 S 109 (12,92) TEK DİŞLİ	Pistonlu pompaya akuple (4 delikli bağlantı iso) Dişli pompaya akuple 6x6 kaplinli (3 delikli bağlantı uni) Kaplinli (flanşlı bağlantı) -								
 	<table border="1"> <thead> <tr> <th colspan="2">Ana Şanzıman: ZF ECOMID 9 S 109 (12,92) (B:288) / 8 S 109(11,35)</th> </tr> </thead> <tbody> <tr> <td>Product Number Ürün Numarası</td> <td>Araçlar:17.192-17.232-18.220-19.270-25.270-26.230-26.270 MAN / 1827-2527-2626 FORD CARGO / 75.270-75.300 DAF / LEYLAND</td> </tr> <tr> <td>KT50285</td> <td>Milli (şaftlı) veya freze (25x6) çıkışlı</td> </tr> <tr> <td>ZF ECOMID 9 S 109 (12,92) AKTARMALI</td> <td>Pistonlu pompaya akuple (4 delikli bağlantı iso) Dişli pompaya akuple 6x6 kaplinli (3 delikli bağlantı uni) Kaplinli (flanşlı bağlantı) -</td> </tr> </tbody> </table>	Ana Şanzıman: ZF ECOMID 9 S 109 (12,92) (B:288) / 8 S 109(11,35)		Product Number Ürün Numarası	Araçlar:17.192-17.232-18.220-19.270-25.270-26.230-26.270 MAN / 1827-2527-2626 FORD CARGO / 75.270-75.300 DAF / LEYLAND	KT50285	Milli (şaftlı) veya freze (25x6) çıkışlı	ZF ECOMID 9 S 109 (12,92) AKTARMALI	Pistonlu pompaya akuple (4 delikli bağlantı iso) Dişli pompaya akuple 6x6 kaplinli (3 delikli bağlantı uni) Kaplinli (flanşlı bağlantı) -
Ana Şanzıman: ZF ECOMID 9 S 109 (12,92) (B:288) / 8 S 109(11,35)									
Product Number Ürün Numarası	Araçlar:17.192-17.232-18.220-19.270-25.270-26.230-26.270 MAN / 1827-2527-2626 FORD CARGO / 75.270-75.300 DAF / LEYLAND								
KT50285	Milli (şaftlı) veya freze (25x6) çıkışlı								
ZF ECOMID 9 S 109 (12,92) AKTARMALI	Pistonlu pompaya akuple (4 delikli bağlantı iso) Dişli pompaya akuple 6x6 kaplinli (3 delikli bağlantı uni) Kaplinli (flanşlı bağlantı) -								



Model / Details	Description	Replaces Ref. No:	KT No.
-----------------	-------------	-------------------	--------

Ana Şanzıman: ZF ECOMID 16 S 109 (13,53-11,86) (B:288) / 8 S 109													
	<table><tr><td>Product Number Ürün Numarası</td><td>Araçlar:17.232-19.230-19.340-26.342 MAN / 2530-3226 FORD CARGO / RENAULT PREMIUM 320.32-370 AS19.300-26.300 32.300</td></tr><tr><td>KT50620</td><td>Milli (şaftlı) veya freze (25x6) çıkışlı.</td></tr><tr><td>ZF ECOMID 16 S 109 TEK DİŞLİ</td><td>Pistonlu pompaya akuple (4 delikli bağlantı iso)</td></tr><tr><td></td><td>Dişli pompaya akuple 6x6 kaplinli (3 delikli bağlantı uni)</td></tr><tr><td></td><td>Kaplinli (flanşlı bağlantı)</td></tr><tr><td></td><td>-</td></tr></table>	Product Number Ürün Numarası	Araçlar:17.232-19.230-19.340-26.342 MAN / 2530-3226 FORD CARGO / RENAULT PREMIUM 320.32-370 AS19.300-26.300 32.300	KT50620	Milli (şaftlı) veya freze (25x6) çıkışlı.	ZF ECOMID 16 S 109 TEK DİŞLİ	Pistonlu pompaya akuple (4 delikli bağlantı iso)		Dişli pompaya akuple 6x6 kaplinli (3 delikli bağlantı uni)		Kaplinli (flanşlı bağlantı)		-
Product Number Ürün Numarası	Araçlar:17.232-19.230-19.340-26.342 MAN / 2530-3226 FORD CARGO / RENAULT PREMIUM 320.32-370 AS19.300-26.300 32.300												
KT50620	Milli (şaftlı) veya freze (25x6) çıkışlı.												
ZF ECOMID 16 S 109 TEK DİŞLİ	Pistonlu pompaya akuple (4 delikli bağlantı iso)												
	Dişli pompaya akuple 6x6 kaplinli (3 delikli bağlantı uni)												
	Kaplinli (flanşlı bağlantı)												
	-												

Ana Şanzıman: ZF ECOMID 16 S 109 (13,53-11,86) (B:288) / 8 S 109													
	<table><tr><td>Product Number Ürün Numarası</td><td>Araçlar:17.232-19.230-19.340-26.342 MAN / 2530-3226 FORD CARGO / RENAULT PREMIUM 320.32-370 AS19.300-26.300 32.300</td></tr><tr><td>KT50621</td><td>Milli (şaftlı) veya freze (25x6) çıkışlı.</td></tr><tr><td>ZF ECOMID 16 S 109 AKTARMALI</td><td>Pistonlu pompaya akuple (4 delikli bağlantı iso)</td></tr><tr><td></td><td>Dişli pompaya akuple 6x6 kaplinli (3 delikli bağlantı uni)</td></tr><tr><td></td><td>Kaplinli (flanşlı bağlantı)</td></tr><tr><td></td><td>-</td></tr></table>	Product Number Ürün Numarası	Araçlar:17.232-19.230-19.340-26.342 MAN / 2530-3226 FORD CARGO / RENAULT PREMIUM 320.32-370 AS19.300-26.300 32.300	KT50621	Milli (şaftlı) veya freze (25x6) çıkışlı.	ZF ECOMID 16 S 109 AKTARMALI	Pistonlu pompaya akuple (4 delikli bağlantı iso)		Dişli pompaya akuple 6x6 kaplinli (3 delikli bağlantı uni)		Kaplinli (flanşlı bağlantı)		-
Product Number Ürün Numarası	Araçlar:17.232-19.230-19.340-26.342 MAN / 2530-3226 FORD CARGO / RENAULT PREMIUM 320.32-370 AS19.300-26.300 32.300												
KT50621	Milli (şaftlı) veya freze (25x6) çıkışlı.												
ZF ECOMID 16 S 109 AKTARMALI	Pistonlu pompaya akuple (4 delikli bağlantı iso)												
	Dişli pompaya akuple 6x6 kaplinli (3 delikli bağlantı uni)												
	Kaplinli (flanşlı bağlantı)												
	-												

Ana Şanzıman: ZF ECOSPLIT 16 S 151-181-221-251 (13,80-13,85-16)													
	<table><tr><td>Product Number Ürün Numarası</td><td>Araçlar:17.322-19.422-423-426 / 26.310-372-373-422 / 32.310-33.372-33.423-40.423-40.463-41.423 MAN / STRALIS 430 / FE 420A</td></tr><tr><td>KT50622</td><td>Milli (şaftlı) veya freze (25x6) çıkışlı</td></tr><tr><td>ZF ECOSPLIT 16 S 151 TEK DİŞLİ</td><td>Pistonlu pompaya akuple (4 delikli bağlantı iso)</td></tr><tr><td></td><td>Dişli pompaya akuple 6x6 kaplinli (3 delikli bağlantı uni)</td></tr><tr><td></td><td>Kaplinli (flanşlı bağlantı)</td></tr><tr><td></td><td>-</td></tr></table>	Product Number Ürün Numarası	Araçlar:17.322-19.422-423-426 / 26.310-372-373-422 / 32.310-33.372-33.423-40.423-40.463-41.423 MAN / STRALIS 430 / FE 420A	KT50622	Milli (şaftlı) veya freze (25x6) çıkışlı	ZF ECOSPLIT 16 S 151 TEK DİŞLİ	Pistonlu pompaya akuple (4 delikli bağlantı iso)		Dişli pompaya akuple 6x6 kaplinli (3 delikli bağlantı uni)		Kaplinli (flanşlı bağlantı)		-
Product Number Ürün Numarası	Araçlar:17.322-19.422-423-426 / 26.310-372-373-422 / 32.310-33.372-33.423-40.423-40.463-41.423 MAN / STRALIS 430 / FE 420A												
KT50622	Milli (şaftlı) veya freze (25x6) çıkışlı												
ZF ECOSPLIT 16 S 151 TEK DİŞLİ	Pistonlu pompaya akuple (4 delikli bağlantı iso)												
	Dişli pompaya akuple 6x6 kaplinli (3 delikli bağlantı uni)												
	Kaplinli (flanşlı bağlantı)												
	-												

Ana Şanzıman: ZF ECOSPLIT 16 S 151-181-221-251 (13,80-13,85)													
	<table><tr><td>Product Number Ürün Numarası</td><td>Araçlar:17.322-19.422-423-426 / 26.310-372-373-422 / 32.310-33.372-33.423-40.423-40.463-41.423 MAN / STRALIS 430 / FE 420A</td></tr><tr><td>KT50623</td><td>Milli (şaftlı) veya freze (25x6) çıkışlı.</td></tr><tr><td>ZF ECOSPLIT 16 S 151 AKTARMALI</td><td>Pistonlu pompaya akuple (4 delikli bağlantı iso)</td></tr><tr><td></td><td>Dişli pompaya akuple 6x6 kaplinli (3 delikli bağlantı uni)</td></tr><tr><td></td><td>Kaplinli (flanşlı bağlantı)</td></tr><tr><td></td><td>-</td></tr></table>	Product Number Ürün Numarası	Araçlar:17.322-19.422-423-426 / 26.310-372-373-422 / 32.310-33.372-33.423-40.423-40.463-41.423 MAN / STRALIS 430 / FE 420A	KT50623	Milli (şaftlı) veya freze (25x6) çıkışlı.	ZF ECOSPLIT 16 S 151 AKTARMALI	Pistonlu pompaya akuple (4 delikli bağlantı iso)		Dişli pompaya akuple 6x6 kaplinli (3 delikli bağlantı uni)		Kaplinli (flanşlı bağlantı)		-
Product Number Ürün Numarası	Araçlar:17.322-19.422-423-426 / 26.310-372-373-422 / 32.310-33.372-33.423-40.423-40.463-41.423 MAN / STRALIS 430 / FE 420A												
KT50623	Milli (şaftlı) veya freze (25x6) çıkışlı.												
ZF ECOSPLIT 16 S 151 AKTARMALI	Pistonlu pompaya akuple (4 delikli bağlantı iso)												
	Dişli pompaya akuple 6x6 kaplinli (3 delikli bağlantı uni)												
	Kaplinli (flanşlı bağlantı)												
	-												

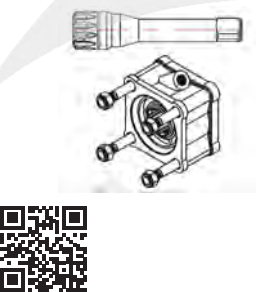
Ana Şanzıman:ZF ECOSPLIT16S 130-150-160-190-220(14,29-17,28)													
	<table><tr><td>Product Number Ürün Numarası</td><td>-17,06-13,80) (13,68-16,47-)(B:215) (450 rpm,SAĞ) Araçlar:16.281-19.280-19.422-25.372 (SLIENT)-26.231-26.280-26.281</td></tr><tr><td>KT50624</td><td>Milli (şaftlı) veya freze (25x6) çıkışlı</td></tr><tr><td>ZF ECOSPLIT 16 S 130 TEK DİŞLİ</td><td>Pistonlu pompaya akuple (4 delikli bağlantı iso)</td></tr><tr><td></td><td>Dişli pompaya akuple 6x6 kaplinli (3 delikli bağlantı uni)</td></tr><tr><td></td><td>Kaplinli (flanşlı bağlantı)</td></tr><tr><td></td><td>-</td></tr></table>	Product Number Ürün Numarası	-17,06-13,80) (13,68-16,47-)(B:215) (450 rpm,SAĞ) Araçlar:16.281-19.280-19.422-25.372 (SLIENT)-26.231-26.280-26.281	KT50624	Milli (şaftlı) veya freze (25x6) çıkışlı	ZF ECOSPLIT 16 S 130 TEK DİŞLİ	Pistonlu pompaya akuple (4 delikli bağlantı iso)		Dişli pompaya akuple 6x6 kaplinli (3 delikli bağlantı uni)		Kaplinli (flanşlı bağlantı)		-
Product Number Ürün Numarası	-17,06-13,80) (13,68-16,47-)(B:215) (450 rpm,SAĞ) Araçlar:16.281-19.280-19.422-25.372 (SLIENT)-26.231-26.280-26.281												
KT50624	Milli (şaftlı) veya freze (25x6) çıkışlı												
ZF ECOSPLIT 16 S 130 TEK DİŞLİ	Pistonlu pompaya akuple (4 delikli bağlantı iso)												
	Dişli pompaya akuple 6x6 kaplinli (3 delikli bağlantı uni)												
	Kaplinli (flanşlı bağlantı)												
	-												











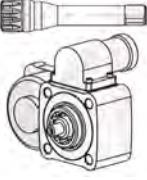

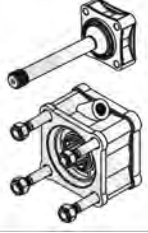
KT No.

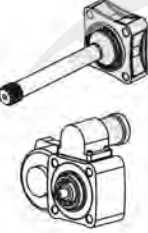

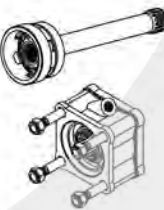
Replaces Ref. No:

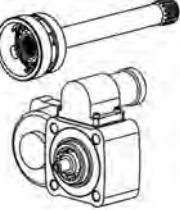
Description

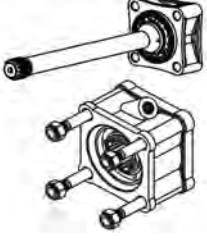

Model / Details

KT No.	Replaces Ref. No:	Description	Model / Details
 	Ana Şanzıman:ZF ECOSPLIT16S 130-150-160-190-220(14,29-17,28-17,06)		
	Product Number Ürün Numarası Araçlar:16.281-19.280-19.422-25.372 (SLIENT)-26.231-26.280-26.281-26.321-32.281-32.365-33.281 MAN / 1935-2228-2433-2624-2628	KT50286 Milli (şaftlı) veya freze (25x6) çıkışlı. Pistonlu pompaya akuple (4 delikli bağlantı iso) Dişli pompaya akuple 6x6 kaplinli (3 delikli bağlantı uni) Kaplinli (flanşlı bağlantı)	
 	Ana Şanzıman: ZF NEW ECOSPLIT 16 S 2521 TO (13,80)(B:250)U		
	Product Number Ürün Numarası Araçlar:14.463-39.390 MAN TGA-TGA 18.460A-19.430 MAN EUROPE 6X4 / 3300 DAF-85.330 DAF / RENAULT PREMIUM 440 DXI / IVECO	KT50287 Milli (şaftlı) veya freze (25x6) çıkışlı. Pistonlu pompaya akuple (4 delikli bağlantı iso) Dişli pompaya akuple 6x6 kaplinli (3 delikli bağlantı uni) Kaplinli (flanşlı bağlantı)	
 	Ana Şanzıman: ZF NEW ECOSPLIT 16 S 2521 TO(13,80)(B:250)		
	Product Number Ürün Numarası Araçlar:14.463-39.390 MAN TGA-TGA 18.460A-19.430 MAN EUROPE 6X4 / 3300 DAF-85.330 DAF / RENAULT PREMIUM 440 DXI / IVECO	KT50288 Milli (şaftlı) veya freze (25x6) çıkışlı. Pistonlu pompaya akuple (4 delikli bağlantı iso) Dişli pompaya akuple 6x6 kaplinli (3 delikli bağlantı uni) Kaplinli (flanşlı bağlantı)	
 	Ana Şanzıman: ZF AS TRONIC 12 AS 1800 IT / 16 AS 1800/16 AS 2200 IT		
	Product Number Ürün Numarası Araçlar:41.480 MAN TGA	KT50289 Milli (şaftlı) veya freze (25x6) çıkışlı. Pistonlu pompaya akuple (4 delikli bağlantı iso) Dişli pompaya akuple 6x6 kaplinli (3 delikli bağlantı uni) Kaplinli (flanşlı bağlantı)	
 	Ana Şanzıman: ZF AS TRONIC 12 AS 1800 IT / 16 AS 1800/16 AS 2200		
	Product Number Ürün Numarası Araçlar:41.480 MAN TGA	KT50290 Milli (şaftlı) veya freze (25x6) çıkışlı. Pistonlu pompaya akuple (4 delikli bağlantı iso) Dişli pompaya akuple 6x6 kaplinli (3 delikli bağlantı uni) Kaplinli (flanşlı bağlantı)	





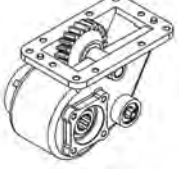

Ana Şanzıman: ZF AS TRONIC 16 AS 251 / 16 S 251+PLATE 12 AS 1631		
 	Product Number Ürün Numarası KT50625 ZF AS TRONIC 16 S 251 TEK DİŞLİ PLATE ROTERDAR	Araçlar: TG-A 18.460A -19.430 MAN EUROPE 6X4 / 3300 DAF-85.330 CF DAF /14.463 MAN / IVECO 480 STRALIS /39.390 MAN TGA Milli (şaftlı) veya freze (25x6) çıkışlı. Pistonlu pompaya akuple (4 delikli bağlantı iso) Dişli pompaya akuple 6x6 kaplinli (3 delikli bağlantı uni) Kaplinli (flanşlı bağlantı) -

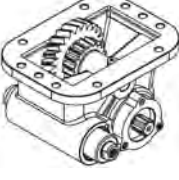
SCANIA P.T.O.

Ana Şanzıman:GS 770 - GS 771 - G 670 - GS 750 - GS 760 - GS 770		
 	Product Number Ürün Numarası KT50626 SCANIA GS771 50319522P0	Araçlar: 93-100H-111-112-113R-143P-82 H220-93 HG 230 SCANIA Seçeceğiniz Pompanın Dönüş yönü,Pto Dönüş Yönü ile Ters Olmalıdır. Milli (şaftlı) veya freze (25x6) çıkışlı. Pistonlu pompaya akuple (4 delikli bağlantı iso) Dişli pompaya akuple 6x6 kaplinli (3 delikli bağlantı uni) Kaplinli (flanşlı bağlantı)

Ana Şanzıman: GR 900/ GRH 900 (1065 rpm,SAĞ)		
 	Product Number Ürün Numarası KT50627 SCANIA GR900 UNI 50310512P0	Araçlar: 94 C 310-124 C 360-R 124 G 360-143 H 450 CV-143 M 400 CV-260H-143H-P 113M-P114-GA 380-114P-124R-113P Seçeceğiniz Pompanın Dönüş yönü,Pto Dönüş Yönü ile Ters Olmalıdır Milli (şaftlı) veya freze (25x6) çıkışlı Pistonlu pompaya akuple (4 delikli bağlantı iso) Dişli pompaya akuple 6x6 kaplinli (3 delikli bağlantı uni) Kaplinli (flanşlı bağlantı)

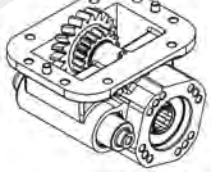
Ana Şanzıman: GRS 900 / GRS 890 / GRS 920 (1065 rpm,SAĞ)		
 	Product Number Ürün Numarası KT50628 SCANIA GRS900 UNI 50311512P0	Araçlar: 124 G 420-113-124 L 400-144 L 530-124 LA 420-144 LA 460 144 LA 530-R124 LA 420 R124 GA 420-143H-143M-143.400 Seçeceğiniz Pompanın Dönüş yönü,Pto Dönüş Yönü ile Ters Olmalıdır Milli (şaftlı) veya freze (25x6) çıkışlı. Pistonlu pompaya akuple (4 delikli bağlantı iso) Dişli pompaya akuple 6x6 kaplinli (3 delikli bağlantı uni) Kaplinli (flanşlı bağlantı)

Ana Şanzıman: GR 900/ GRH 900 (1065 rpm,SAĞ)		
 	Product Number Ürün Numarası KT50629 SCANIA GR900 ISO 50310522P0	Araçlar: 124 G 420-113-124 L 400-144 L 530-124 LA 420-144 LA 460 144 LA 530-R124 LA 420 R124 GA 420-143H-143M-143.400 Seçeceğiniz Pompanın Dönüş yönü,Pto Dönüş Yönü ile Ters Olmalıdır Milli (şaftlı) veya freze (25x6) çıkışlı. Pistonlu pompaya akuple (4 delikli bağlantı iso) Dişli pompaya akuple 6x6 kaplinli (3 delikli bağlantı uni) Kaplinli (flanşlı bağlantı)











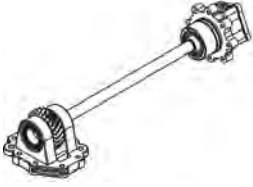

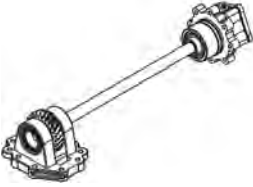
KT No.

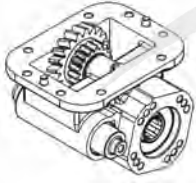

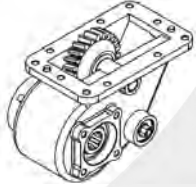
Replaces Ref. No:

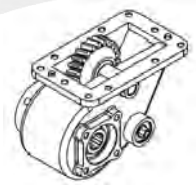
Description

Model / Details

 	Ana Şanzıman:GR 875/ GR 905 / GRS 905 / GRS 895 /GRSO 906	
	Product Number Ürün Numarası KT50291 SCANIA GRS905 50312421P0	Araçlar:R420-HG420-HG380 EURO 5 - R 500 SCANIA Seçeceğiniz Pompanın Dönüş yönü,Pto Dönüş Yönü ile Ters Olmalıdır. Milli (şaftlı) veya freze (25x6) çıkışlı. Pistonlu pompaya akuple (4 delikli bağlantı iso) Dişli pompaya akuple 6x6 kaplinli (3 delikli bağlantı uni) Kaplinli (flanşlı bağlantı)
 	Ana Şanzıman:GRSO 905	
	Product Number Ürün Numarası KT50292 SCANIA GRS0905 50314421P0	Araçlar:R420 / G420 SCANIA Seçeceğiniz Pompanın Dönüş yönü,Pto Dönüş Yönü ile Ters Olmalıdır Milli (şaftlı) veya freze (25x6) çıkışlı. Pistonlu pompaya akuple (4 delikli bağlantı iso) Dişli pompaya akuple 6x6 kaplinli (3 delikli bağlantı uni) Kaplinli (flanşlı bağlantı)
 	Ana Şanzıman: GR 801	
	Product Number Ürün Numarası KT50293 SCANIA GR801 ISO 50318522P0	Araçlar:R94 - 94 -220 -94-260 - 110H - P93 - P94DB - HP 210 - HP220 SCANIA Seçeceğiniz Pompanın Dönüş yönü,Pto Dönüş Yönü ile Ters Olmalıdır. Milli (şaftlı) veya freze (25x6) çıkışlı. Pistonlu pompaya akuple (4 delikli bağlantı iso) Dişli pompaya akuple 6x6 kaplinli (3 delikli bağlantı uni) Kaplinli (flanşlı bağlantı)
 	Ana Şanzıman:GR870-871 SCANIA (1000 rpm,SAĞ)	
	Product Number Ürün Numarası KT50294 SCANIA GR871 50316522P0	Araçlar:P92-93-111-112C-113R-114H-142M-144L-93H-280-R113M Seçeceğiniz Pompanın Dönüş yönü,Pto Dönüş Yönü ile Ters Olmalıdır. Milli (şaftlı) veya freze (25x6) çıkışlı. Pistonlu pompaya akuple (4 delikli bağlantı iso) Dişli pompaya akuple 6x6 kaplinli (3 delikli bağlantı uni) Kaplinli (flanşlı bağlantı)
 	Ana Şanzıman:GR 860	
	Product Number Ürün Numarası KT50295 SCANIA GR860 50320522P0	Araçlar:82H - 110 - 111 -112 - 113 - 140 - 141H - 143 SCANIA Seçeceğiniz Pompanın Dönüş yönü,Pto Dönüş Yönü ile Ters Olmalıdır. Milli (şaftlı) veya freze (25x6) çıkışlı. Pistonlu pompaya akuple (4 delikli bağlantı iso) Dişli pompaya akuple 6x6 kaplinli (3 delikli bağlantı uni) Kaplinli (flanşlı bağlantı)

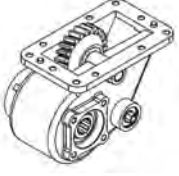



Ana Şanzıman:GR 880 - GRH 880	
 	Product Number Ürün Numarası Araçlar:P92 - 93- 111- 112C - 113R - 114H -142M - 144L - 93H 280 - R113M SCANIA P 113M - P114 GA 380 - 114 P - 124 R- 113P
KT50630	Seçeceğiniz Pompanın Dönüş yönü,Pto Dönüş Yönü ile Ters Olmalıdır
SCANIA GR880 50317522PO	Milli (şaftlı) veya freze (25x6) çıkışlı. Pistonlu pompaya akuple (4 delikli bağlantı iso) Dişli pompaya akuple 6x6 kaplinli (3 delikli bağlantı uni) Kaplinli (flanşlı bağlantı)

FULLER P.T.O.

Ana Şanzıman:EATON-FULLER 11612-12612-13612-15612-14607	
 	Product Number Ürün Numarası Araçlar:440E42-720E37 EUROTTECH-EUROTRACER-EUROSTAR / LEYLAND 80.330-85.330-85.400 DAF / 190.36-240.36 IVECO / FODEN 4275
KT50631	Seçeceğiniz Pompanın Dönüş yönü,Pto Dönüş Yönü ile Ters Olmalıdır.
FULLER KUYRUK 15612 50513321PO	Milli (şaftlı) veya freze (25x6) çıkışlı. Pistonlu pompaya akuple (4 delikli bağlantı iso) Dişli pompaya akuple 6x6 kaplinli (3 delikli bağlantı uni) -

Ana Şanzıman: RTO 11609-11613-11709-12709-14609 MRT0	
 	Product Number Ürün Numarası Araçlar: 19.361-26.321-26.240-26.280 MAN/180.24-280.26-190.26 -190.30-190.35-190.42-198.38-240.36-330.26-330.30-330.35-380
KT50632	Seçeceğiniz Pompanın Dönüş yönü,Pto Dönüş Yönü ile Ters Olmalıdır.
FULLER 11609 ISO 50510222PO	Milli (şaftlı) veya freze (25x6) çıkışlı. Pistonlu pompaya akuple (4 delikli bağlantı iso) Dişli pompaya akuple 6x6 kaplinli (3 delikli bağlantı uni) Kaplinli (flanşlı bağlantı)

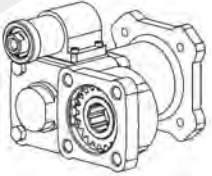
Ana Şanzıman:RTO 11609-11613-11709-12709-14609 MRT0 / RTX 9509-9513	
 	Product Number Ürün Numarası Araçlar: 19.361-26.321-26.240-26.280 MAN 180.24-280.26-190.26-190.30-190.35 -190.42-198.38-240.36-330.26-330.30-330.35-380E30 IVECO / 270-26 FATİH
KT50633	Seçeceğiniz Pompanın Dönüş yönü,Pto Dönüş Yönü ile Ters Olmalıdır.
FULLER 11609 UNI 50510212PO	Milli (şaftlı) veya freze (25x6) çıkışlı. Pistonlu pompaya akuple (4 delikli bağlantı iso) Dişli pompaya akuple 6x6 kaplinli (3 delikli bağlantı uni) Kaplinli (flanşlı bağlantı)

Ana Şanzıman:EATON-FULLER RT-RTF-RTO-RTX-RTOF-RTOX-MRT11609A-B	
 	Product Number Ürün Numarası Araçlar:19.361-26.321-26.240-26.280 MAN / 180.24-180-26-190.26-190.30-190.35-190.42-298.38-240.36-330.26-330.30-330.85-380E30 IVECO 270-26 FATİH
KT50634	Seçeceğiniz Pompanın Dönüş yönü,Pto Dönüş Yönü ile Ters Olmalıdır
FULLER KUYRUK 11609 50510321PO	Milli (şaftlı) veya freze (25x6) çıkışlı. Pistonlu pompaya akuple (4 delikli bağlantı iso) Dişli pompaya akuple 6x6 kaplinli (3 delikli bağlantı uni) Kaplinli (flanşlı bağlantı)











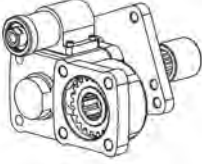

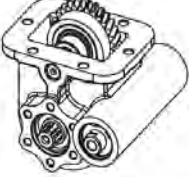
KT No.

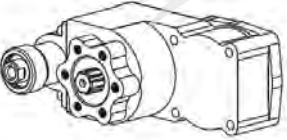
Replaces Ref. No:

Description

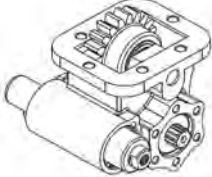
Model / Details

KT No.		Replaces Ref. No:	Description	Model / Details
 	Ana Şanzıman:RTSO 12316-14316-15316-17316 A (1000 rpm,SOL)			
	Product Number Ürün Numarası KT50296 FULLER KUYRUK 17316 50511321P0	Araçlar:19.413 SLIENT 19.314-19.364-19.464-18.403-35.403-21.314 -24.417-27.364 MAN 35.314-35.414-37.464-41.414 -41.603-41.464-50 Seçeceğiniz Pompanın Dönüş yönü,Pto Dönüş Yönü ile Ters Olmalıdır. Milli (şaftlı) veya freze (25x6) çıkışlı. Pistonlu pompaya akuple (4 delikli bağlantı iso) Dişli pompaya akuple 6x6 kaplinli (3 delikli bağlantı uni) Kaplinli (flanşlı bağlantı)		
EATON P.T.O.				
 	Ana Şanzıman:CHRYSLER -			
	Product Number Ürün Numarası KT50297 EATON 6406 PK 50422512P0	Araçlar:FS 6306 A_FS 5306 A _ 6406 Seçeceğiniz Pompanın Dönüş yönü,Pto Dönüş Yönü ile Ters Olmalıdır. Milli (şaftlı) veya freze (25x6) çıkışlı. Pistonlu pompaya akuple (4 delikli bağlantı iso) Dişli pompaya akuple 6x6 kaplinli (3 delikli bağlantı uni) Kaplinli (flanşlı bağlantı)		
 	Ana Şanzıman:EATON-HEMA 475 R SML-SMA-SMO-SME-CMA			
	Product Number Ürün Numarası KT50298 EATON HEMA 475 K 50410311P0	Araçlar: 105.08-110.08-145.22 FATİH / 2014-2114-FORD CARGO 1800 INTER / 1212-1312 FORD (83-86)1812-1814-2014-2117-2517 Seçeceğiniz Pompanın Dönüş yönü,Pto Dönüş Yönü ile Ters Olmalıdır. Milli (şaftlı) veya freze (25x6) çıkışlı. Pistonlu pompaya akuple (4 delikli bağlantı iso) Dişli pompaya akuple 6x6 kaplinli (3 delikli bağlantı uni) Kaplinli (flanşlı bağlantı)		
 	Ana Şanzıman: EATON-HEMA 475 L SML-SMA-SMO-SME-CMA-CMO			
	Product Number Ürün Numarası KT50299 HEMA EATON 475 L 50410511P0	Araçlar:105.08-110.08-145.22 FATİH / 2014-2114 FORD CARGO As600 DODGE / 1800 INTER / 1210-1212-1312 FORD (83-86) 1812-1814-2117 Seçeceğiniz Pompanın Dönüş yönü,Pto Dönüş Yönü ile Ters Olmalıdır. Milli (şaftlı) veya freze (25x6) çıkışlı Pistonlu pompaya akuple (4 delikli bağlantı iso) Dişli pompaya akuple 6x6 kaplinli (3 delikli bağlantı uni) Kaplinli (flanşlı bağlantı)		
 	Ana Şanzıman:EATON HEMA 475 R SML-SMA-SMO-SME-CMA-CMO			
	Product Number Ürün Numarası KT50300 EATON HEMA 475 R 50410512P0	Araçlar:105.08-110.08-145.22 FATİH /2014-2114 FORD CARGO 1800 INTER / 1212-1312 FORD (83-86) 1812-1814-2014*2117-2517 FORD Seçeceğiniz Pompanın Dönüş yönü,Pto Dönüş Yönü ile Ters Olmalıdır. Milli (şaftlı) veya freze (25x6) çıkışlı. Pistonlu pompaya akuple (4 delikli bağlantı iso) Dişli pompaya akuple 6x6 kaplinli (3 delikli bağlantı uni) Kaplinli (flanşlı bağlantı)		











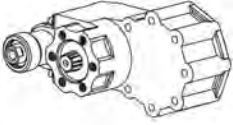

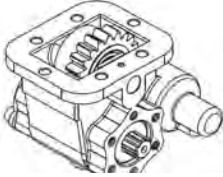
Model / Details

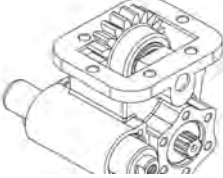

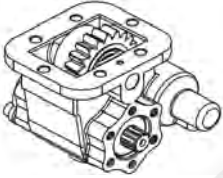







Description

Replaces Ref. No:

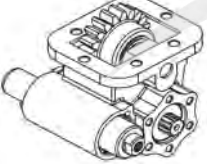
KT No.

 	Ana Şanzıman:EATON-HEMA 570-542-640 R SMA-SMS-SMR
	Product Number Ürün Numarası Araçlar:162.22-162.25-170.25- FATİH / 2114-2116-2517 FORD CARGO (86-96) 180 FATİH BMC BEDFORD GENETO / 1830
 	Ana Şanzıman:EATON-HEMA 570-542-640 L SMA-SMS-SMRSMH
	Product Number Ürün Numarası Araçlar:162.22-162.25-170.25 FATİH / 2114-2116-2517- FORD CARGO BEDFORD GENETO / 1830 INTER
 	Ana Şanzıman:EATON-HEMA 570-542-640 R SMA-SMS-SMR-SMH
	Product Number Ürün Numarası Araçlar:162.22-162.25-170.25 FATİH / 2114-2116-2517- FORD CARGO (86-96) 180 FATİH BMC BEDFORD GENETO / 1830 INTER / 1850
 	Ana Şanzıman:EATON FS/FSO/H/V 4106-5206 A/B/H (375 rpm,SOL)
	Product Number Ürün Numarası Araçlar:180-617-620-622 BMC PRO / 200.26-180 FATİH BMC 2520 FORD CARGO / AS 950 / CHRYSLER 180.12-210-220 CD-320
 	Ana Şanzıman:EATON FS/FSO/H/V 4106-5206 A/B/H (675 rpm,SOL)
	Product Number Ürün Numarası Araçlar:180-617-620-622 BMC PRO / 200.26-180 FATİH BMC 2520 FORD CARGO / AS 950 / CHRYSLER 180.12-210-220 CD

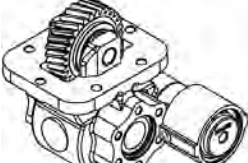
KT No.
Replaces Ref. No:
Description
Model / Details

 	Ana Şanzıman:EATON FS/FSO/H/V 4106-5206 A/B/H (750 rpm,SAĞ)
	Product Number Ürün Numarası Araçlar:180-617-620-622 BMC PRO / 200.26-180 FATİH BMC 2520 FORD CARGO / AS 950 / CHRYSLER180.12-210 KT50301 EATON 4106H 50412512P0
 	Ana Şanzıman:EATON FS/FSV/FSO/H/V 6109-6209-8209-8309A
	Product Number Ürün Numarası Araçlar:214.26-220.26-280 FATİH / 2520L-2621 FORD CARGO 522-822-620 BMC 280 / FODEN 3000 26.234-26.264-26.284 KT50302 EATON 6109K 50414321P0
 	Ana Şanzıman:EATON FS/FSV/FSO/H/V 6109-6209-8209-8309 A
	Product Number Ürün Numarası Araçlar:214.26-220.26-280 FATİH / 2520L-2621 FORD CARGO 522 -822-620 BMC 280 / FODEN 3000 26.234-26.264-26.284 MAN 6X2 KT50303 EATON 6109-8209 L 50414511P0
 	Ana Şanzıman:EATON FS/FSV/FSO/H/V 6109-6209-8209-8309 A
	Product Number Ürün Numarası Araçlar:214.26-220.26-280 FATİH / 2520L-2621 FORD CARGO 522 -822-620 BMC 280 / FODEN 3000 26.234-26.264-26.284 MAN 6X2 KT50304 EATON 6109H 50417512P0
ISUZU P.T.O.	
 	Ana Şanzıman: M153 / M150 / M 155 / M151 / M52 / H50 / H 260 /4VB /5VB
	Product Number Ürün Numarası Araçlar:HINO 300 DUTRO / TOYOTA WU 412L / DAIHATSU DELTA / TOYATO DYNA H260-200-400 KT50305 ISUZU HINO M153 VAKUMLU 50654512V0











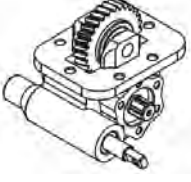

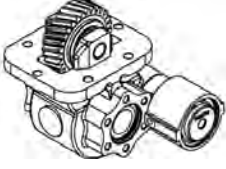
Model / Details

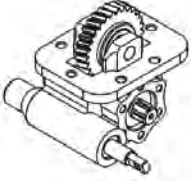
Description

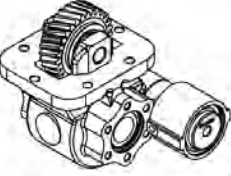
Replaces Ref. No:

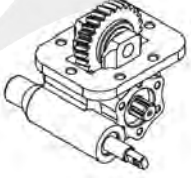
KT No.

Model / Details	Description	Replaces Ref. No:	KT No.
 	Ana Şanzıman:MSB-5S/MSB-5M/MSB-5G/MOA-89/MSB-5R (600 rpm,SAĞ) Product Number Ürün Numarası Araçlar:NKR 2.8 ISUZU LOW / NKR 55 LOW / NHR 55E / CARRIER 250T KT50640 ISUZU MSB 5S MEKANİK 50610512M0	Seçeceğiniz Pompanın Dönüş yönü,Pto Dönüş Yönü ile Ters Olmalıdır. Milli (şaftlı) veya freze (25x6) çıkışlı. Pistonlu pompaya akuple (4 delikli bağlantı iso) Dişli pompaya akuple 6x6 kaplinli (3 delikli bağlantı uni) Kaplinli (flanşlı bağlantı)	
 	Ana Şanzıman:MSB-5S/MSB-5M/MSB-5G/MOA-89/MSB-5R (600 rpm,SAĞ) Product Number Ürün Numarası Araçlar:NKR 2.8 ISUZU LOW / NKR 55 LOW / NHR 55E / CARRIER 250T KT50641 ISUZU MSB 5S VAKUMLU 50610512V0	Seçeceğiniz Pompanın Dönüş yönü,Pto Dönüş Yönü ile Ters Olmalıdır. Milli (şaftlı) veya freze (25x6) çıkışlı. Pistonlu pompaya akuple (4 delikli bağlantı iso) Dişli pompaya akuple 6x6 kaplinli (3 delikli bağlantı uni) Kaplinli (flanşlı bağlantı)	
 	Ana Şanzıman:MSA-5P/MSA-5G/SMA-SP/MSA-SP/MSA-5D (600 rpm,SAĞ) Product Number Ürün Numarası Araçlar:KS 11-KS 20-KS 21-KS 32-8.8 WIDE DIESEL-NKR 55L / 3.3 IRAN ISUZU NKR-NHR-NPR 3.6 / 3.9 ISUZU HVC SAH 1063 (LC 5 T 30) KT50642 ISUZU MSA 5P MEKANİK 50611512M0	Seçeceğiniz Pompanın Dönüş yönü,Pto Dönüş Yönü ile Ters Olmalıdır. Milli (şaftlı) veya freze (25x6) çıkışlı. Pistonlu pompaya akuple (4 delikli bağlantı iso) Dişli pompaya akuple 6x6 kaplinli (3 delikli bağlantı uni) Kaplinli (flanşlı bağlantı)	
 	Ana Şanzıman:MSA-5P/MSA-5G/SMA-SP/MSA-SP/MSA-5D (600 rpm,SAĞ) Product Number Ürün Numarası Araçlar:KS 11-KS 20-KS 21-KS 32-8.8 WIDE DIESEL-NKR 55L / 3.3 IRAN ISUZU NKR-NHR-NPR 3.6 / 3.9 ISUZU HVC SAH 1063 (LC 5 T 30) KT50643 ISUZU MSA 5P VAKUMLU 50611512V0	Seçeceğiniz Pompanın Dönüş yönü,Pto Dönüş Yönü ile Ters Olmalıdır. Milli (şaftlı) veya freze (25x6) çıkışlı. Pistonlu pompaya akuple (4 delikli bağlantı iso) Dişli pompaya akuple 6x6 kaplinli (3 delikli bağlantı uni) Kaplinli (flanşlı bağlantı)	
 	Ana Şanzıman:MXA-5R / MXA-5S / MSA-5D / MSA-5S MXA-6R / MXA 5C Product Number Ürün Numarası Araçlar:NKR WIDE LX 100 HP-4.3 NPR CHAMPION ISUZU / 3.2 NPR ISUZU NPR 66 / NHR 70 NKR 66 / NKR 66E / NPR 66P KT50644 ISUZU MXA 5R MEKANİK 50612512M0	Seçeceğiniz Pompanın Dönüş yönü,Pto Dönüş Yönü ile Ters Olmalıdır. Milli (şaftlı) veya freze (25x6) çıkışlı. Pistonlu pompaya akuple (4 delikli bağlantı iso) Dişli pompaya akuple 6x6 kaplinli (3 delikli bağlantı uni) Kaplinli (flanşlı bağlantı)	











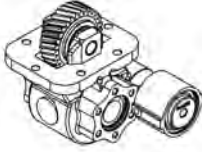

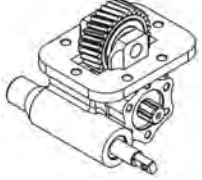
KT No.

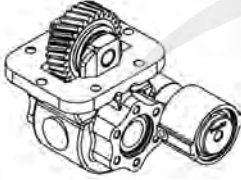
Replaces Ref. No:

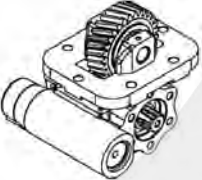
Description

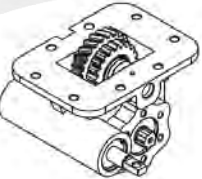
Model / Details

KT No.	Replaces Ref. No:	Description	Model / Details
 	Ana Şanzıman:MXA-5R / MXA-5S / MSA-5D / MSA-5S MXA-6R / MXA 5C		
	Product Number Ürün Numarası KT50306 ISUZU MXA 5R VAKUMLU 50612512V0	Araçlar: NKR WIDE LX 100 HP-4.3 NPR CHAMPION ISUZU / 3.2 NPR ISUZU NPR 66 / NHR 70 NKR 66 / NKR 66E / NPR 66P Seçeceğiniz Pompanın Dönüş yönü,Pto Dönüş Yönü ile Ters Olmalıdır. Milli (şaftlı) veya freze (25x6) çıkışlı. Pistonlu pompaya akuple (4 delikli bağlantı iso) Dişli pompaya akuple 6x6 kaplinli (3 delikli bağlantı uni) Kaplinli (flanşlı bağlantı)	
 	Ana Şanzıman:MOY-9F / MOY-9H /MOYCR (1000 rpm,SOL)		
	Product Number Ürün Numarası KT50307 ISUZU MOY 9F MK (MOY CR) 50617512M0	Araçlar: 4.3 NPR 66-71-75-77 ISUZU CHAMPION (2005-2006) / NKR 250 / NPR 250 NKR 66 E2L / ELF 130 / NPR 66L/NQR 71 PL/NPR85 / NPR 70 Seçeceğiniz Pompanın Dönüş yönü,Pto Dönüş Yönü ile Ters Olmalıdır. Milli (şaftlı) veya freze (25x6) çıkışlı. Pistonlu pompaya akuple (4 delikli bağlantı iso) Dişli pompaya akuple 6x6 kaplinli (3 delikli bağlantı uni) Kaplinli (flanşlı bağlantı)	
 	Ana Şanzıman:MOY-9F / MOY-9H /MOYCR (1000 rpm,SAĞ)		
	Product Number Ürün Numarası KT50308 ISUZU MOY CR VAKUMLU 50617512V0	Araçlar: 4.3 NPR 66-71-75-77 ISUZU CHAMPION (2005-2006) / NKR 250 / NPR 250 NKR 66 E2L Seçeceğiniz Pompanın Dönüş yönü,Pto Dönüş Yönü ile Ters Olmalıdır. Milli (şaftlı) veya freze (25x6) çıkışlı. Pistonlu pompaya akuple (4 delikli bağlantı iso) Dişli pompaya akuple 6x6 kaplinli (3 delikli bağlantı uni) Kaplinli (flanşlı bağlantı)	
 	Ana Şanzıman:MOY-9F / MOY-9H /MOYCR (1000 rpm,SAĞ)		
	Product Number Ürün Numarası KT50309 ISUZU MOY CR PNÖMATİK 50617512P0	Araçlar: NQR 4.8 TURBO ISUZU / NQR 70 P/FSR /LM 524 Seçeceğiniz Pompanın Dönüş yönü,Pto Dönüş Yönü ile Ters Olmalıdır. Milli (şaftlı) veya freze (25x6) çıkışlı. Pistonlu pompaya akuple (4 delikli bağlantı iso) Dişli pompaya akuple 6x6 kaplinli (3 delikli bağlantı uni) Kaplinli (flanşlı bağlantı)	
 	Ana Şanzıman:MBP-6P / MBF-5C / MBG-6P-6Q / MBG-5A /MBD-5A		
	Product Number Ürün Numarası KT50310 ISUZU MBP 6P MK 50613512M0	Araçlar: NQR 4.8 TURBO ISUZU / NQR 70 P/FSR /LM 524 Seçeceğiniz Pompanın Dönüş yönü,Pto Dönüş Yönü ile Ters Olmalıdır. Milli (şaftlı) veya freze (25x6) çıkışlı. Pistonlu pompaya akuple (4 delikli bağlantı iso) Dişli pompaya akuple 6x6 kaplinli (3 delikli bağlantı uni) Kaplinli (flanşlı bağlantı)	











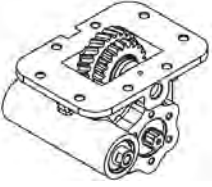

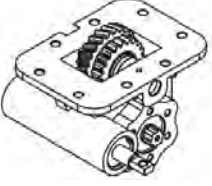
Model / Details

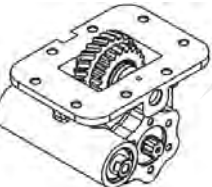
Description

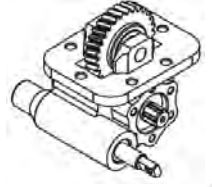
Replaces Ref. No:

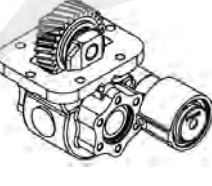
KT No.

Model / Details	Description	Replaces Ref. No:	KT No.
 	Ana Şanzıman:MBP-6P / MBF-5C / MBG-6P-6Q / MBG-5A /MBD-5A Product Number Ürün Numarası Araçlar:NQR 4.8 TURBO ISUZU / NQR 70 P/FSR /LM 524 KT50645 ISUZU MBP 6P PK 50613512P0	Seçeceğiniz Pompanın Dönüş yönü,Pto Dönüş Yönü ile Ters Olmalıdır Milli (şaftlı) veya freze (25x6) çıkışlı. Pistonlu pompaya akuple (4 delikli bağlantı iso) Dişli pompaya akuple 6x6 kaplinli (3 delikli bağlantı uni) Kaplinli (flanşlı bağlantı)	
 	Ana Şanzıman:MOZ-06 /MZZ-6U /MZZ-6W / MZZ-5L / MZZ-6C (700 rpm,SAĞ) Product Number Ürün Numarası Araçlar:NQR 4.8 3D TURBO ISUZU (2005)/NQR 71PL 5.2 ISUZU MOZ 95 KT50646 ISUZU MOZ 06 MK 50614512M0	Seçeceğiniz Pompanın Dönüş yönü,Pto Dönüş Yönü ile Ters Olmalıdır. Milli (şaftlı) veya freze (25x6) çıkışlı. Pistonlu pompaya akuple (4 delikli bağlantı iso) Dişli pompaya akuple 6x6 kaplinli (3 delikli bağlantı uni) Kaplinli (flanşlı bağlantı)	
 	Ana Şanzıman:MOZ-06 /MZZ-6U /MZZ-6W / MZZ-5L / MZZ-6C (700 rpm,SAĞ) Product Number Ürün Numarası Araçlar:NQR 4.8 3D TURBO ISUZU (2005)/NQR 71PL 5.2 ISUZU MOZ 95 KT50647 ISUZU MOZ 06 PK 50614512P0	Seçeceğiniz Pompanın Dönüş yönü,Pto Dönüş Yönü ile Ters Olmalıdır. Milli (şaftlı) veya freze (25x6) çıkışlı. Pistonlu pompaya akuple (4 delikli bağlantı iso) Dişli pompaya akuple 6x6 kaplinli (3 delikli bağlantı uni) Kaplinli (flanşlı bağlantı)	
 	Ana Şanzıman:33111-2065 / 08V0484 / 07L108LE05S / LH06S Product Number Ürün Numarası Araçlar:HINO L-100/FBC 112 SA KT50648 ISUZU HİNO L100-108 MEKANİK 50650512M0	Seçeceğiniz Pompanın Dönüş yönü,Pto Dönüş Yönü ile Ters Olmalıdır. Milli (şaftlı) veya freze (25x6) çıkışlı. Pistonlu pompaya akuple (4 delikli bağlantı iso) Dişli pompaya akuple 6x6 kaplinli (3 delikli bağlantı uni) Kaplinli (flanşlı bağlantı)	
 	Ana Şanzıman:33111-2065 / 08V0484 / 07L108LE05S / LH06S Product Number Ürün Numarası Araçlar:HINO L-100/FBC 112 SA KT50649 ISUZU HİNO L100-108 VAKUMLU 50650512V0	Seçeceğiniz Pompanın Dönüş yönü,Pto Dönüş Yönü ile Ters Olmalıdır. Milli (şaftlı) veya freze (25x6) çıkışlı. Pistonlu pompaya akuple (4 delikli bağlantı iso) Dişli pompaya akuple 6x6 kaplinli (3 delikli bağlantı uni) Kaplinli (flanşlı bağlantı)	











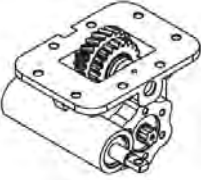

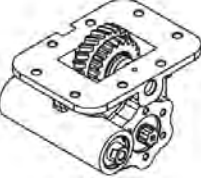
KT No.

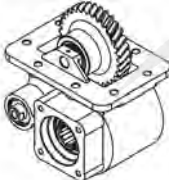
Replaces Ref. No:

Description

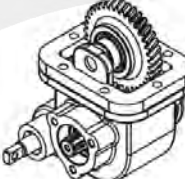
Model / Details

 	Ana Şanzıman: ISUZU MOZ 79-MOZ 95	
	Product Number Ürün Numarası KT50311 ISUZU MOZ 79 MK 50615512MO	Araçlar: Seçeceğiniz Pompanın Dönüş yönü, Pto Dönüş Yönü ile Ters Olmalıdır. Milli (şaftlı) veya freze (25x6) çıkışlı. Pistonlu pompaya akuple (4 delikli bağlantı iso) Dişli pompaya akuple 6x6 kaplinli (3 delikli bağlantı uni) Kaplinli (flanşlı bağlantı)
 	Ana Şanzıman: ISUZU MOZ 79-MOZ 95	
	Product Number Ürün Numarası KT50312 ISUZU MOZ 79 PK 50615512PO	Araçlar: Seçeceğiniz Pompanın Dönüş yönü, Pto Dönüş Yönü ile Ters Olmalıdır. Milli (şaftlı) veya freze (25x6) çıkışlı. Pistonlu pompaya akuple (4 delikli bağlantı iso) Dişli pompaya akuple 6x6 kaplinli (3 delikli bağlantı uni) Kaplinli (flanşlı bağlantı)
 	Ana Şanzıman: MLD-6A / MLD-6C, 6E, 6Q, 7R, 6B, 6D, 6F, 6R, 7Q, 6G	
	Product Number Ürün Numarası KT50313 ISUZU MLD 6A 50619521PO	Araçlar: 4.8 FTR ISUZU / FTR 33P / FTR33K / FNR / FVR5FF / FSR33L / FVR33P / LT132 / CHEVROLET FVR 32 ML Seçeceğiniz Pompanın Dönüş yönü, Pto Dönüş Yönü ile Ters Olmalıdır. Milli (şaftlı) veya freze (25x6) çıkışlı Pistonlu pompaya akuple (4 delikli bağlantı iso) Dişli pompaya akuple 6x6 kaplinli (3 delikli bağlantı uni) Kaplinli (flanşlı bağlantı)
 	Ana Şanzıman: ISUZU MZW 6 P, ISUZU MW 02 B, ISUZU MW00M-T1938805,	
	Product Number Ürün Numarası KT50314 ISUZU MZW 6P PK. 50621522PO	Araçlar: ISUZU TORA, ISUZU FORWARD-FV Seçeceğiniz Pompanın Dönüş yönü, Pto Dönüş Yönü ile Ters Olmalıdır. Milli (şaftlı) veya freze (25x6) çıkışlı. Pistonlu pompaya akuple (4 delikli bağlantı iso) Dişli pompaya akuple 6x6 kaplinli (3 delikli bağlantı uni) Kapiinli (flanşlı bağlantı)
 	Ana Şanzıman: M550	
	Product Number Ürün Numarası KT50315 ISUZU HINO M550 MK 50652512MO	Araçlar: HINO 614 / HINO 3615 Seçeceğiniz Pompanın Dönüş yönü, Pto Dönüş Yönü ile Ters Olmalıdır. Milli (şaftlı) veya freze (25x6) çıkışlı. Pistonlu pompaya akuple (4 delikli bağlantı iso) Dişli pompaya akuple 6x6 kaplinli (3 delikli bağlantı uni) Kaplinli (flanşlı bağlantı)





Model / Details

Description

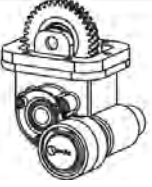

Replaces Ref. No:



KT No.

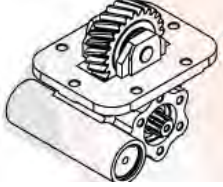

Ana Şanzıman: M550	
 	Product Number Ürün Numarası Araçlar:HINO 614 / HINO 3615
KT50650 ISUZU HINO M550 VK 50652512V0	Seçeceğiniz Pompanın Dönüş yönü,Pto Dönüş Yönü ile Ters Olmalıdır. Milli (şaftlı) veya freze (25x6) çıkışlı. Pistonlu pompaya akuple (4 delikli bağlantı iso) Dişli pompaya akuple 6x6 kaplinli (3 delikli bağlantı uni) Kaplinli (flanşlı bağlantı)

Ana Şanzıman: M153 / M150 / M 155 / M151 / M52 / H50 / H 260 /4VB /5VB	
 	Product Number Ürün Numarası Araçlar:HINO 300 DUTRO / TOYOTA WU 412L / DAIHATSU DELTA / TOYATO DYNA H260-200-400
KT50651 ISUZU HINO M153 MEKANİK 50654512M0	Seçeceğiniz Pompanın Dönüş yönü,Pto Dönüş Yönü ile Ters Olmalıdır. Milli (şaftlı) veya freze (25x6) çıkışlı. Pistonlu pompaya akuple (4 delikli bağlantı iso) Dişli pompaya akuple 6x6 kaplinli (3 delikli bağlantı uni) Kaplinli (flanşlı bağlantı)

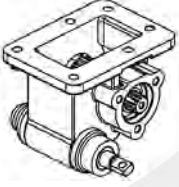
MITSUBISHI P.T.O.

Ana Şanzıman:MO 60S5 / 60S6 / 50S5	
 	Product Number Ürün Numarası Araçlar:MITSUBISHI 657 / FM 1060
KT50652 MITSUBISHI MO60S5 PNÖMATİK 50721512P0	Seçeceğiniz Pompanın Dönüş yönü,Pto Dönüş Yönü ile Ters Olmalıdır. Milli (şaftlı) veya freze (25x6) çıkışlı. Pistonlu pompaya akuple (4 delikli bağlantı iso) Dişli pompaya akuple 6x6 kaplinli (3 delikli bağlantı uni) Kaplinli (flanşlı bağlantı)

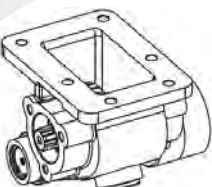
Ana Şanzıman:M1S5-M2S5-M3S (375 rpm,SAĞ)	
 	Product Number Ürün Numarası Araçlar:444-449 CANTER MITSUBISHI (704) / H350/ 3F 412 / Hd35 -HD50-65-72-77 HYUNDAI
KT50653 MITSUBISHI M1S5 MK 50710512M0	Seçeceğiniz Pompanın Dönüş yönü,Pto Dönüş Yönü ile Ters Olmalıdır. Milli (şaftlı) veya freze (25x6) çıkışlı. Pistonlu pompaya akuple (4 delikli bağlantı iso) Dişli pompaya akuple 6x6 kaplinli (3 delikli bağlantı uni) Kaplinli (flanşlı bağlantı)

Ana Şanzıman:M1S5-M2S5-M3S (375 rpm,SAĞ)	
 	Product Number Ürün Numarası Araçlar:444-449 CANTER MITSUBISHI (704) / H350/ 3F 412 / Hd35 -HD50-65-72-77 HYUNDAI
KT50654 MITSUBISHI M1S5 VAKUMLU 50710512V0	Seçeceğiniz Pompanın Dönüş yönü,Pto Dönüş Yönü ile Ters Olmalıdır. Milli (şaftlı) veya freze (25x6) çıkışlı. Pistonlu pompaya akuple (4 delikli bağlantı iso) Dişli pompaya akuple 6x6 kaplinli (3 delikli bağlantı uni) Kaplinli (flanşlı bağlantı)











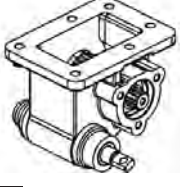

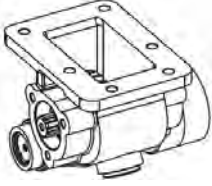
KT No.

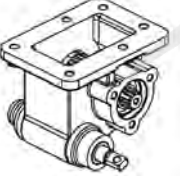
Replaces Ref. No:

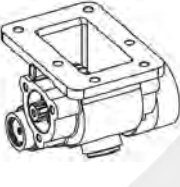
Description

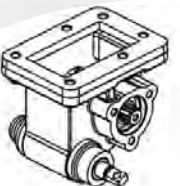
Model / Details

 	Ana Şanzıman:MO 15 S 5 (375 rpm,SAĞ)	
	Product Number Ürün Numarası KT50316 MITSUBISHI MO15S5 MK 50712512M0	Araçlar: FE 511-711 MITSUBISHI Seçeceğiniz Pompanın Dönüş yönü,Pto Dönüş Yönü ile Ters Olmalıdır. Milli (şaftlı) veya freze (25x6) çıkışlı. Pistonlu pompaya akuple (4 delikli bağlantı iso) Dişli pompaya akuple 6x6 kaplinli (3 delikli bağlantı uni) Kaplinli (flanşlı bağlantı)
 	Ana Şanzıman:MO 15 S 5 (375 rpm,SAĞ)	
	Product Number Ürün Numarası KT50317 MITSUBISHI MO15S5 VAKUMLU 50712512V0	Araçlar: FE 511-711 MITSUBISHI Seçeceğiniz Pompanın Dönüş yönü,Pto Dönüş Yönü ile Ters Olmalıdır. Milli (şaftlı) veya freze (25x6) çıkışlı. Pistonlu pompaya akuple (4 delikli bağlantı iso) Dişli pompaya akuple 6x6 kaplinli (3 delikli bağlantı uni) Kaplinli (flanşlı bağlantı)
 	Ana Şanzıman:MO 25 S 5 (350 rpm,SAĞ)	
	Product Number Ürün Numarası KT50318 MITSUBISHI MO25S5 MK 50713512M0	Araçlar: 635 FE-515 FE-519 FE-FE 534-FE 544-FB 634-FE 639C-839-859 G MITSUBISHI (739) FE130C1 CANTER 2.0 SUPER LOW Seçeceğiniz Pompanın Dönüş yönü,Pto Dönüş Yönü ile Ters Olmalıdır. Milli (şaftlı) veya freze (25x6) çıkışlı. Pistonlu pompaya akuple (4 delikli bağlantı iso) Dişli pompaya akuple 6x6 kaplinli (3 delikli bağlantı uni) Kaplinli (flanşlı bağlantı)
 	Ana Şanzıman:MO 25 S 5 (350 rpm,SAĞ)	
	Product Number Ürün Numarası KT50319 MITSUBISHI MO25S5 VAKUMLU 50713512M0	Araçlar: 635 FE-515 FE-519 FE-FE 534-FE 544-FB 634-FE 639 C-839-859 G MITSUBISHI (739) FE130C1 CANTER 2.0 SUPER LOW Seçeceğiniz Pompanın Dönüş yönü,Pto Dönüş Yönü ile Ters Olmalıdır. Milli (şaftlı) veya freze (25x6) çıkışlı. Pistonlu pompaya akuple (4 delikli bağlantı iso) Dişli pompaya akuple 6x6 kaplinli (3 delikli bağlantı uni) Kapiinli (flanşlı bağlantı)
 	Ana Şanzıman:MO 26 S 5 / 27 S 5 (4,748)	
	Product Number Ürün Numarası KT50320 MITSUBISHI MO26S5 MK 50714512M0	Araçlar: FE 730-FE 839EURO 4 FE71BB / FE73BE / FE83BC Seçeceğiniz Pompanın Dönüş yönü,Pto Dönüş Yönü ile Ters Olmalıdır. Milli (şaftlı) veya freze (25x6) çıkışlı. Pistonlu pompaya akuple (4 delikli bağlantı iso) Dişli pompaya akuple 6x6 kaplinli (3 delikli bağlantı uni) Kaplinli (flanşlı bağlantı)



Model / Details	Description	Replaces Ref. No:	KT No.
-----------------	-------------	-------------------	--------

 	Ana Şanzıman:MO 26 S 5 / 27 S 5 (4,748)
	Product Number Ürün Numarası Araçlar:FE 730-FE 839EURO 4 FE71BB / FE73BE / FE83BC
 	Ana Şanzıman:MO 35 S 5 / MO 35 T3 (350 rpm,SAĞ)
	Product Number Ürün Numarası Araçlar:FE 649-659-FE 859 E MITSUBISHI (722) / FE150C1-150E1 -FE150E2 CANTER 2.0T / WIDE CAB FG145C1 4X4 CANTER
 	Ana Şanzıman:MO 35 S 5 / MO 35 T3 (350 rpm,SAĞ)
	Product Number Ürün Numarası Araçlar:FE 649-659-FE 859 E MITSUBISHI (722) / FE150C1-150E1 -FE150E2 CANTER 2.0T / WIDE CAB FG145C1 4X4 CANTER 2.5
 	Ana Şanzıman:MO 36 S 6 (5,400)
	Product Number Ürün Numarası Araçlar:FE 859 GEURO 4 FE85BE / FE85BG
 	Ana Şanzıman:MO 36 S 6 (5,400)
	Product Number Ürün Numarası Araçlar:FE 859 GEURO 4 FE85BE / FE85BG











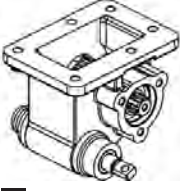

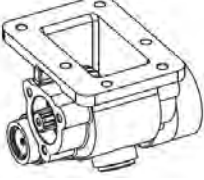
KT No.

Replaces Ref. No:

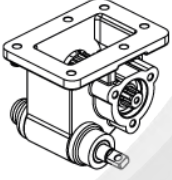

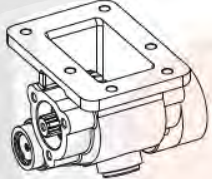
Description



Model / Details

		Ana Şanzıman:MO 38 S5	
 	Product Number Ürün Numarası	Araçlar:MITSUBISHI	
	KT50321 MITSUBISHI MO38S5 MK 50719512MO	Seçeceğiniz Pompanın Dönüş yönü,Pto Dönüş Yönü ile Ters Olmalıdır. Millî (şaftlı) veya freze (25x6) çıkışlı. Pistonlu pompaya akuple (4 delikli bağlantı iso) Dişli pompaya akuple 6x6 kaplinli (3 delikli bağlantı uni) Kaplinli (flanşlı bağlantı)	
 	Product Number Ürün Numarası	Araçlar:MITSUBISHI	
	KT50322 MITSUBISHI MO38S5 VAKUMLU 50719512V0	Seçeceğiniz Pompanın Dönüş yönü,Pto Dönüş Yönü ile Ters Olmalıdır. Millî (şaftlı) veya freze (25x6) çıkışlı. Pistonlu pompaya akuple (4 delikli bağlantı iso) Dişli pompaya akuple 6x6 kaplinli (3 delikli bağlantı uni) Kaplinli (flanşlı bağlantı)	
 	Product Number Ürün Numarası	Araçlar:MITSUBISHI	
	KT50323 MITSUBISHI MO38S5 VAKUMLU MÜŞÜRLÜ 50719512V1	Seçeceğiniz Pompanın Dönüş yönü,Pto Dönüş Yönü ile Ters Olmalıdır. Millî (şaftlı) veya freze (25x6) çıkışlı. Pistonlu pompaya akuple (4 delikli bağlantı iso) Dişli pompaya akuple 6x6 kaplinli (3 delikli bağlantı uni) Kaplinli (flanşlı bağlantı)	
 	Product Number Ürün Numarası	Araçlar:FH 215 DRAGON MITSUBISHI / 500 HYUNDAI(802) / FK 750	
	KT50324 MITSUBISHI MO50S6 MK 50720512MO	Seçeceğiniz Pompanın Dönüş yönü,Pto Dönüş Yönü ile Ters Olmalıdır. Millî (şaftlı) veya freze (25x6) çıkışlı. Pistonlu pompaya akuple (4 delikli bağlantı iso) Dişli pompaya akuple 6x6 kaplinli (3 delikli bağlantı uni) Kaplinli (flanşlı bağlantı)	
 	Product Number Ürün Numarası	Araçlar:FH 215 DRAGON MITSUBISHI / 500 HYUNDAI(802) / FK 750	
	KT50325 MITSUBISHI MO50S6 VK 50720512V0	Seçeceğiniz Pompanın Dönüş yönü,Pto Dönüş Yönü ile Ters Olmalıdır. Millî (şaftlı) veya freze (25x6) çıkışlı. Pistonlu pompaya akuple (4 delikli bağlantı iso) Dişli pompaya akuple 6x6 kaplinli (3 delikli bağlantı uni) Kaplinli (flanşlı bağlantı)	







LIAZ P.T.O.

Ana Şanzıman:Liaz (513 rpm,SAĞ)	
 	Product Number Ürün Numarası Araçlar:Liaz
KT50660	Seçeceğiniz Pompanın Dönüş yönü,Pto Dönüş Yönü ile Ters Olmalıdır.
LIAZ 1	Milli (şaftlı) veya freze (25x6) çıkışlı.
51310422PO	Pistonlu pompaya akuple (4 delikli bağlantı iso)
	Dişli pompaya akuple 6x6 kaplinli (3 delikli bağlantı uni) flanşlı



Ana Şanzıman:Liaz (675 rpm,SOL)	
 	Product Number Ürün Numarası Araçlar:Liaz
KT50661	Seçeceğiniz Pompanın Dönüş yönü,Pto Dönüş Yönü ile Ters Olmalıdır.
LIAZ 2	Milli (şaftlı) veya freze (25x6) çıkışlı.
51311421PO	Pistonlu pompaya akuple (4 delikli bağlantı iso)
	Dişli pompaya akuple 6x6 kaplinli (3 delikli bağlantı uni) Kaplinli (flanşlı bağlantı)

FOTON P.T.O.

Ana Şanzıman: WLY6S51B- 40A-00	
 	Product Number Ürün Numarası Araçlar: L0171010184A0 -5,51 FOTON
KT50662	Seçeceğiniz Pompanın Dönüş yönü,Pto Dönüş Yönü ile Ters Olmalıdır.
FOTON ATLAS	Milli (şaftlı) veya freze (25x6) çıkışlı.
51910512PO	Pistonlu pompaya akuple (4 delikli bağlantı iso)
	Dişli pompaya akuple 6x6 kaplinli (3 delikli bağlantı uni) Kaplinli (flanşlı bağlantı)

Ana Şanzıman:WLY6S51B-40B-00	
 	Product Number Ürün Numarası Araçlar: L0171010184AQ 5,522 - 0,795-4,0L FOTON
KT50663	Seçeceğiniz Pompanın Dönüş yönü,Pto Dönüş Yönü ile Ters Olmalıdır.
FOTON ATLAS YENİ	Milli (şaftlı) veya freze (25x6) çıkışlı.
51911512PO	Pistonlu pompaya akuple (4 delikli bağlantı iso)
	Dişli pompaya akuple 6x6 kaplinli (3 delikli bağlantı uni) Kaplinli (flanşlı bağlantı)

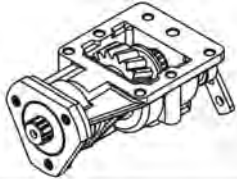
IVECO P.T.O.

Ana Şanzıman:2826.5 IVECO (1000 rpm,SOL)	
 	Product Number Ürün Numarası Araçlar:30.10-35.10-35.12-49.10-49.12-59.12-60.12 IVECO
KT50664	Seçeceğiniz Pompanın Dönüş yönü,Pto Dönüş Yönü ile Ters Olmalıdır.
IVECO 2826 MK	Milli (şaftlı) veya freze (25x6) çıkışlı.
50818511M0	Pistonlu pompaya akuple (4 delikli bağlantı iso)
	Dişli pompaya akuple 6x6 kaplinli (3 delikli bağlantı uni) Kaplinli (flanşlı bağlantı)











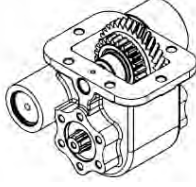

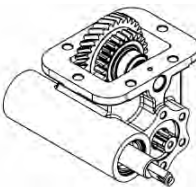
KT No.

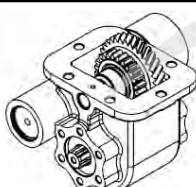
Replaces Ref. No:

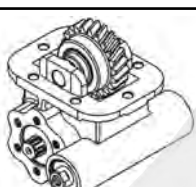

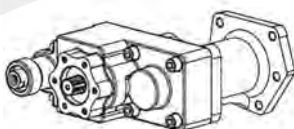





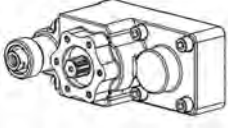

Description

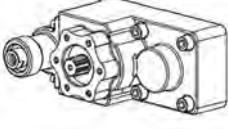
Model / Details

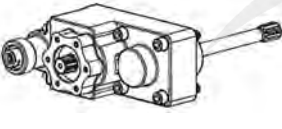
 	<p>Ana Şanzıman:2840.6 - FPT 2840.6 18A - FPT 2840.6 21M(700 rpm,SAĞ)</p> <p>Product Number Ürün Numarası Araçlar:IVECO 45C15 -DAILY 4X4 - 50C18 - 35C15 - 50C15 - IVECO 65C15 - 70C15 IVECO DAILY 4X4 55S18 / NISSAN ATLEON 56.15 /</p> <p>KT50326 Seçeceğiniz Pompanın Dönüş yönü,Pto Dönüş Yönü ile Ters Olmalıdır.</p> <p>IVECO 2840.6 YAN VAKUMLU 50810512V0 Milli (şaftlı) veya freze (25x6) çıkışlı. Pistonlu pompaya akuple (4 delikli bağlantı iso) Dişli pompaya akuple 6x6 kaplinli (3 delikli bağlantı uni) Kaplinli (flanşlı bağlantı)</p>
 	<p>Ana Şanzıman:2840.6 - FPT 2840.6 18A - FPT 2840.6 21M(700 rpm,SAĞ)</p> <p>Product Number Ürün Numarası Araçlar:IVECO 45C15 -DAILY 4X4 - 50C18 - 35C15 - 50C15 - IVECO 65C15 - 70C15 IVECO DAILY 4X4 55S18 / NISSAN ATLEON 56.15 /</p> <p>KT50327 Seçeceğiniz Pompanın Dönüş yönü,Pto Dönüş Yönü ile Ters Olmalıdır.</p> <p>IVECO 2840.6 YAN MEKANİK 50810512M0 Milli (şaftlı) veya freze (25x6) çıkışlı. Pistonlu pompaya akuple (4 delikli bağlantı iso) Dişli pompaya akuple 6x6 kaplinli (3 delikli bağlantı uni) Kaplinli (flanşlı bağlantı)</p>
 	<p>Ana Şanzıman:2840.6 - FPT 2840.6 18A - FPT 2840.6 21M(700 rpm,SAĞ)</p> <p>Product Number Ürün Numarası Araçlar:IVECO 45C15 -DAILY 4X4 - 50C18 - 35C15 - 50C15 - IVECO 65C15 - 70C15 IVECO DAILY 4X4 55S18 / NISSAN ATLEON 56.15 /</p> <p>KT50328 Seçeceğiniz Pompanın Dönüş yönü,Pto Dönüş Yönü ile Ters Olmalıdır.</p> <p>IVECO 2840.6 YAN ÇİFT TESİRLİ VAKUMLU 50810512V0 Milli (şaftlı) veya freze (25x6) çıkışlı. Pistonlu pompaya akuple (4 delikli bağlantı iso) Dişli pompaya akuple 6x6 kaplinli (3 delikli bağlantı uni) Kaplinli (flanşlı bağlantı)</p>
 	<p>Ana Şanzıman:2845.6-2855.6 IVECO (1000 rpm,SAĞ)</p> <p>Product Number Ürün Numarası Araçlar:IVECO 60.10-60.12-75.14-80.12-80.14-85.12-85.14-120.14-140.14 -150.14-130E15-150E21-220E21-60.14-65E12-65E14-75.12-75E14-75E15</p> <p>KT50329 Seçeceğiniz Pompanın Dönüş yönü,Pto Dönüş Yönü ile Ters Olmalıdır.</p> <p>IVECO 2855 YAN 50812512P0 Milli (şaftlı) veya freze (25x6) çıkışlı. Pistonlu pompaya akuple (4 delikli bağlantı iso) Dişli pompaya akuple 6x6 kaplinli (3 delikli bağlantı uni) Kaplinli (flanşlı bağlantı)</p>
 	<p>Ana Şanzıman:2846.5-2842-2835-2830-2646 (500 rpm,SOL)</p> <p>Product Number Ürün Numarası Araçlar:FIAT IVECO / 65.15-79.13-79.14-80.14 IVECO / 65.12-79.12 -95.14 100.13-109.14-135.14 ZETA IVECO</p> <p>KT50330 Seçeceğiniz Pompanın Dönüş yönü,Pto Dönüş Yönü ile Ters Olmalıdır.</p> <p>IVECO 2846 PK KUYRUK 50811311P0 Milli (şaftlı) veya freze (25x6) çıkışlı. Pistonlu pompaya akuple (4 delikli bağlantı iso) Dişli pompaya akuple 6x6 kaplinli (3 delikli bağlantı uni) Kaplinli (flanşlı bağlantı)</p>

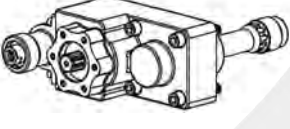

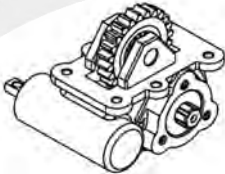
Model / Details	Description	Replaces Ref. No:	KT No.
-----------------	-------------	-------------------	--------

 	<p>Ana Şanzıman:2845.6-2855.6 (650 rpm,SOL)</p> <p>Product Number Ürün Numarası Araçlar:IVECO 60.10-60.12-75.14-80.14-80.12-85.12-85.14-120.14-140.14-150.14-130E15-150E21-220E21-60.14-65E12-65E14-75.12-75E14-</p> <p>KT50665 Seçeceğiniz Pompanın Dönüş yönü,Pto Dönüş Yönü ile Ters Olmalıdır.</p> <p>IVECO 2855 PK KUYRUK 50812311P0 Milli (şaftlı) veya freze (25x6) çıkışlı. Pistonlu pompaya akuple (4 delikli bağlantı iso) Dişli pompaya akuple 6x6 kaplinli (3 delikli bağlantı uni) Kaplinli (flanşlı bağlantı)</p>
 	<p>Ana Şanzıman:2865.6 (650 rpm,SOL)</p> <p>Product Number Ürün Numarası Araçlar:JOHNSTON 12E18 IVECO EUROCARGO / 100E21-120E18-120E23-130E23-180E18-260E18-80.21-100.18-120.23-130.23-150.18-</p> <p>KT50666 Seçeceğiniz Pompanın Dönüş yönü,Pto Dönüş Yönü ile Ters Olmalıdır.</p> <p>IVECO 2865 PK KUYRUK 50813311P0 Milli (şaftlı) veya freze (25x6) çıkışlı. Pistonlu pompaya akuple (4 delikli bağlantı iso) Dişli pompaya akuple 6x6 kaplinli (3 delikli bağlantı uni) Kaplinli (flanşlı bağlantı)</p>
 	<p>Ana Şanzıman:2870.9 (675 rpm,SOL)</p> <p>Product Number Ürün Numarası Araçlar:120E18-120E23-130E15-130E18-130E23-150E15-150E18-150E23-170E18-170E23-180E21-250E21-100E18-100E23-100E15-130E15</p> <p>KT50667 Seçeceğiniz Pompanın Dönüş yönü,Pto Dönüş Yönü ile Ters Olmalıdır.</p> <p>IVECO 2870 PK KUYRUK 50814311P0 Milli (şaftlı) veya freze (25x6) çıkışlı. Pistonlu pompaya akuple (4 delikli bağlantı iso) Dişli pompaya akuple 6x6 kaplinli (3 delikli bağlantı uni) Kaplinli (flanşlı bağlantı)</p>
 	<p>Ana Şanzıman:2895.9 (675 rpm,SOL)</p> <p>Product Number Ürün Numarası Araçlar:120E18-120E23-130E15-130E18-130E23-150E15-150E18-150E23-170E18-170E23-180E21-180E18-100E18-100E23-100E15-130E15</p> <p>KT50668 Seçeceğiniz Pompanın Dönüş yönü,Pto Dönüş Yönü ile Ters Olmalıdır.</p> <p>IVECO 2895 PK KUYRUK 50815311P0 Milli (şaftlı) veya freze (25x6) çıkışlı. Pistonlu pompaya akuple (4 delikli bağlantı iso) Dişli pompaya akuple 6x6 kaplinli (3 delikli bağlantı uni) Kaplinli (flanşlı bağlantı)</p>
 	<p>Ana Şanzıman:2828.5-2831.5-28028-28031 (300 rpm,SAĞ)</p> <p>Product Number Ürün Numarası Araçlar:35.9-65.9-35 NC-50 NC-50.9-50.11 IVECO</p> <p>KT50669 Seçeceğiniz Pompanın Dönüş yönü,Pto Dönüş Yönü ile Ters Olmalıdır.</p> <p>IVECO 2828 MEKANİK 50816512M0 Milli (şaftlı) veya freze (25x6) çıkışlı. Pistonlu pompaya akuple (4 delikli bağlantı iso) Dişli pompaya akuple 6x6 kaplinli (3 delikli bağlantı uni) Kaplinli (flanşlı bağlantı)</p>









KT No.

Replaces Ref. No:

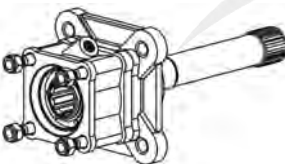
Description

Model / Details

Ana Şanzıman:475L-R SMLX (1000 rpm,SAĞ)			
 	Product Number Ürün Numarası Araçlar:75.12 IVECO-85.12 IVECO		
	KT50331 IVECO 475 SMLX MEKANİK 50817512MO	Seçeceğiniz Pompanın Dönüş yönü,Pto Dönüş Yönü ile Ters Olmalıdır. Milli (şaftlı) veya freze (25x6) çıkışlı. Pistonlu pompaya akuple (4 delikli bağlantı iso) Dişli pompaya akuple 6x6 kaplinli (3 delikli bağlantı uni) Kaplinli (flanşlı bağlantı)	
	Product Number Ürün Numarası Araçlar:75.12 IVECO-85.12 IVECO	KT50332 IVECO 475 SMLX PNÖMATİK 50817512PO	Seçeceğiniz Pompanın Dönüş yönü,Pto Dönüş Yönü ile Ters Olmalıdır. Milli (şaftlı) veya freze (25x6) çıkışlı. Pistonlu pompaya akuple (4 delikli bağlantı iso) Dişli pompaya akuple 6x6 kaplinli (3 delikli bağlantı uni) Kaplinli (flanşlı bağlantı)
	Product Number Ürün Numarası Araçlar:75.12 IVECO-85.12 IVECO	KT50333 VOLVO R 1400 / 1700 TEK DİŞLİ UZUN KARDAN MİLLİ 50915322P	Seçeceğiniz Pompanın Dönüş yönü,Pto Dönüş Yönü ile Ters Olmalıdır. Milli (şaftlı) veya freze (25x6) çıkışlı. Pistonlu pompaya akuple (4 delikli bağlantı iso) Dişli pompaya akuple 6x6 kaplinli (3 delikli bağlantı uni) Kaplinli (flanşlı bağlantı)
Ana Şanzıman:SR/R 1000-1400-1700-1900-2000-SRO 2400			
 	Product Number Ürün Numarası Araçlar:FL 10 320-NL 12-FH 16 520-FH 12 420-FM 12-FH 12-FH16-FM-FM 10 -FM 12 VOLVO FL 616-FL 7-F 10-FL 10-F 12-F 16-N 10-N 12-FL 7-NL 12-F 16		
	KT50333 VOLVO R 1400 / 1700 TEK DİŞLİ UZUN KARDAN MİLLİ 50915322P	Seçeceğiniz Pompanın Dönüş yönü,Pto Dönüş Yönü ile Ters Olmalıdır. Milli (şaftlı) veya freze (25x6) çıkışlı. Pistonlu pompaya akuple (4 delikli bağlantı iso) Dişli pompaya akuple 6x6 kaplinli (3 delikli bağlantı uni) Kaplinli (flanşlı bağlantı)	
	Product Number Ürün Numarası Araçlar:FL 10 320-NL 12-FH 16 520-FH 12 420-FM 12-FH 12-FH 16-FM-FM 10 -FM 12 VOLVO FL 616-FL 7-F 10-FL 10-F 12-F 16-N 10-N 12-FL 7-NL 12-F 16	KT50334 VOLVO R 1400 / 1700 ÇİFT DİŞLİ UZUN KARDAN MİLLİ 50915321PO	Seçeceğiniz Pompanın Dönüş yönü,Pto Dönüş Yönü ile Ters Olmalıdır. Milli (şaftlı) veya freze (25x6) çıkışlı. Pistonlu pompaya akuple (4 delikli bağlantı iso) Dişli pompaya akuple 6x6 kaplinli (3 delikli bağlantı uni) Kaplinli (flanşlı bağlantı)
	Product Number Ürün Numarası Araçlar:FL 10 320-NL 12-FH 16 520-FH 12 420-FM 12-FH 12-FH 16-FM-FM 10 -FM 12 VOLVO FL 616-FL 7-F 10-FL 10-F 12-F 16-N 10-N 12-FL 7-NL 12-F 16	KT50335 VOLVO R5 - SR 52 TEK DİŞLİ 50910322PO	Seçeceğiniz Pompanın Dönüş yönü,Pto Dönüş Yönü ile Ters Olmalıdır. Milli (şaftlı) veya freze (25x6) çıkışlı. Pistonlu pompaya akuple (4 delikli bağlantı iso) Dişli pompaya akuple 6x6 kaplinli (3 delikli bağlantı uni) Kaplinli (flanşlı bağlantı)
Ana Şanzıman:R 51-R / SR 52 / R52 (SAĞ)			
 	Product Number Ürün Numarası Araçlar:VOLVO F 7-F 10-F 86-F 88-F 1233		
	KT50335 VOLVO R5 - SR 52 TEK DİŞLİ 50910322PO	Seçeceğiniz Pompanın Dönüş yönü,Pto Dönüş Yönü ile Ters Olmalıdır. Milli (şaftlı) veya freze (25x6) çıkışlı. Pistonlu pompaya akuple (4 delikli bağlantı iso) Dişli pompaya akuple 6x6 kaplinli (3 delikli bağlantı uni) Kaplinli (flanşlı bağlantı)	
	Product Number Ürün Numarası Araçlar:VOLVO F 7-F 10-F 86-F 88-F 1233	KT50335 VOLVO R5 - SR 52 TEK DİŞLİ 50910322PO	Seçeceğiniz Pompanın Dönüş yönü,Pto Dönüş Yönü ile Ters Olmalıdır. Milli (şaftlı) veya freze (25x6) çıkışlı. Pistonlu pompaya akuple (4 delikli bağlantı iso) Dişli pompaya akuple 6x6 kaplinli (3 delikli bağlantı uni) Kaplinli (flanşlı bağlantı)
	Product Number Ürün Numarası Araçlar:VOLVO F 7-F 10-F 86-F 88-F 1233	KT50335 VOLVO R5 - SR 52 TEK DİŞLİ 50910322PO	Seçeceğiniz Pompanın Dönüş yönü,Pto Dönüş Yönü ile Ters Olmalıdır. Milli (şaftlı) veya freze (25x6) çıkışlı. Pistonlu pompaya akuple (4 delikli bağlantı iso) Dişli pompaya akuple 6x6 kaplinli (3 delikli bağlantı uni) Kaplinli (flanşlı bağlantı)











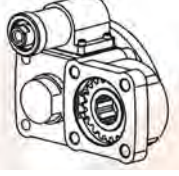

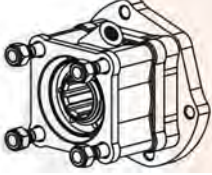
Model / Details

Description

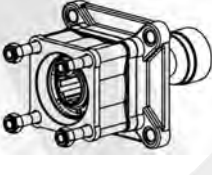
Replaces Ref. No:

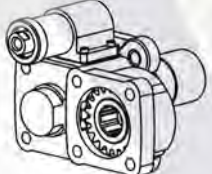
KT No.

Model / Details	Description	Replaces Ref. No:	KT No.
 	Ana Şanzıman:R 51-R / SR 52 / R52 (675 rpm,SOL) Product Number Ürün Numarası Araçlar:VOLVO F 7-F 10-F 86-F 88-F 1233 KT50670 VOLVO R5 - SR 52 ÇİFT DİŞLİ 50910321P0	Ana Şanzıman:R 51-R / SR 52 (675 rpm,SOL) Araçlar:VOLVO F 7-F 10-F 86-F 88-F 1233 Seçeceğiniz Pompanın Dönüş yönü,Pto Dönüş Yönü ile Ters Olmalıdır. Milli (şaftlı) veya freze (25x6) çıkışlı. Pistonlu pompaya akuple (4 delikli bağlantı iso) Dişli pompaya akuple 6x6 kaplinli (3 delikli bağlantı uni) Kaplinli (flanşlı bağlantı)	
 	Ana Şanzıman:R62-SR61-R62 / MR 62 B (780 rpm,SAĞ) Product Number Ürün Numarası Araçlar:F 7-F 10-F 12-F 88-F 89-F 1020-F 1225-N 10-N 12 VOLVO KT50671 VOLVO R6 - R62 TEK DİŞLİ 50911322P0	Ana Şanzıman:R62-SR61-R62 / MR 62 B (780 rpm,SAĞ) Araçlar:F 7-F 10-F 12-F 88-F 89-F 1020-F 1225-N 10-N 12 VOLVO Seçeceğiniz Pompanın Dönüş yönü,Pto Dönüş Yönü ile Ters Olmalıdır. Milli (şaftlı) veya freze (25x6) çıkışlı. Pistonlu pompaya akuple (4 delikli bağlantı iso) Dişli pompaya akuple 6x6 kaplinli (3 delikli bağlantı uni) Kaplinli (flanşlı bağlantı)	
 	Ana Şanzıman:R62-SR61 / MR 62 B (675 rpm,SOL) Product Number Ürün Numarası Araçlar:F 7-F 10-F 12-F 88-F 89-F 1020-F 1225-N 10-N 12 VOLVO KT50672 VOLVO R6 - R 62 ÇİFT DİŞLİ 50911321P0	Ana Şanzıman:R62-SR61 / MR 62 B (675 rpm,SOL) Araçlar:F 7-F 10-F 12-F 88-F 89-F 1020-F 1225-N 10-N 12 VOLVO Seçeceğiniz Pompanın Dönüş yönü,Pto Dönüş Yönü ile Ters Olmalıdır. Milli (şaftlı) veya freze (25x6) çıkışlı. Pistonlu pompaya akuple (4 delikli bağlantı iso) Dişli pompaya akuple 6x6 kaplinli (3 delikli bağlantı uni) Kaplinli (flanşlı bağlantı)	
 	Ana Şanzıman:For GearBox Type SR /R 70 - 72 Product Number Ürün Numarası Araçlar:FL 7- FL 10 - F 12 -N 12-N 10-NL 12 VOLVO KT50673 VOLVO SR/R70-72 TEK DİŞLİ 50912322P0	Ana Şanzıman:For GearBox Type SR /R 70 - 72 Araçlar:FL 7- FL 10 - F 12 -N 12-N 10-NL 12 VOLVO Seçeceğiniz Pompanın Dönüş yönü,Pto Dönüş Yönü ile Ters Olmalıdır. Milli (şaftlı) veya freze (25x6) çıkışlı. Pistonlu pompaya akuple (4 delikli bağlantı iso) Dişli pompaya akuple 6x6 kaplinli (3 delikli bağlantı uni) Kaplinli (flanşlı bağlantı)	
 	Ana Şanzıman:For GearBox Type SR /R 70 - 72 Product Number Ürün Numarası Araçlar:FL 7- FL 10 - F 12 -N 12-N 10-NL 12 VOLVO KT50674 VOLVO SR/R70-72 ÇİFT DİŞLİ 50912321P0	Ana Şanzıman:For GearBox Type SR /R 70 - 72 Araçlar:FL 7- FL 10 - F 12 -N 12-N 10-NL 12 VOLVO Seçeceğiniz Pompanın Dönüş yönü,Pto Dönüş Yönü ile Ters Olmalıdır. Milli (şaftlı) veya freze (25x6) çıkışlı. Pistonlu pompaya akuple (4 delikli bağlantı iso) Dişli pompaya akuple 6x6 kaplinli (3 delikli bağlantı uni) Kaplinli (flanşlı bağlantı)	











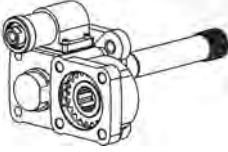

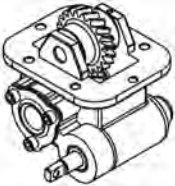
KT No.

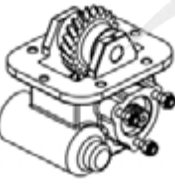

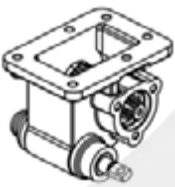

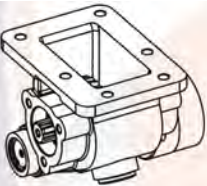



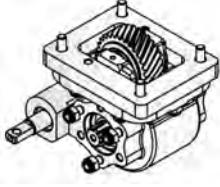

Replaces Ref. No:

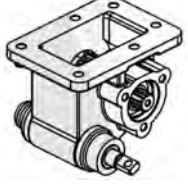
Description

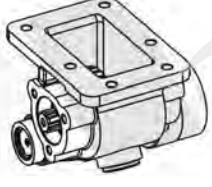
Model / Details

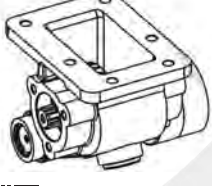
KT No.		Replaces Ref. No:		Description		Model / Details	
 	Ana Şanzıman:SR/R 1000-1400-1700-1900-2000-SRO 2400						
	Product Number Ürün Numarası KT50336 VOLVO R 1400 / 1700 ÇİFT DİŞLİ 50914321P0	Araçlar:FL 10 320-NL 12-FH 16 520-FH 12 420-FM 12-FH 12-FH 16-FM-FM 10 -FM 12 VOLVO FL 616-FL 7-F 10-FL 10-F 12-F 16-N 10-N 12-FL 7-NL 12-F 16 Seçeceğiniz Pompanın Dönüş yönü,Pto Dönüş Yönü ile Ters Olmalıdır. Milli (şaftlı) veya freze (25x6) çıkışlı. Pistonlu pompaya akuple (4 delikli bağlantı iso) Dişli pompaya akuple 6x6 kaplinli (3 delikli bağlantı uni) Kaplinli (flanşlı bağlantı)					
HUNDAI P.T.O.							
 	Ana Şanzıman:						
	Product Number Ürün Numarası KT50337 HYUNDAI HD 120 MEKANİK 51216512M0	Araçlar:HD 120 / HD 65 / HD 72 / HD 78 Seçeceğiniz Pompanın Dönüş yönü,Pto Dönüş Yönü ile Ters Olmalıdır. Milli (şaftlı) veya freze (25x6) çıkışlı. Pistonlu pompaya akuple (4 delikli bağlantı iso) Dişli pompaya akuple 6x6 kaplinli (3 delikli bağlantı uni) Kaplinli (flanşlı bağlantı)					
 	Ana Şanzıman:						
	Product Number Ürün Numarası KT50338 HYUNDAI HD 120 PNÖMATİK 51216512P0	Araçlar:HD 120 / HD 65 / HD 72 / HD 78 Seçeceğiniz Pompanın Dönüş yönü,Pto Dönüş Yönü ile Ters Olmalıdır. Milli (şaftlı) veya freze (25x6) çıkışlı. Pistonlu pompaya akuple (4 delikli bağlantı iso) Dişli pompaya akuple 6x6 kaplinli (3 delikli bağlantı uni) Kaplinli (flanşlı bağlantı)					
 	Ana Şanzıman:M1S5 - M2S5 - M3S5 -(4,444-5,494,53886-5,181)						
	Product Number Ürün Numarası KT50339 HYUNDAI HD 35 MEKANİK 51210512M0	Araçlar:H 350 / 3F 412 / HD50-72-77 HYUNDAI / Hd65 /03R04495 / 03R04499 / 03R04493 / Hd35 / HT 102T0033 Seçeceğiniz Pompanın Dönüş yönü,Pto Dönüş Yönü ile Ters Olmalıdır. Milli (şaftlı) veya freze (25x6) çıkışlı. Pistonlu pompaya akuple (4 delikli bağlantı iso) Dişli pompaya akuple 6x6 kaplinli (3 delikli bağlantı uni) Kaplinli (flanşlı bağlantı)					
 	Ana Şanzıman:M1S5 - M2S5 - M3S5 -(4,444-5,494,53886-5,181)						
	Product Number Ürün Numarası KT50340 HYUNDAI HD 35 VAKUMLU 51210512V0	Araçlar:H 350 / 3F 412 / HD50-72-77 HYUNDAI / Hd65 /03R04495 / 03R04499 / 03R04493 / Hd35 / HT 102T00336 Seçeceğiniz Pompanın Dönüş yönü,Pto Dönüş Yönü ile Ters Olmalıdır. Milli (şaftlı) veya freze (25x6) çıkışlı. Pistonlu pompaya akuple (4 delikli bağlantı iso) Dişli pompaya akuple 6x6 kaplinli (3 delikli bağlantı uni) Kaplinli (flanşlı bağlantı)					

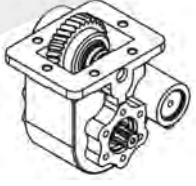

Model / Details	Description	Replaces Ref. No:	KT No.
 	Ana Şanzıman: Product Number Ürün Numarası Araçlar:HD 75 HYUNDAI KT50675 HYUNDAI HD 45 MEKANİK 51211512M0	Seçeceğiniz Pompanın Dönüş yönü,Pto Dönüş Yönü ile Ters Olmalıdır. Milli (şaftlı) veya freze (25x6) çıkışlı. Pistonlu pompaya akuple (4 delikli bağlantı iso) Dişli pompaya akuple 6x6 kaplinli (3 delikli bağlantı uni) Kaplinli (flanşlı bağlantı)	
 	Ana Şanzıman:HD105 S106 853 / 105 S106 853 /105 S1925 Product Number Ürün Numarası Araçlar:HD 75 KARSAN - HD 72 EURO2 KT50676 HYUNDAI HD 75 MEKANİK 51213512M0	Seçeceğiniz Pompanın Dönüş yönü,Pto Dönüş Yönü ile Ters Olmalıdır. Milli (şaftlı) veya freze (25x6) çıkışlı. Pistonlu pompaya akuple (4 delikli bağlantı iso) Dişli pompaya akuple 6x6 kaplinli (3 delikli bağlantı uni) Kaplinli (flanşlı bağlantı)	
 	Ana Şanzıman:HD105 S106 853 / 105 S106 853 /105 S1925 Product Number Ürün Numarası Araçlar:HD 75 KARSAN - HD 72 EURO2 KT50677 HYUNDAI HD 75 VAKUMLU 51213512V0	Seçeceğiniz Pompanın Dönüş yönü,Pto Dönüş Yönü ile Ters Olmalıdır. Milli (şaftlı) veya freze (25x6) çıkışlı. Pistonlu pompaya akuple (4 delikli bağlantı iso) Dişli pompaya akuple 6x6 kaplinli (3 delikli bağlantı uni) Kaplinli (flanşlı bağlantı)	
 	Ana Şanzıman:HD105W02132 (5 VİTES) / 5 S 21187 Product Number Ürün Numarası Araçlar:HD 75 / HD 35 EURO 4 / 75 EURO 4 (5 VİTES) KT50678 HYUNDAI HD 75 EURO 4 (5 VİTES) VAKUMLU 51214512V0	Seçeceğiniz Pompanın Dönüş yönü,Pto Dönüş Yönü ile Ters Olmalıdır. Milli (şaftlı) veya freze (25x6) çıkışlı. Pistonlu pompaya akuple (4 delikli bağlantı iso) Dişli pompaya akuple 6x6 kaplinli (3 delikli bağlantı uni) Kaplinli (flanşlı bağlantı)	
 	Ana Şanzıman:T0 60S6 / 60S5 Product Number Ürün Numarası Araçlar:HD 75 EURO4/ F 150/F160 KT50679 HYUNDAI HD 75 EURO 4 (6 VİTES) VAKUMLU 51215512V0	Seçeceğiniz Pompanın Dönüş yönü,Pto Dönüş Yönü ile Ters Olmalıdır. Milli (şaftlı) veya freze (25x6) çıkışlı. Pistonlu pompaya akuple (4 delikli bağlantı iso) Dişli pompaya akuple 6x6 kaplinli (3 delikli bağlantı uni) Kaplinli (flanşlı bağlantı)	





KT No.



Replaces Ref. No:

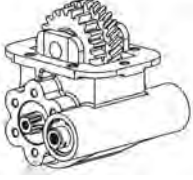

Description

Model / Details

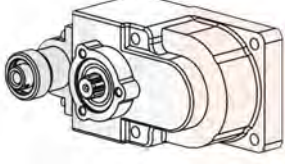
TURNER P.T.O.

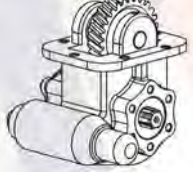

 	Ana Şanzıman:TURNER-SPICER-T5A 2801-2803-2811-3016-3017-3047	
	Product Number Ürün Numarası	Araçlar:1340-1840 BMC-140 BMC-AS600-BEDFORD-1210-1212-1312 FORD / 66-83/FREIGHTER 302 LEYLAND
	KT50341	Seçeceğiniz Pompanın Dönüş yönü,Pto Dönüş Yönü ile Ters Olmalıdır.
	TURNER 3017 PNÖMATİK 51011512P0	Milli (şaftlı) veya freze (25x6) çıkışlı. Pistonlu pompaya akuple (4 delikli bağlantı iso) Dişli pompaya akuple 6x6 kaplinli (3 delikli bağlantı uni) Kaplinli (flanşlı bağlantı)

 	Ana Şanzıman:TURNER-SPICER T5 C 4001-4058-4060-4068-4084 R-L	
	Product Number Ürün Numarası	Araçlar:162.22-162.25-170.25 FATİH / YAVUZ 1850-2200 / 700-800-900 DODGE DODGE-1210 FORD
	KT50342	Seçeceğiniz Pompanın Dönüş yönü,Pto Dönüş Yönü ile Ters Olmalıdır.
	TURNER T5C4060 K 51012311P0	Milli (şaftlı) veya freze (25x6) çıkışlı. Pistonlu pompaya akuple (4 delikli bağlantı iso) Dişli pompaya akuple 6x6 kaplinli (3 delikli bağlantı uni) Kaplinli (flanşlı bağlantı)

 	Ana Şanzıman:TURNER-SPICER T5 C 4001-4058-4060-4068-4084 R-L	
	Product Number Ürün Numarası	Araçlar:162.22-162.25-170.25 FATİH / YAVUZ 1850-2200 / 700-800-900 DODGE SUPER 900 DODGE-1210 FORD
	KT50343	Seçeceğiniz Pompanın Dönüş yönü,Pto Dönüş Yönü ile Ters Olmalıdır.
	TURNER T5C4060 Y 51013511P0	Milli (şaftlı) veya freze (25x6) çıkışlı. Pistonlu pompaya akuple (4 delikli bağlantı iso) Dişli pompaya akuple 6x6 kaplinli (3 delikli bağlantı uni) Kaplinli (flanşlı bağlantı)



 	Ana Şanzıman:3053A	
	Product Number Ürün Numarası	Araçlar:REO ASKERİ ARAÇ
	KT50344	Seçeceğiniz Pompanın Dönüş yönü,Pto Dönüş Yönü ile Ters Olmalıdır.
	SPICER DANA 3053A 51010511P0	Milli (şaftlı) veya freze (25x6) çıkışlı. Pistonlu pompaya akuple (4 delikli bağlantı iso) Dişli pompaya akuple 6x6 kaplinli (3 delikli bağlantı uni) Kaplinli (flanşlı bağlantı)

JAC P.T.O.

 	Ana Şanzıman: LC6T55	
	Product Number Ürün Numarası	Seçeceğiniz Pompanın Dönüş yönü,Pto Dönüş Yönü ile Ters Olmalıdır. Milli (şaftlı) veya freze (25x6) çıkışlı.
	KT50345	Seçeceğiniz Pompanın Dönüş yönü,Pto Dönüş Yönü ile Ters Olmalıdır.
	JAC PK 52110512P0	Milli (şaftlı) veya freze (25x6) çıkışlı. Pistonlu pompaya akuple (4 delikli bağlantı iso) Dişli pompaya akuple 6x6 kaplinli (3 delikli bağlantı uni) Kaplinli (flanşlı bağlantı)



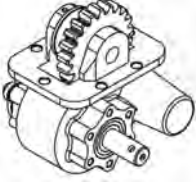



MACK P.T.O.

 	Ana Şanzıman:DM 600-227589-281KB565-284KB5159A MACK	
	Product Number Ürün Numarası	Araçlar:MACK DM 600-DM 611 S 6296
KT50680	Seçeceğiniz Pompanın Dönüş yönü,Pto Dönüş Yönü ile Ters Olmalıdır.	
MACK 1	Milli (şaftlı) veya freze (25x6) çıkışlı.	
51111542P0	Pistonlu pompaya akuple (4 delikli bağlantı iso)	
	Dişli pompaya akuple 6x6 kaplinli (3 delikli bağlantı uni)	
	Kaplinli (flanşlı bağlantı)	

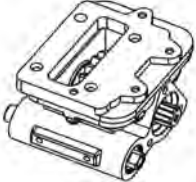

 	Ana Şanzıman:TRL-TRDL-TRXL-TRDXL-DX-DM 686-107-1070-1071-1075	
	Product Number Ürün Numarası	Araçlar:MACK DM 686-868ST-SX-F700-F712-F786-F795
KT50681	Seçeceğiniz Pompanın Dönüş yönü,Pto Dönüş Yönü ile Ters Olmalıdır.	
MACK 2	Milli (şaftlı) veya freze (25x6) çıkışlı.	
51110541P0	Pistonlu pompaya akuple (4 delikli bağlantı iso)	
	Dişli pompaya akuple 6x6 kaplinli (3 delikli bağlantı uni)	
	Kaplinli (flanşlı bağlantı)	

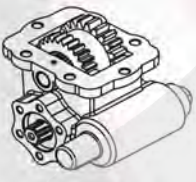
NISSAN P.T.O.

 	Ana Şanzıman:NISSANUD60 51712512P0	
	Product Number Ürün Numarası	Araçlar: NISSAN UD60, BMC 415
KT50682	Seçeceğiniz Pompanın Dönüş yönü,Pto Dönüş Yönü ile Ters Olmalıdır.	
NISSAN UD60	Milli (şaftlı) veya freze (25x6) çıkışlı.	
51712512P0	Pistonlu pompaya akuple (4 delikli bağlantı iso)	
	Dişli pompaya akuple 6x6 kaplinli (3 delikli bağlantı uni)	
	Kaplinli (flanşlı bağlantı)	

 	Product Number Ürün Numarası	Araçlar:NISSAN UD95
	KT50683	Seçeceğiniz Pompanın Dönüş yönü,Pto Dönüş Yönü ile Ters Olmalıdır.
NISSAN UD780	Milli (şaftlı) veya freze (25x6) çıkışlı.	
51714512P0	Pistonlu pompaya akuple (4 delikli bağlantı iso)	
	Dişli pompaya akuple 6x6 kaplinli (3 delikli bağlantı uni)	
	Kaplinli (flanşlı bağlantı)	

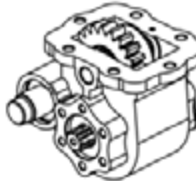
KAMAZ P.T.O.

 	Ana Şanzıman: 33104 -33106 -1700010	
	Product Number Ürün Numarası	Araçlar:GAZ-KAMAZ
KT50684	Seçeceğiniz Pompanın Dönüş yönü,Pto Dönüş Yönü ile Ters Olmalıdır.	
KAMAZ PK	Milli (şaftlı) veya freze (25x6) çıkışlı.	
52010511P0	Pistonlu pompaya akuple (4 delikli bağlantı iso)	
	Milli (şaftlı) veya freze (25x6) çıkışlı.	
	Kaplinli (flanşlı bağlantı)	





KT No.



Replaces Ref. No:

Description

Model / Details

RENAULT P.T.O.

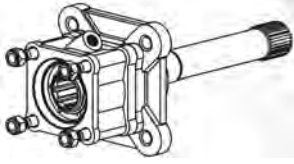
Ana Şanzıman: B9 / B18 / B18200 L 42	
 	Product Number Ürün Numarası Araçlar:RENAULT (R.V.I)G340TI MAXTER 280-340-385-400 PREMIUM 430-470 MAGNUM INTEGRAL
KT50346	Seçeceğiniz Pompanın Dönüş yönü,Pto Dönüş Yönü ile Ters Olmalıdır.
RENAULT B9 / B18 51810522P0	Milli (şaftlı) veya freze (25x6) çıkışlı. Pistonlu pompaya akuple (4 delikli bağlantı iso) Dişli pompaya akuple 6x6 kaplinli (3 delikli bağlantı uni) Kaplinli (flanşlı bağlantı)

Ana Şanzıman: AT 2412 D	
 	Product Number Ürün Numarası Araçlar:RENAULT PREMIUM OPTIDRIVER 430DXI - 440DXI
KT50347	Seçeceğiniz Pompanın Dönüş yönü,Pto Dönüş Yönü ile Ters Olmalıdır.
RENAULT PREMIUM 51811322P0	Milli (şaftlı) veya freze (25x6) çıkışlı. Pistonlu pompaya akuple (4 delikli bağlantı iso) Dişli pompaya akuple 6x6 kaplinli (3 delikli bağlantı uni) Kaplinli (flanşlı bağlantı)



Model / Details

Description

Replaces Ref. No:

KT No.

MERCEDES KARDAN MİLLERİ		
	Product Number Ürün Numarası	Product Name Ürün Adı
	KT50685	ACTROS ŞANZIMAN (27.5CM)
	KT50686	ACTROS ŞANZIMAN (25.2CM)
	KT50687	G3-65-90 UNIMOG
ZF KARDAN MİLLERİ		
	Product Number Ürün Numarası	Product Name Ürün Adı
	KT50688	ZF 9 S 75 KARDAN MİLİ
	KT50689	(ZF 9-S 109) RT 12 91
	KT50690	(ZF 9-S 109) RT 12 92
	KT50691	(ZF 16 S 109) R13,53
	KT50692	ZF 16 K 130 KARDAN MİLİ
	KT50693	ZF 16 K 160 KARDAN MİLİ
	KT50694	TGA İNTARDER PLATELİ 250mm
	KT50695	TGA İNTARDER PLATELİ 285mm
	KT50696	ASTRONİK UZUN PLATELİ 285mm
	KT50697	ASTRONİK UZUN PLATELİ 300mm
	KT50698	ASTRONİK KISA 250mm
	KT50699	ZF 16 S 151 KARDAN MİLİ
	KT50700	ZF 5S111 KARDAN MİLİ602151
	KT50701	TGA OTOMATİK PLATELİ 250mm
	KT50702	ASTRONİK OTOMATİK PLATELİ 285mm
	KT50703	ASTRONİK OTOMATİK ORJİNAL PLATELİ 285mm
SCANIA KARDAN MİLLERİ		
	Product Number Ürün Numarası	Product Name Ürün Adı
	KT50704	SCANIA GRS905 KARDAN MİLİ UZUN 605mm
	KT50705	SCANIA GRS 905 KARDAN MİLİ KISA 510 mm

HEMA KARDAN MİLLERİ		
	Product Number Ürün Numarası	Product Name Ürün Adı
	KT50348	4106 KARDAN MİLİ
	KT50349	6019 - 8209 KARDAN MİLİ
	KT50350	6109 - 8209 ESKİ TİP KAR. MİLİ
FULLER KARDAN MİLLERİ		
	Product Number Ürün Numarası	Product Name Ürün Adı
	KT50351	FULLER 17316 KARDAN MİLİ
	KT50352	FULLER 15612-11612 KARDAN MİLİ
VOLVO KARDAN MİLLERİ		
	Product Number Ürün Numarası	Product Name Ürün Adı
	KT50353	VOLVO SR 1700 KARDAN MİLİ UZUN
	KT50354	VOLVO SR 1700 KARDAN MİLİ KISA
IVECO KARDAN MİLLERİ		
	Product Number Ürün Numarası	Product Name Ürün Adı
	KT50355	IVECO 2846.5 KARDAN MİLİ
	KT50356	IVECO 2870.9 KARDAN MİLİ
	KT50357	IVECO 2895.9 KARDAN MİLİ



YÖN DENETİM VALF ÇEŞİTLERİ

	Product Number Ürün Numarası	Product Name Ürün Adı
	KT50706	3/4" PNÖMATİK YÖN VENTİLİ
	KT50707	1" DÜZ RAKORLU PNÖMATİK YÖN VENTİLİ
	KT50708	1" TERS RAKORLU PNÖMATİK YÖN VENTİLİ
	KT50709	TANK TİPİ KAPALI DEVRE 3/4" YÖN VENTİLİ
	KT50710	TANK TİPİ KAPALI 1" DÜZ RAKORLU YÖN VENTİLİ
	KT50711	TANK TİPİ KAPALI 1" TERS RAKORLU YÖN VENTİLİ
	KT50712	AÇIK DEVRE 1" 3B YÖN VENTİLİ
	KT50713	AÇIK DEVRE 1" 3B YÖN VENTİLİ KÖRÜKLÜ
	KT50714	AÇIK DEVRE 1" 4B YÖN VENTİLİ
	KT50715	AÇIK DEVRE 1" TANK TİPİ 4B YÖN VENTİLİ
	KT50716	VAKUMLU VENTİL 1" YÖN VENTİLİ
	KT50717	VAKUMLU VENTİL 3/4" YÖN VENTİLİ
	KT50718	AÇIK DEVRE VAKUMLU VENTİL 3/4" YÖN VENTİLİ
	KT50719	AÇIK DEVRE VAKUMLU VENTİL 1" YÖN VENTİLİ
	KT50720	2 ÇIKIŞLI 1" RÖMORK VENTİLİ YÖN VENTİLİ
	KT50721	1" RÖMORK VENTİLİ LİBYA
	KT50722	TEK KONTROLLÜ YÖN VENTİLİ 1" YÖN VENTİLİ
	KT50723	BASINÇ KONTROLLÜ RÖMORK VENTİLİ YÖN VENTİLİ
	KT50724	AÇIK DEVRE 1"180 LT (ALİMİNYUM GÖVDE)
	KT50725	3/4" MEKANİK YÖN VENTİLİ
	KT50726	1" DÜZ RAKORLU MEKANİK YÖN VENTİLİ
	KT50727	1" TERS RAKORLU MEKANİK YÖN VENTİLİ

BAĞLANTI EKİPMANLARI

	Product Number Ürün Numarası	Product Name Ürün Adı
	KT50728	UNI ADAPTÖRÜ 3 BAĞLANTIDAN 4 BAĞLANTIYA
	KT50729	ISO ADAPTÖRÜ 4 BAĞLANTIDAN 3 BAĞLANTIYA
	KT50730	ISO ADAPTÖRÜ 4 BAĞLANTIDAN 3 BAĞLANTIYA FLANŞLI
	KT50731	AKTARMALI ADAPTÖRÜ
	KT50732	AKTARMALI ADAPTÖRÜ FLANŞLI
	KT50733	UZATMA ADAPTÖRÜ RULMANLI
	KT50734	UZATMA ADAPTÖRÜ RULMANSIZ
	KT50735	UZATMA ADAPTÖRÜ RULMANLI KISA
	KT50736	SAE B ISO PTO ADAPTÖRÜ
	KT50737	SAE B POMPA UNI PTO ADAPTÖRÜ
	KT50738	UNIMOG PTO ADAPTÖRÜ
	KT50739	FULLER ARA APARTMAN
	KT50740	6*6 DIŞLI POMPA KAPLINİ
	KT50741	6*8 ELEMANLI POMPA KAPLINİ
	KT50742	6 FREZELİ 1120 FLANŞ
	KT50743	6 FREZELİ 1300 FLANŞ
	KT50744	8 FREZELİ 1120 FLANŞ
	KT50745	8 FREZELİ 1300 FLANŞ
	KT50746	6 FREZE 30 LUK FLANŞ
	KT50747	30 LUK KAMALI FLANŞ
KT50748	KAMALI ADAPTÖR PTO FLANŞI	

SINIR KONTROL VALF ÇEŞİTLERİ

	Product Number Ürün Numarası	Product Name Ürün Adı
	KT50749	3/4" KAPALI DEVRE SINIR KONTROL
	KT50750	1" KAPALI DEVRE SINIR KONTROL
	KT50751	3/4" AÇIK DEVRE SINIR KONTROL
	KT50752	1" AÇIK DEVRE SINIR KONTROL
	KT50753	1" RAKORLU ÇEKME Lİ SINIR VENTİLİ LİBYA
	KT50754	PNÖMATİK KONTROLLÜ SINIR VALFİ
	KT50755	TRAKTÖR RÖMORK SINIR VENTİLİ

TRUCK SPARE PARTS

Gesuchte Europäische Qualität

HYDRAULIC sought-after
quality

HYDRAULIC VALVES



KLÖTZE
TECHNIC

www.klotzetechnik.de

Klötze Technic ist ein in Deutschland ansässiger Hersteller und Lieferant von LKW-, Anhänger- und Bus-Ersatzteilen.



KLÖTZE
TECHNIC

Gesuchte Europäische
Qualität

Klötze Technic is a Germany-based company specializing in truck, trailer, and bus spare parts. Together with our sales office in Turkey, we provide our customers with original spare parts of guaranteed quality. Our products are manufactured with superior German engineering.

Our main groups consist of Engine, Cooling System, Fuel System, Exhaust System, Clutch & Pedal, Gearbox, Propeller Shaft, Axles, Brake System, Hubs & Wheels, Suspension, Steering, Electrical System, Cabin, and Body.

At Klötze Technic, we strive to provide our customers with the highest quality products, competitive prices, and superior customer service.

Our Mission:

At Klötze Technic, we work to provide our customers with the highest quality and reliable spare parts for trucks, trailers, and buses.

Our high-quality products are manufactured with superior German engineering.

Our mission is to meet our customers' needs and provide them with the best customer service possible.

Our Vision:

At Klötze Technic, we aim to become a world-leading company in the field of truck, trailer, and bus spare parts.

Our vision is to provide our customers with the highest quality products, competitive prices, and superior customer service. In doing so, we aim to meet our customers' needs and ensure their satisfaction.

Our Quality Policy:

At Klötze Technic, quality and customer satisfaction are always our top priorities. Our products are manufactured with superior German engineering and are provided to our customers as original spare parts of guaranteed quality. Our quality policy is to provide our customers with the best quality products and meet their needs in the best way possible.

Customer satisfaction is always important to us.

TRUCK SPARE PARTS



KLÖTZE
TECHNIC

Gesuchte Europäische
Qualität



TRUCK SPARE PARTS

www.klotzetechnik.de

İÇİNDEKİLER // INDEX

HİDROLİK İKİZ KİLİTLEME VALFLERİ
DOUBLE PILOT OPERATED CHECK VALVES

HİDROLİK HAT TİPİ İKİZ KİLİTLEME VALFLERİ
DOUBLE ACTING PILOT OPERATED CHECK VALVES

HİDROLİK TEKLİ YÜK TUTMA VALFLERİ
SINGLE OVERCENTRE VALVES

HİDROLİK ÇİFTLİ YÜK TUTMA VALFLERİ
DOUBLE OVERCENTRE VALVES

HİDROLİK BASINÇ EMNİYET VALFLERİ
HYDRAULIC RELIEF VALVES

HİDROLİK BASINÇ EMNİYET VALF KATRIÇLERİ
HYDRAULIC RELIEF VALVES CARTIDGE

NG06 VALF PLEYTLERİ
NG06 VALVE PLATES

AKIŞ BÖLÜCÜ
FLOW DIVIDER

KOMBİNASYONLU BASINÇ SIRALAMA VALFLERİ
HYDRAULIC COMBİNEĐ SEQUENCE VALVES

ÇİFT ETKİLİ KOMBİNASYONLU BASINÇ SIRALAMA VALFLERİ
DOUBLE EFFECT HYDRAULIC COMBİNEĐ SEQUENCE VALVES

KÖRLEME TAPALARI
SEALING PLUGS

HİDROLİK İKİ YOLLU KÜRESEL VANA
HYDRAULIC TWO WAY BALL VALVES

HİDROLİK ÜÇ YOLLU L TİPİ KÜRESEL VANA
HYDRAULIC THREE WAY L TYPE BALL VALVES

HİDROLİK ÜÇ YOLLU VANA
HYDRAULIC THREE WAY FLOW DIVIDER

HİDROLİK DÖRT YOLLU VANA
HYDRAULIC FOUR WAY FLOW DIVIDER

T HATTI KÜRESEL VANALI İKİZ KİLİTLEME VALFİ
T PORT BALL VALF DOUBLE PILOT OPERATED CHECK VALVE

HİDROLİK ALTI YOLLU VANA
HYDRAULIC SIX WAY FLOW DIVIDER

HİDROLİK DÖKÜM ALTI YOLLU VANA
HYDRAULIC CASTING SIX WAY FLOW DIVIDER

HİDROLİK ÇİFT İKİZ KİLİTLEME VALFLİ MONO BLOK ALTI YOLLU VANA
HYDRAULIC SIX FLOW DIVIDER WITH DOUBLE PILOT OPERATED CHECK VALVE MONOBLOCK



HİDROLİK İKİZ KİLİTLEME VALFLERİ

İkiz kilitleme valfleri silindirler üzerinde her iki yöne olan akışı kapatmak için kullanılırlar. Bir yönden gelen akış pilot basıncına ulaşınca kadar diğer yöndeki akışı engeller. Silindirin stabil konumda kalmasını sağlar.

Malzeme	Otomat Çeliği
Diş Ölçüsü	BSP, Metrik
Sızdırmazlık Elemanı	Nitril O-ring (NBR)
Çalışma Sıcaklığı	-30°C ile 110°C Arası
Kaplama	Galvaniz + Cr+3
Isıl İşlem	Sementasyon (İç Parçalarda)
Kullanım Alanı	Kaldırma ekipmanları, vinç ve tarım makinaları

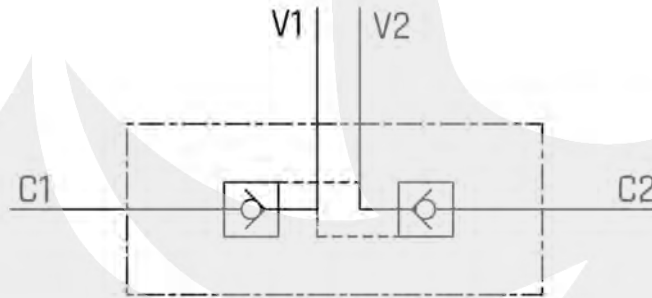

DOUBLE PILOT OPERATED CHECK VALVES

Twin locking valves are used to close the flow in both directions on the cylinders. The flow from one side blocks the flow to the other until the pilot pressure is reached. It allows the cylinder to stay in the stable position.

Material	Free Cutting Stell
Thread Size	BSP, Metric
Sealing Element	Nitril O-ring (NBR)
Working Temperature	-30°C and 110°C
Plating	Zinc Plated + Cr+3
Heat Treatment	Case Hardened (Internal Parts)
Application	Lifting equipments, Cranes and Agricultural Machines

Stok Kodu Stock Code	Diş Ölçüsü Thread Size	Maksimum Akış Max Flow Debi lt/dk	Maksimum Basınç Max Pressure Pmax Bar	Pilot Oranı Pilot Ratio	Açma Basıncı Cracking Pressure Bar
KTCV0001401	1/4"	47	380	1:4	4
KTCV0003801	3/8"	47	380	1:4	6
KTCV003802*	3/8"*	47	380	1:4	6
KTCV0001201	1/2"	63	360	1:4	8
KTCV0001801	M18x1.5"	47	380	1:4	6

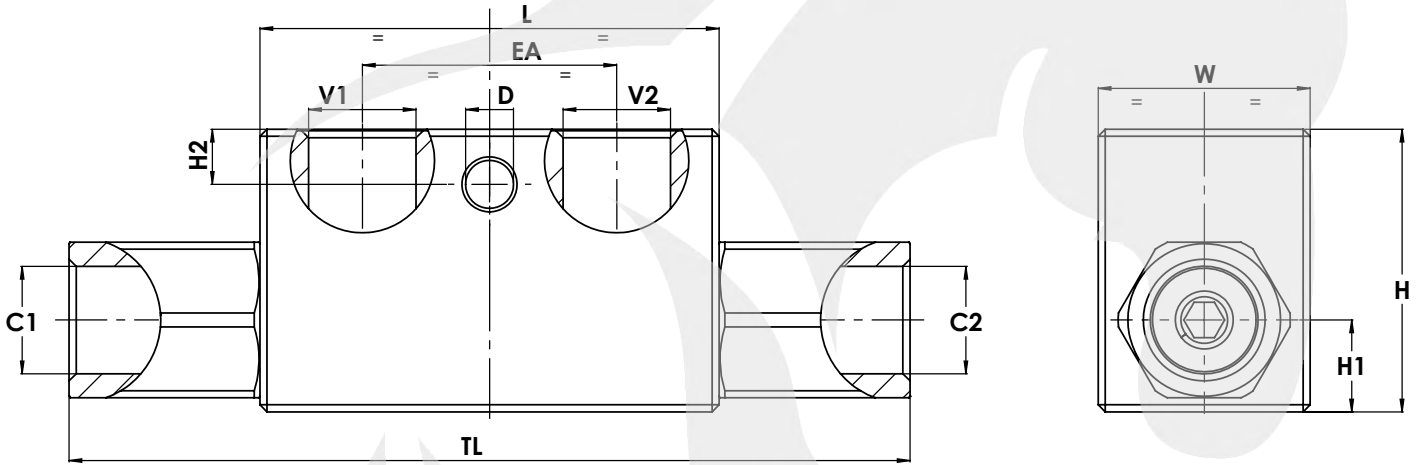

Diş Ölçüsü
Thread Size

Ölçüler
Dimensions - mm

C1-C2 / V1-V2	EA	L	TL	W	H	H1	H2	ØD
1/4"	36	65	128	30	40	13	7,8	7
3/8"	36	65	128	30	40	13	7,8	7
3/8"*	36	65	138	30	40	13	7,8	7
1/2"	42	80	165	30	50	15	10	8,5
M18x1.5"	36	65	128	30	40	13	7,8	7

* SOMUNLU / BANJO

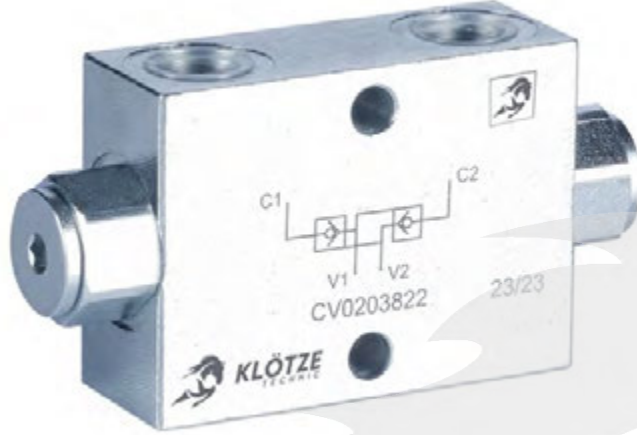

HİDROLİK HAT TİPİ İKİZ KİLİTLEME VALFLERİ

Hat tipi ikiz kilitleme valfleri silindirler üzerinde her iki yöne olan akışı kapatmak için kullanılırlar. Bir yönden gelen akış pilot basıncına ulaşıncaya kadar diğer yöndeki akışı engeller. Silindirin stabil konumda kalmasını sağlar.

Malzeme	Otomat Çeliği
Diş Ölçüsü	BSP, Metrik
Sızdırmazlık Elemanı	Nitril O-ring (NBR)
Çalışma Sıcaklığı	-30°C ile 110°C Arası
Kaplama	Galvaniz + Cr+3
Isıl İşlem	Sementasyon (İç Parçalarda)
Kullanım Alanı	Kaldırma ekipmanları, vinç ve tarım makinaları

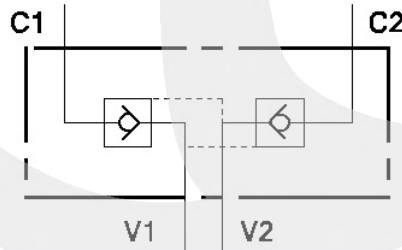

DOUBLE ACTING PILOT OPERATED CHECK VALVES

Pilot check valves are used to block the cylinder in both directions. Flow is free in one direction and blocked in the reverse direction until pilot pressure is applied.

Material	Free Cutting Stell
Thread Size	BSP, Metric
Sealing Element	Nitril O-ring (NBR)
Working Temperature	-30°C and 110°C
Plating	Zinc Plated + Cr+3
Heat Treatment	Case Hardened (Internal Parts)
Application	Lifting equipments, Cranes and Agricultural Machines

Stok Kodu Stock Code	Diş Ölçüsü Thread Size	Maksimum Akış Max Flow Debi lt/dk	Maksimum Basınç Max Pressure Pmax Bar	Pilot Oranı Pilot Ratio	Açma Basıncı Cracking Pressure Bar
KTCV0203822	3/8"	30	350	1:5,5	4,5

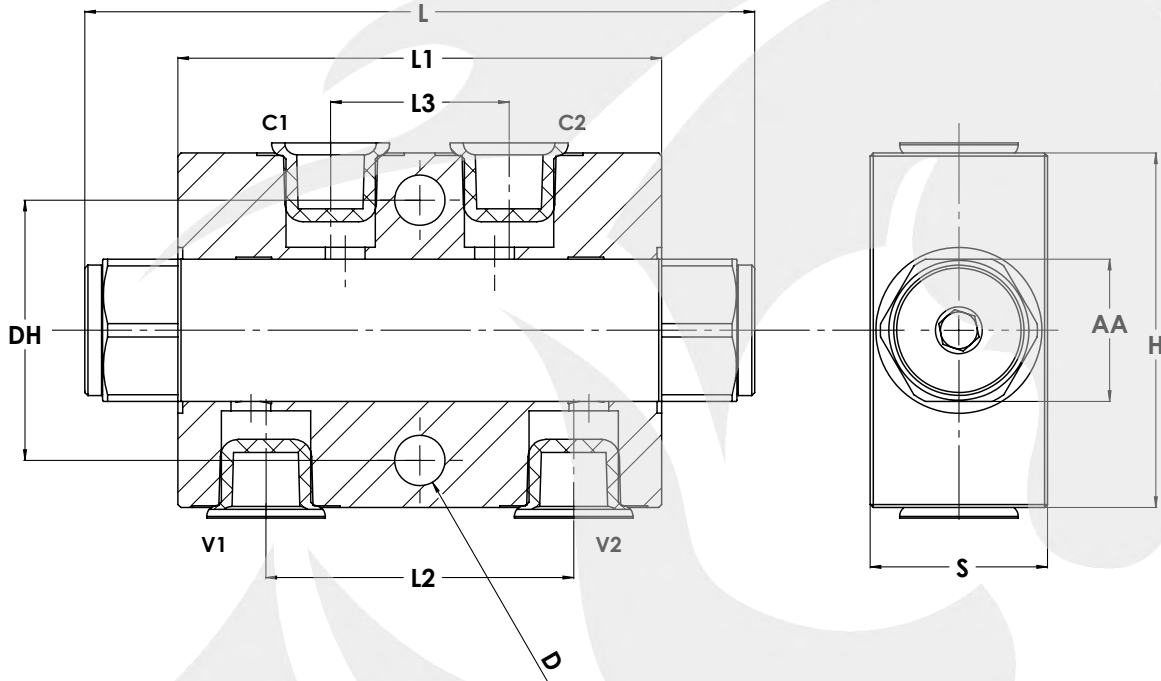

Diş Ölçüsü
Thread Size

Ölçüler
Dimensions - mm

C1-C2 / V1-V2	L	L1	L2	L3	DH	S	H	AA	ØD
3/8"	113	81,5	52	30	44	30	60	24	8,5



HİDROLİK TEKLİ YÜK TUTMA VALFLERİ

Yükün, yön kontrol valfi orta konumdayken istenmeyen bir şekilde inmesini engeller. Kapalı merkezli valf kullanıldığında, sürgü ile gövde arasındaki kaçakları tolere eder. Yükün kontrolsüz hareketini ve aktüatörlerde kavitasyon oluşumunu önler, böylece yükü düzenler. Hortum patlaması gibi acil durumlarda yükün kontrolsüz hareketini engeller. Tek yönde yük kontrolünü hassas bir şekilde sağlar.

SINGLE OVERCENTRE VALVES

These valves are used to control the actuator movements and block in one direction. In order to have the descent of a load under control and avoid the load's weight being carried away the valve will prevent any cavitation of the actuator. Single overcentre valves is different due to the connection positions and the pilot ratio.

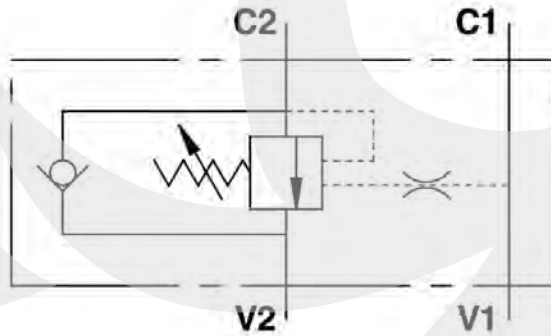

Malzeme	Otomat Çeliği
Diş Ölçüsü	BSP, Metrik
Sızdırmazlık Elemanı	Nitril O-ring (NBR)
Çalışma Sıcaklığı	-30°C ile 110°C Arası
Kaplama	Galvaniz + Cr+3
Isıl İşlem	Sementasyon (İç Parçalarda)
Kullanım Alanı	Kaldırma ekipmanları, vinç ve tarım makinaları

Material	Free Cutting Stell
Thread Size	BSP, Metric
Sealing Element	Nitril O-ring (NBR)
Working Temperature	-30°C and 110°C
Plating	Zinc Plated + Cr+3
Heat Treatment	Case Hardened (Internal Parts)
Application	Lifting equipments, Cranes and Agricultural Machines

Stok Kodu Stock Code	Diş Ölçüsü Thread Size	Maksimum Akış Max Flow Debi lt/dk	Maksimum Basınç Max Pressure Pmax Bar	Pilot Oranı Pilot Ratio
KTOC0103801	3/8"	40	350	1:4,5

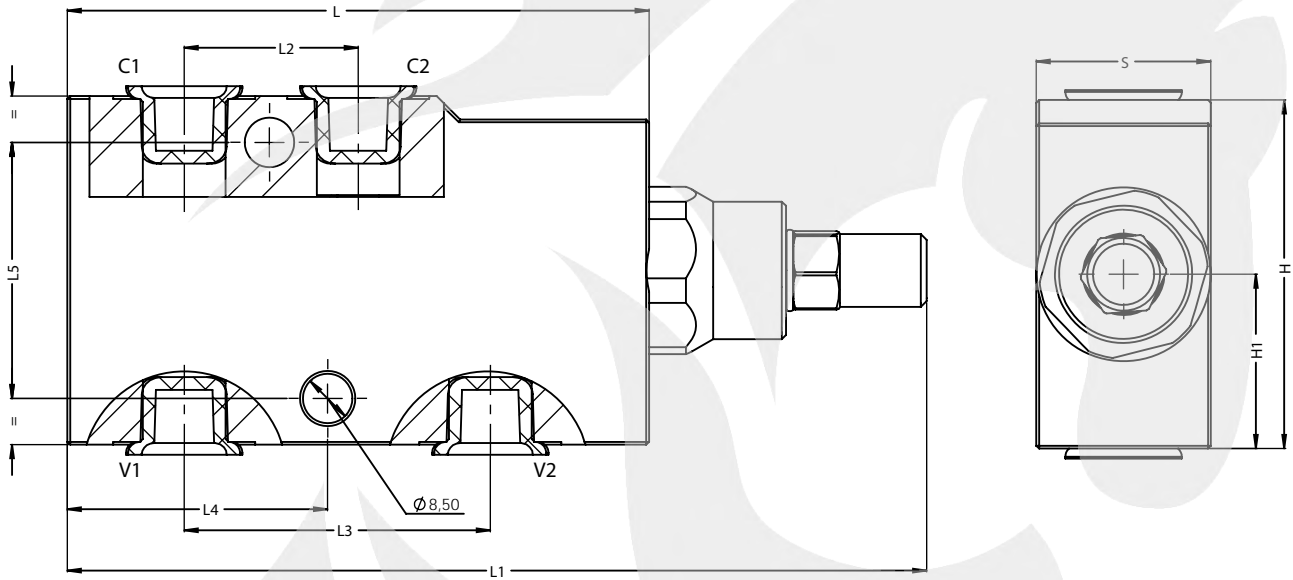

Diş Ölçüsü
Thread Size

Ölçüler
Dimensions - mm

C1-C2 / V1-V2	L	L1	L2	L3	L4	L5	S	H	H1	ØD
3/8"	100	147,70	29,90	52,60	44,75	44	30	60	30	8,5



HİDROLİK ÇİFTLİ YÜK TUTMA VALFLERİ

Yükün, yön kontrol valfi orta konumdayken istenmeyen bir şekilde inmesini engeller. Kapalı merkezli valf kullanıldığında, sürgü ile gövde arasındaki kaçaqları tolere eder. Yükün kontrolsüz hareketini ve aktüatörlerde kavitasyon oluşumunu önler, böylece yükü düzenler. Hortum patlaması gibi acil durumlarda yükün kontrolsüz hareketini engeller. Çift yönde yük kontrolünü hassas bir şekilde sağlar.

Malzeme	Otomat Çeliği
Diş Ölçüsü	BSP, Metrik
Sızdırmazlık Elemanı	Nitril O-ring (NBR)
Çalışma Sıcaklığı	-30°C ile 110°C Arası
Kaplama	Galvaniz + Cr+3
Isıl İşlem	Sementasyon (İç Parçalarda)
Kullanım Alanı	Kaldırma ekipmanları, vinç ve tarım makinaları

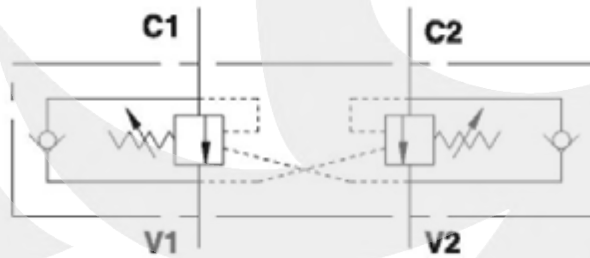

DOUBLE OVERCENTRE VALVES

These valves are used to control the actuator movements and block it in both directions. In order to have the descent of a load under control and avoid the load's weight being carried away the valve will prevent any cavitation of the actuator. Double overcentre valves is different due to the connection positions and the pilot ratio.

Material	Free Cutting Stell
Thread Size	BSP, Metric
Sealing Element	Nitril O-ring (NBR)
Working Temperature	-30°C and 110°C
Plating	Zinc Plated + Cr+3
Heat Treatment	Case Hardened (Internal Parts)
Application	Lifting equipments, Cranes and Agricultural Machines

Stok Kodu Stock Code	Diş Ölçüsü Thread Size	Maksimum Akış Max Flow Debi lt/dk	Maksimum Basınç Max Pressure Pmax Bar	Pilot Oranı Pilot Ratio
KTOC0103802	3/8"	40	350	1:4,5

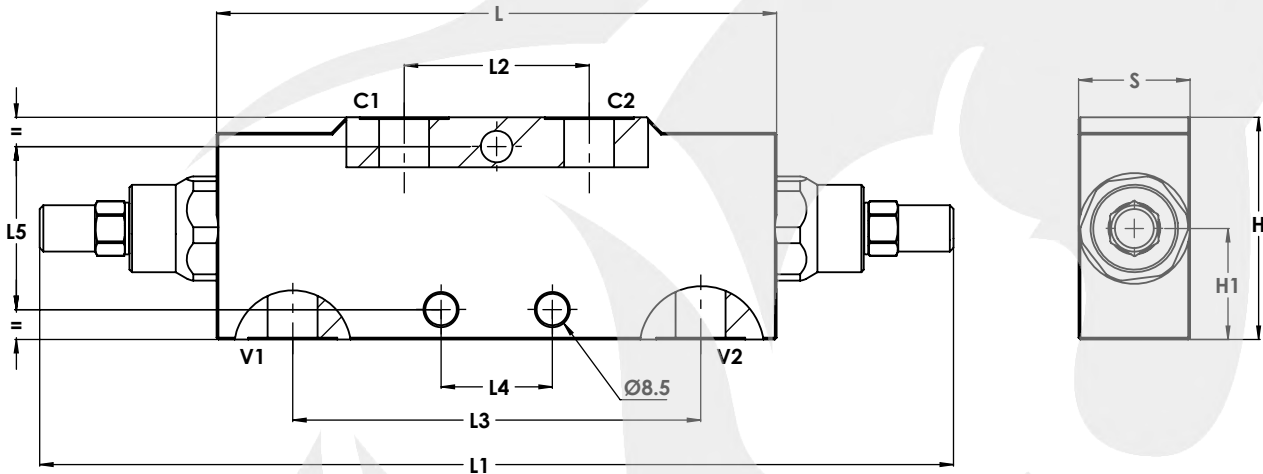

Diş Ölçüsü
Thread Size

Ölçüler
Dimensions - mm

C1-C2 / V1-V2	L	L1	L2	L3	L4	L5	S	H	H1	ØD
3/8"	150	246,50	50	110	30	44	30	60	30	8,5



HİDROLİK BASINÇ EMNİYET VALFLERİ

Bu valfler sisteme girecek basıncın alt ve üst noktasını belirler. Sisteme pompadan gelebilecek her türlü basıncı regüle eder.

Malzeme	Alüminyum
Diş Ölçüsü	G3/8(İsteğe Bağlı BSP, Metrik)
Sızdırmazlık Elemanı	Nitril O-ring (NBR)
Çalışma Sıcaklığı	-30°C ile 110°C Arası
Kaplama	Nikel Kaplama
Isıl İşlem	Sementasyon (İç Parçalarda)
Kullanım Alanı	Kaldırma ekipmanları, vinç hidrolik sistemler ve tarım makineleri

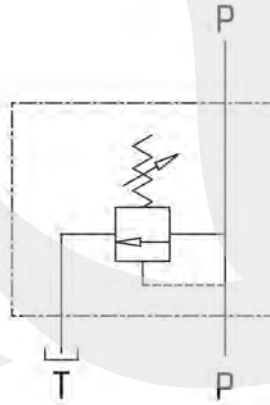

HYDRAULIC RELIEF VALVES

These valves determine the top and bottom pressure entering the system. It regulates all kinds of pressures that can come from the pump into the system.

Material	Aluminum
Thread Size	G3/8(Optional BSP, Metric)
Sealing Element	Nitril O-ring (NBR)
Working Temperature	-30°C and 110°C
Plating	Nickel Plating
Heat Treatment	Cementation (Internal Parts)
Application	Lifting equipments, Crane Hydraulic Systems and Agricultural Machines

Stok Kodu Stock Code	Diş Ölçüsü Thread Size	Maksimum Akış Max Flow Debi lt/dk	Maksimum Basınç Max Pressure Pmax Bar
KTRV0003801	3/8"	40	350
KTRV0001201	1/2"	80	350

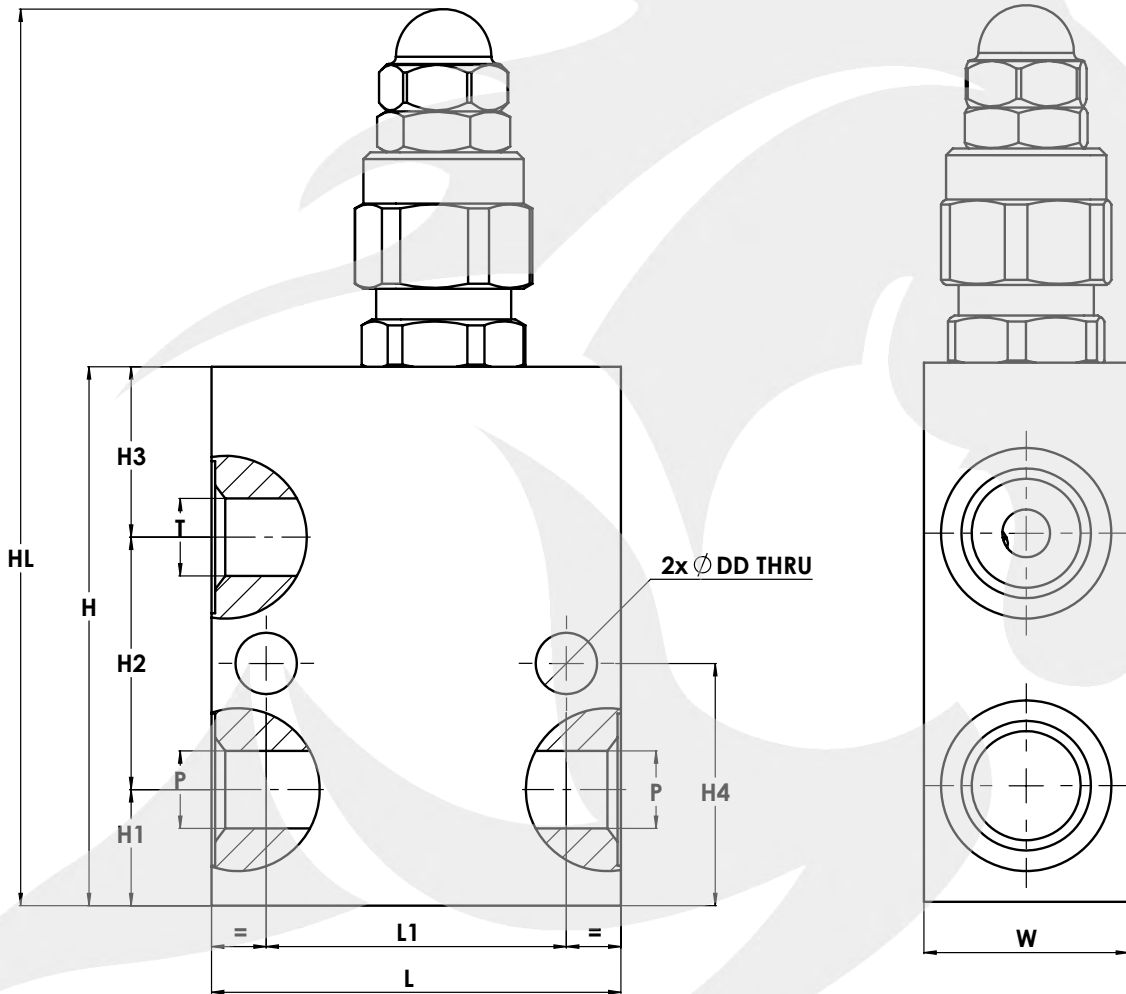

Diş Ölçüsü
Thread Size

Ölçüler
Dimensions - mm

P-T	HL	H	H1	H2	H3	H4	L	L1	W	ØDD
3/8"	132,5	79	17	37	25	35,5	60	44	30	9
1/2	134	78	20	40	18	34	39	58	34,5	6,5

* İsteğe göre G3/4" ölçülerinde üretim yapılabilir.
G3/4" on request.



HİDROLİK BASINÇ EMNİYET VALF KARTİÇLERİ

Bu valfler sisteme girecek basıncın alt ve üst noktasını belirler. Sisteme pompadan gelebilecek her türlü basıncı regüle eder.

Malzeme	Otomat Çeliği
Diş Ölçüsü	M20x1.5 (İsteğe Bağlı değişebilir)
Sızdırmazlık Elemanı	Nitril O-ring (NBR)
Çalışma Sıcaklığı	-30°C ile 110°C Arası
Kaplama	Galvaniz + Cr+3
Isıl İşlem	Sementasyon (İç Parçalarda)
Kullanım Alanı	Kaldırma ekipmanları, vinç hidrolik sistemler ve tarım makinaları

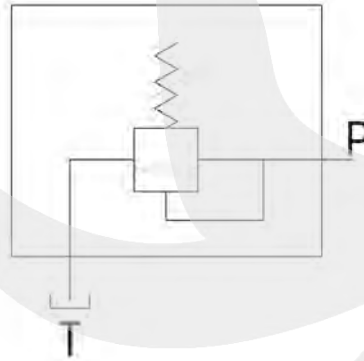

HYDRAULIC RELIEF VALVES CARTIDGE

These valves determine the top and bottom pressure entering the system. It regulates all kinds of pressures that can come from the pump into the system.

Material	Free Cutting Stell
Thread Size	M20x1.5 (Optional)
Sealing Element	Nitril O-ring (NBR)
Working Temperature	-30°C and 110°C
Plating	Zinc Plated + Cr+3
Heat Treatment	Case Hardened (Internal Parts)
Application	Lifting equipments, Crane Hydraulic Systems and Agricultural Machines

Stok Kodu Stock Code	Diş Ölçüsü Thread Size	Maksimum Akış Max Flow Debi lt/dk	Maksimum Basınç Max Pressure Pmax Bar
KTRV0102001	M20x1,5	20-50	350
KTRV0102401	M24x1,5	20-80	320

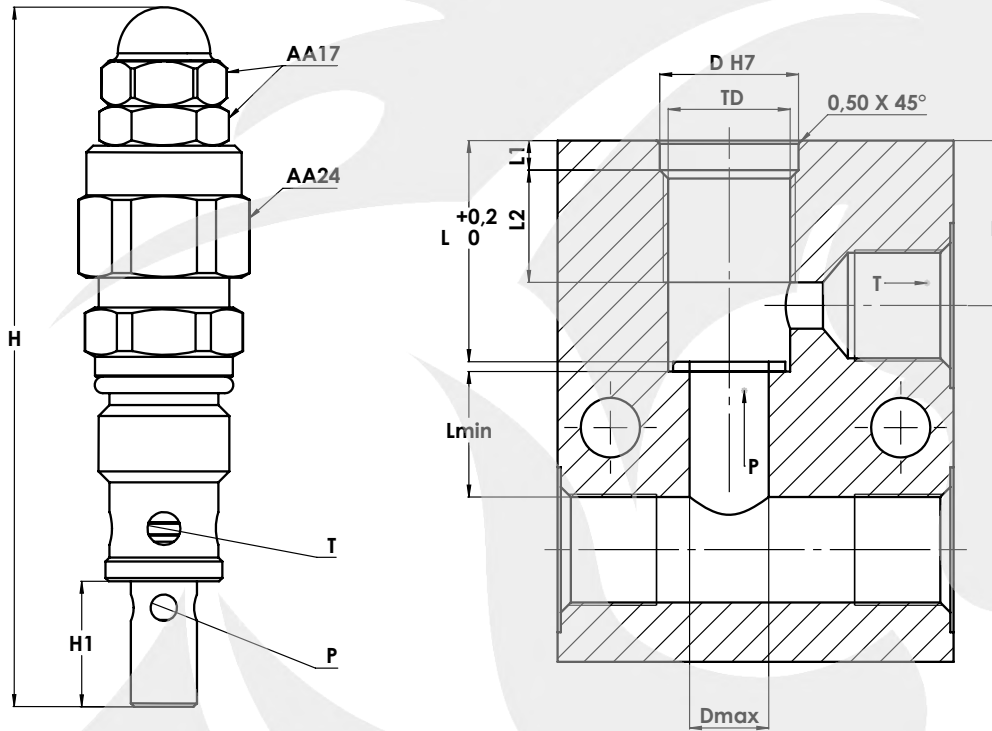

Diş Ölçüsü
Thread Size

Ölçüler
Dimensions - mm

TD	H1	H	Lmin	L	L1	L2	E	ØD	ØDmax
M20x1,5	19	106	19	33,5	4,5	17	25	21	12
M24x1,5	21	123	21	31	4	12	21	27	16



NG06 VALF PLEYTLERİ

NG06 Valf Pleytleri hidrolik sistemlerde pek çok sistem bileşenin birbirleriyle uyumlu ve etkileşimli çalışmasını sağlar. Pleytler montaj ve test süresi, maliyet düşürme, sızıntı noktalarının azaltılması gibi konularda etkin çözüm aracı olarak kullanılırlar.

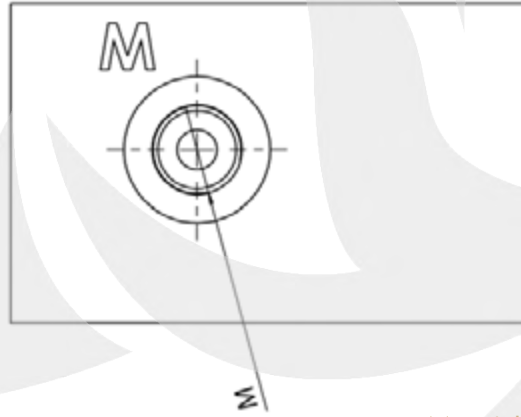

NG06 VALVE PLATES

NG06 Valve Plates allow many system components to work in harmony and interaction with each other in hydraulic systems. Plates are used as an effective solution tool in issues such as assembly and test time, cost reduction, and reduction of leakage points.

Malzeme	Alüminyum
Diş Ölçüsü	M20x1.5 (İsteğe Bağlı değişebilir)
Sızdırmazlık Elemanı	Nitril O-ring (NBR)
Çalışma Sıcaklığı	-30°C ile 110°C Arası
Isıl İşlem	Sementasyon (İç Parçalarda)
Kullanım Alanı	Kaldırma ekipmanları, vinç hidrolik sistemler ve tarım makinaları

Material	Aluminum
Thread Size	M20x1.5 (Optional)
Sealing Element	Nitril O-ring (NBR)
Working Temperature	-30°C and 110°C
Heat Treatment	Case Hardened (Internal Parts)
Application	Lifting equipments, Crane Hydraulic Systems and Agricultural Machines

Bağlantı Tipi Connection Type	Stok Kodu Stock Code	Maksimum Akış Max Flow Debi lt/dk	Maksimum Basınç Max Pressure Pmax Bar
Tekli / Single	KTNG06010381202	40	220
İkili / Two Fold	KTNG06020381202	40	220
Üçlü / Three Fold	KTNG06030381202	40	220
Dörtlü / Four Fold	KTNG06040381202	40	220
Beşli / Five Fold	KTNG06050381202	40	220

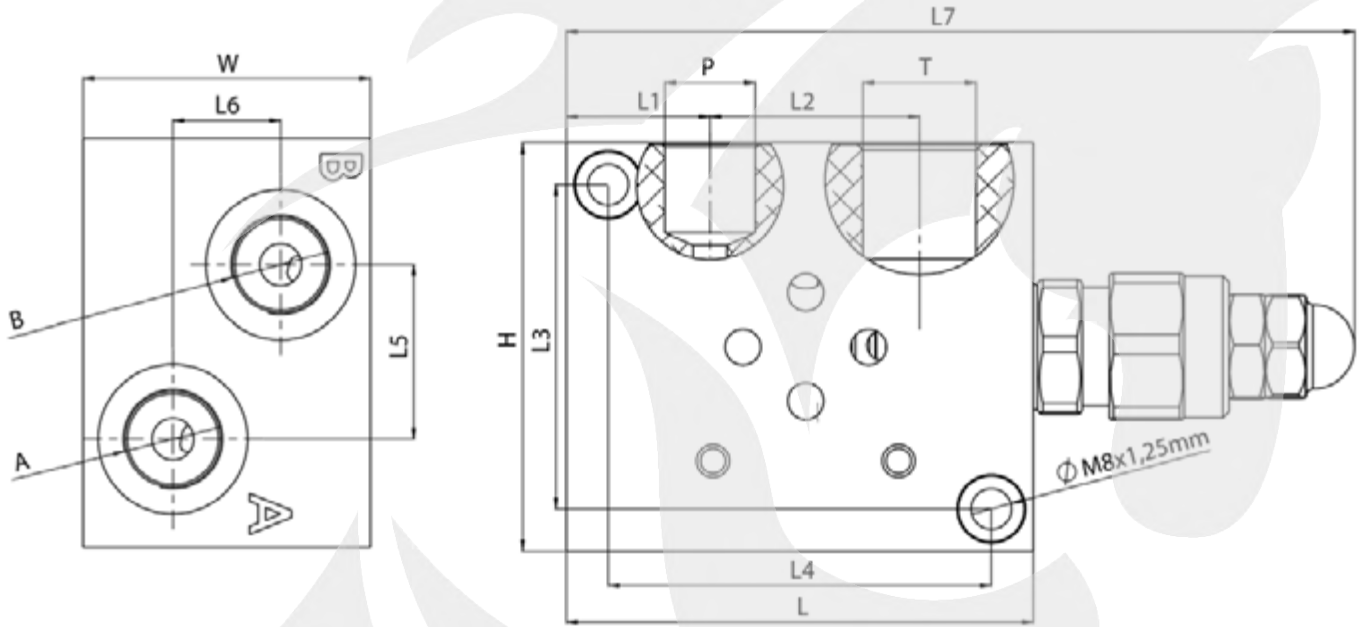

Bağlantı Tipi Connection Type	Stok Kodu Stock Code	Diş Ölçüsü Thread Size			Ölçüler Dimensions - mm									
		T	M	A,B,P	H	H1	W	L	L1	L2	L3	L4	L5	L6
Tekli / Single	KTNG06010381202	G1/2"	G1/4"	G3/8"	68	9	48	78	24	35	54	64	29	18
İkili / Two Fold	KTNG06020381202	G1/2"	G1/4"	G3/8"	165	9	48	78	24	35	54	64	29	18
Üçlü / Three Fold	KTNG06030381202	G1/2"	G1/4"	G3/8"	216	9	48	78	24	35	54	64	29	18
Dörtlü / Four Fold	KTNG06040381202	G1/2"	G1/4"	G3/8"	267	9	48	78	24	35	54	64	29	18
Beşli / Five Fold	KTNG06050381202	G1/2"	G1/4"	G3/8"	318	9	48	78	24	35	54	64	29	18

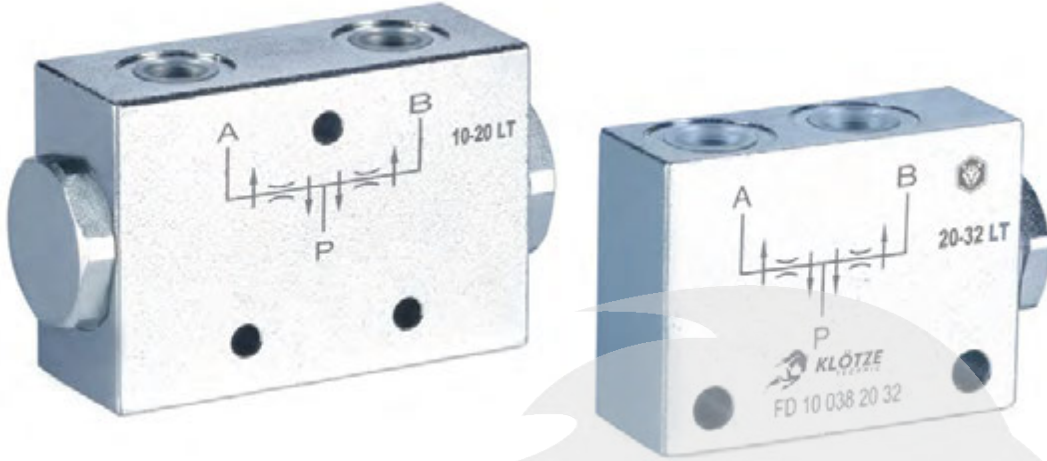

AKIŞ BÖLÜCÜ

Bu valfler, mekanik olarak bağlanmamış, aynı pompa tarafından beslenen ve tek bir vana tarafından kontrol edilen iki eşit silindirin hem uzama hem de geri çekmede aynı anda hareket etmesi gerektiğinde kullanılır.

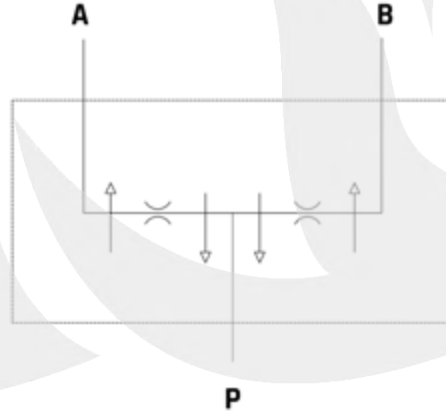

FLOW DIVIDER

These valves are used when two equal actuators, that are not mechanically coupled, supplied by the same pump and controlled by a single valve, must move simultaneously both in extension and retraction.

Malzeme	Otomat Çeliği
Diş Ölçüsü	M20x1.5 (İsteğe Bağlı değişebilir)
Sızdırmazlık Elemanı	Nitril O-ring (NBR)
Çalışma Sıcaklığı	-30°C ile 110°C Arası
Kaplama	Galvaniz + Cr+3
Isıl İşlem	Sementasyon (İç Parçalarda)
Kullanım Alanı	Kaldırma ekipmanları, vinç hidrolik sistemler ve tarım makineleri

Material	Free Cutting Stell
Thread Size	M20x1.5 (Optional)
Sealing Element	Nitril O-ring (NBR)
Working Temperature	-30°C and 110°C
Plating	Zinc Plated + Cr+3
Heat Treatment	Case Hardened (Internal Parts)
Application	Lifting equipments, Crane Hydraulic Systems and Agricultural Machines

Stok Kodu Stock Code	Malzeme Cinsi Type	Diş Ölçüsü Thread Size	Maksimum Akış Max Flow Debi lt/dk	Maksimum Basınç Max Pressure Pmax Bar
KTFD100382032	DFL 20-32 G3/8"	G3/8"	32	300
KTFD100380610	DFL 6-10 G3/8"	G3/8"	10	300
KTFD100381020	DFL 10-20 G3/8"	G3/8"	20	300
KTFD100122540	DFL 25-40 G1/2"	G1/2"	40	300
KTFD100124060	DFL 40-60 G1/2"	G1/2"	60	300

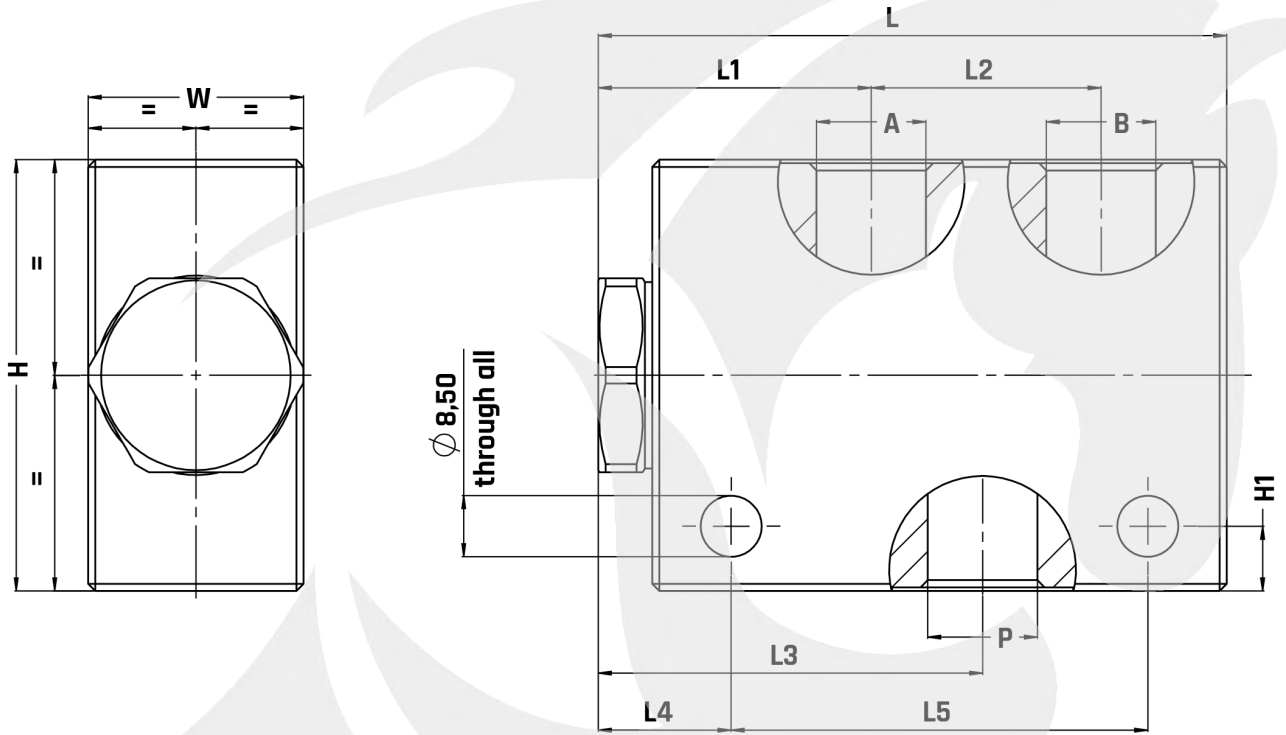

Stok Kodu Stock Code	Diş Ölçüsü Thread Size	Ölçüler Dimensions - mm									
		P,A,B	H	H1	W	L	L1	L2	L3	L4	L5
KTFD100382032	G3/8"		60	9	30	87,5	38	32	53,5	18,5	58
KTFD100380610	G3/8"		60	9	30	87,5	38	32	53,5	18,5	58
KTFD100381020	G3/8"		60	9	30	87,5	38	32	53,5	18,5	58
KTFD100122540	G1/2"		60	9	30	87,5	38	53	53,5	18,5	58
KTFD100124060	G1/2"		60	9	30	87,5	38	53	53,5	18,5	58



KOMBİNASYONLU BASINÇ SIRALAMA VALFLERİ

İki basınç altındaki silindirin sırayla çalıştırılması işlemini görür. Birinci konumda bulunan silindirin basınç uygulanması durumunda silindiri aşağı indirir tekrar basınç uygulandığında sıfır konumuna gelir. Sistem bu durumda yön değiştirir tekrar basınç uygulandığında ikinci silindir harekete geçer ikinci silindirin sıfır konumuna gelmesi birinci silindirin yeniden harekete geçmesini sağlar.

HYDRAULIC COMBİNE SEQUENCE VALVES

It sees the operation of sequentially operating the cylinder under two pressures. In the case of applying pressure to the cylinder located in the first position, the cylinder is lowered and reaches is zero position. In this case, the system changes direction. When the pressure is again applied, the second cylinder moves and the second cylinder arrives at the position zero, so that the first cylinder can move again.

Malzeme	Sfero Döküm (GGG40)
Diş Ölçüsü	M18X1.5
Sızdırmazlık Elemanı	Nitril O-ring (NBR)
Çalışma Sıcaklığı	-30°C ile 110°C Arası
Kaplama	Statik Boyalı
Isıl İşlem	Sementasyon (İç Parçalarda)
Kullanım Alanı	Tarım makineleri ve diğer hidrolik sistemler (mibzer çizici)

Material	Ductile Cast Iron (GGG40)
Thread Size	M18X.5
Sealing Element	Nitril O-ring (NBR)
Working Temperature	-30°C and 110°C
Plating	Painted
Heat Treatment	Case Hardened (Internal Parts)
Application	Agricultural machinery and other hydraulic systems (Planter marker)

TEK ETKİLİ İŞARETLEYİCİ B SİLİNDİRİ
SINGLE ACTING MARKER B CYLINDER

TEK ETKİLİ İŞARETLEYİCİ A SİLİNDİRİ
SINGLE ACTING MARKER A CYLINDER

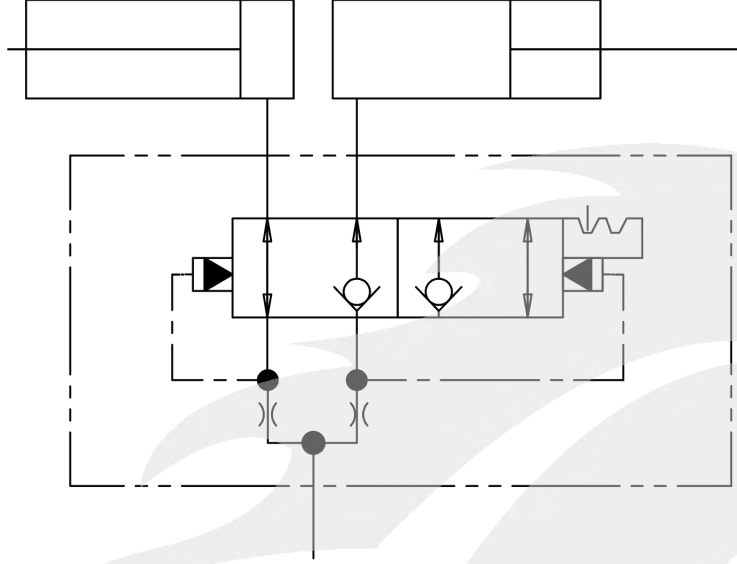

TRAKTÖR VALFİNE BAĞLI
CONNECTING TO THE TRACTOR VALVE

Stok Kodu
Stock Code

Diş Ölçüsü
Thread Size
A,B,P

Ölçüler
Dimensions - mm

	EA	TL	ØDD	EA2	H1	H	K
KTSV0101802	52	96,5	8,5	40	67,5	76,5	31

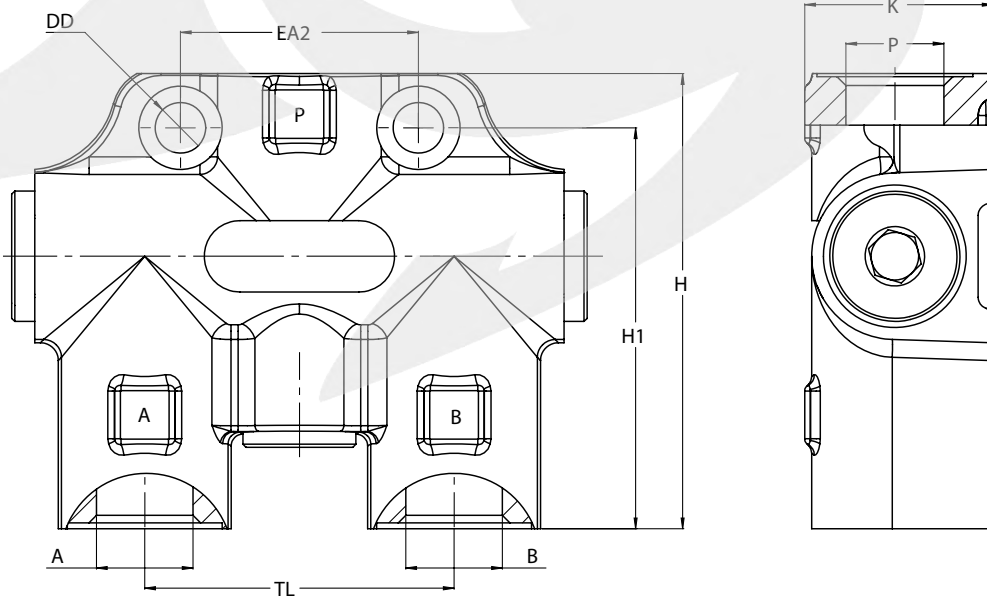



ÇİFT ETKİLİ KOMBİNASYONLU BASINÇ SIRALAMA VALFLERİ

Kombinasyonlu basınç sıralama valfinden farkı çift etkili silindirlerde kullanılır.

DOUBLE EFFECT HYDRAULIC COMBINED SEQUENCE VALVES

The difference from the combination pressure sequencing valve is used in double-acting cylinders.

Malzeme	Sfero Döküm (GGG40)
Diş Ölçüsü	G 3/8
Sızdırmazlık Elemanı	Nitril O-ring (NBR)
Çalışma Sıcaklığı	-30°C ile 110°C Arası
Kaplama	Fosfat Kaplama
Isıl İşlem	Sementasyon (İç Parçalarda)
Kullanım Alanı	Tarım makineleri ve diğer hidrolik sistemler (mibzer çizici)

Material	Ductile Cast Iron (GGG40)
Thread Size	M18X.5
Sealing Element	Nitril O-ring (NBR)
Working Temperature	-30°C and 110°C
Plating	Phosphate Coating
Heat Treatment	Case Hardened (Internal Parts)
Application	Agricultural machinery and other hydraulic systems (Planter marker)

ÇİFT ETKİLİ İŞARETLEYİCİ B SİLİNDİRİ
DOUBLE ACTING MARKER B CYLINDER

ÇİFT ETKİLİ İŞARETLEYİCİ A SİLİNDİRİ
DOUBLE ACTING MARKER A CYLINDER

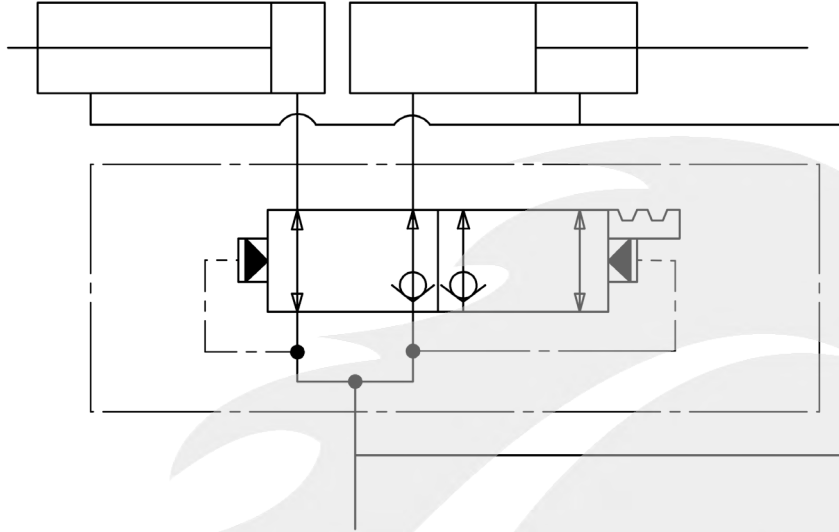

TRAKTÖR VALFİNE BAĞLI
CONNECTING TO THE TRACTOR VALVE

Stok Kodu
Stock Code

Diş Ölçüsü
Thread Size
A,B

Ölçüler
Dimensions - mm

	EA2	EA	TL	K	H	D	EA3
KTSV0101801	80	26	100	63	62	M8x1,25	12.2

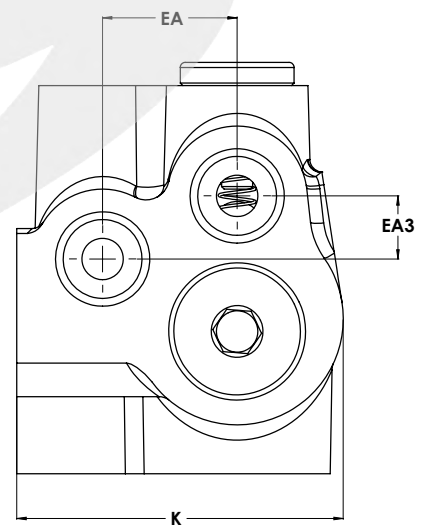
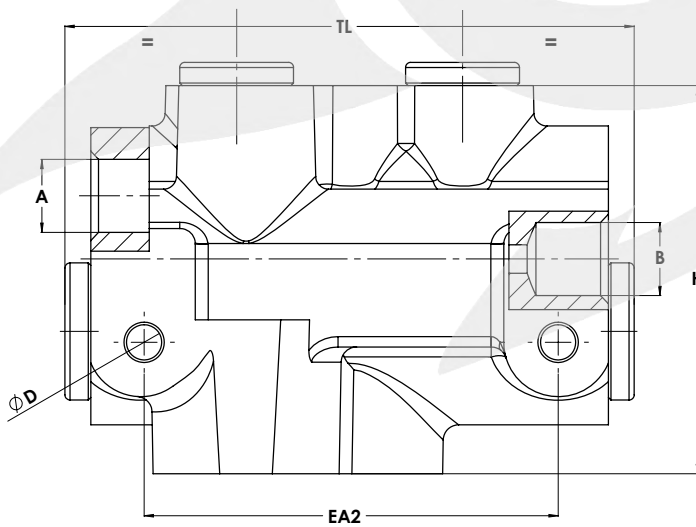



KÖRLEME TAPALARI

Körleme tapaları, sıvı teknolojisindeki deliklerin güvenli, hızlı ve ekonomik sızdırmazlığı için kullanılır, Örn. jig ve fiktür yapımında hidrolik delme delikleri. Montaj, öngörülen ayar kalıbı vasıtasıyla sızdırmazlık tıpasının delme deliğine bastırılmasıyla gerçekleştirilir.

Malzeme Paslanmaz Çelik 1.4305

Diş Ölçüsü BSP, Metrik

Çalışma Sıcaklığı -30°C ile 110°C Arası

Kullanım Alanı Bloklarda

SEALING PLUGS

Sealing plugs are used for safe, quick and economic sealing of bore holes in fluid technology, e.g. hydraulic drilling holes in jig and fixture construction. Assembly is effected by pressing in the sealing plug into the drilling hole by means of the prescribed setting die.

Material Stainless steel 1.4305

Thread Size BSP, Metric

Working Temperature -30°C and 110°C

Application Block

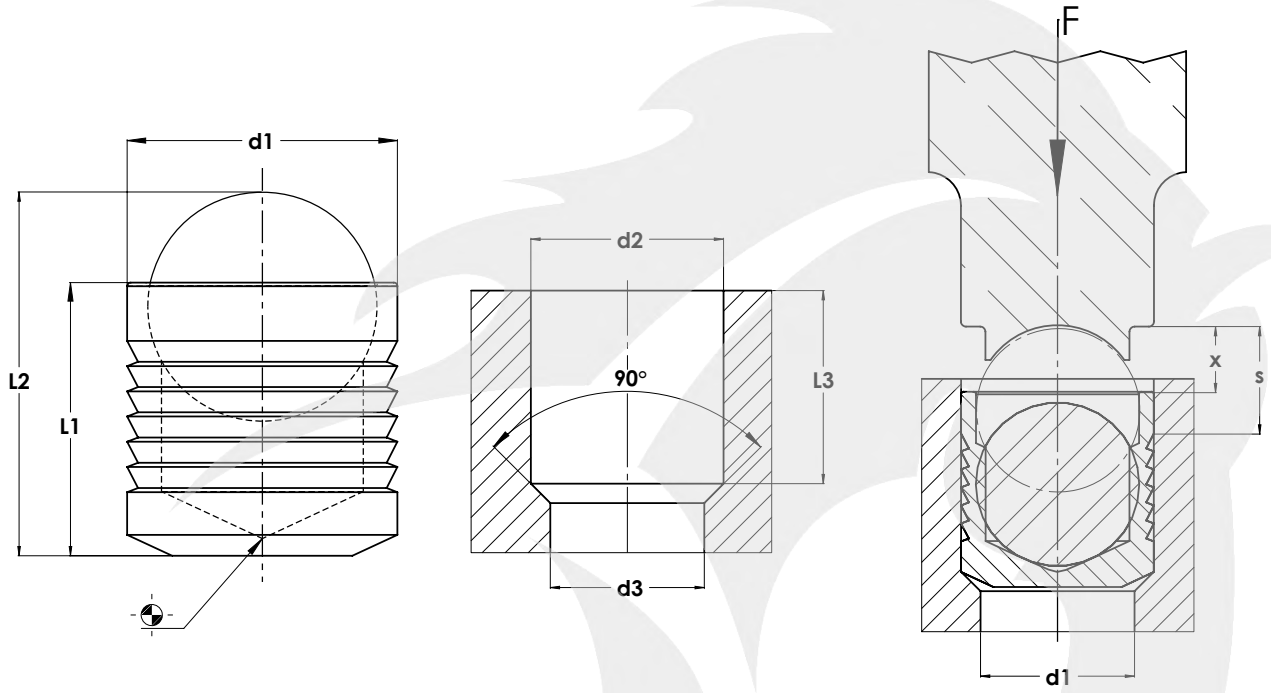

Stok Kodu
Stock Code

Ölçüler
Dimensions - mm

	d1	L1	L2 ~	d2 +0.1	d3 max.	L3 min.	x ±0.2	s	 [g]
KTYM4300500 Ø5	5	5.5	7.0	5	4.3	5.3	0.4	2.00	0.70
KTYM4300600 Ø6	6	6.5	8.6	6	5.3	6.3	0.4	2.50	1.30
KTYM4300700 Ø7	7	7.5	10.1	7	6.4	7.3	0.4	3.00	2.40
KTYM4300800 Ø8	8	8.5	11.7	8	7.4	8.3	0.3	3.50	3.20
KTYM4300900 Ø9	9	10.0	13.7	9	8.4	9.8	0.4	4.00	4.50
KTYM4301000 Ø10	10	11.0	15.2	10	9.4	10.8	0.4	4.50	6.10
KTYM4301200 Ø12	12	13.0	18.0	12	10.6	12.8	0.4	5.50	9.70



HİDROLİK İKİ YOLLU KÜRESEL VANA

Bu vanalar, maksimum basınçta bile bir devrede yağ akışını açmak veya kapatmak için kullanılır.

Malzeme	Otomat Çeliği
Küre Malzemesi	Sert Krom Kaplı Çelik
Diş Ölçüsü	BSP (İsteğe Bağlı)
Küre Malzemesi	PTFE (Teflon)
Sızdırmazlık Elemanı	Nitril O-ring (NBR)
Çalışma Sıcaklığı	-30°C ile 110°C Arası
Kaplama	Galvaniz + Cr+3
Kullanım Alanı	Kaldırma ekipmanları, vinç hidrolik sistemler ve tarım makineleri

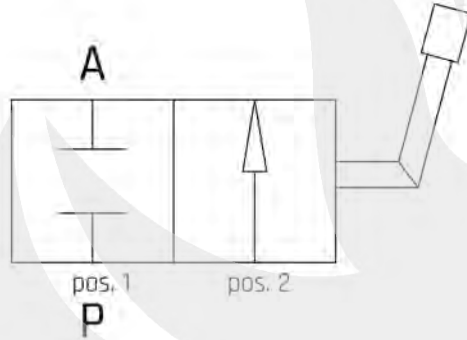

HYDRAULIC TWO WAY BALL VALVES

These valves are used to open or close oil flow in a circuit even with maximum pressure.

Material	Free Cutting Stell
Ball Material	Hard Chrome Plated Steel
Thread Size	BSP (Optional)
Ball Seat Material	PTFE (Teflon)
Sealing Element	Nitril O-ring (NBR)
Working Temperature	-30°C and 110°C
Plating	Zinc Plated + Cr+3
Application	Lifting equipments, Crane Hdraulic Systems and Agricultural Machines

Stok Kodu Stock Code	Diş Ölçüsü Thread Size	Maksimum Akış Max Flow Debi lt/dk	Maksimum Basınç Max Pressure Pmax Bar
KTFD0201402	1/4"	20	500
KTFD0203802	3/8"	47	500
KTFD0201202	1/2"	63	500

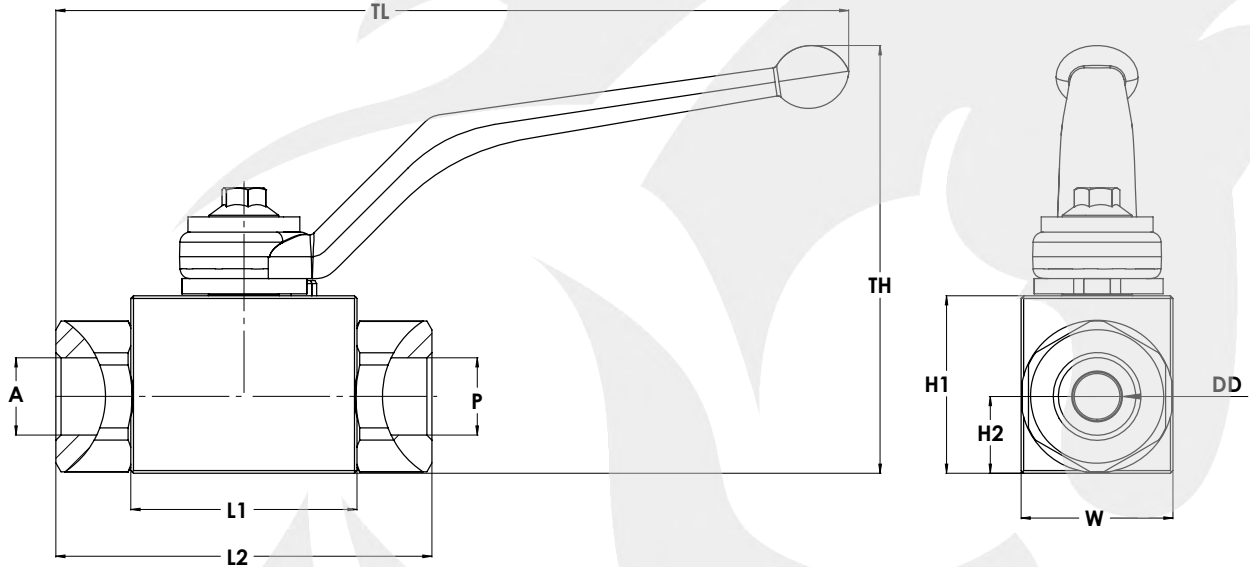

Diş Ölçüsü
Thread Size

Ölçüler
Dimensions - mm

A,P	L1	L2	TH	H1	H2	ØDD	W	TL
1/4"	39	69	82	32,5	13,6	7	30	154
3/8"	44	74	85	34,5	15,2	9,5	30	156,5
1/2"	47	83	90,5	41	19,2	13	35	160,5



HİDROLİK ÜÇ YOLLU L TİPİ KÜRESEL VANA

Akışın 2 farklı çıkış noktasına doğru yönlendirilmesi için 3 yollu yön değiştirici kullanılır.

Malzeme	Otomat Çeliği
Küre Malzemesi	Sert Krom Kaplı Çelik
Diş Ölçüsü	BSP (İsteğe Bağlı)
Küre Malzemesi	PTFE (Teflon)
Sızdırmazlık Elemanı	Nitril O-ring (NBR)
Çalışma Sıcaklığı	-30°C ile 110°C Arası
Kaplama	Galvaniz + Cr+3
Kullanım Alanı	Kaldırma ekipmanları, vinç hidrolik sistemler ve tarım makineleri

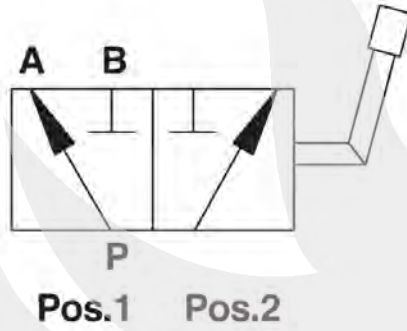

HYDRAULIC THREE WAY L TYPE BALL VALVES

3 ways diverter valves is used to divert the flow towards 2 different outlets.

Material	Free Cutting Stell
Ball Material	Hard Chrome Plated Steel
Thread Size	BSP (Optional)
Ball Seat Material	PTFE (Teflon)
Sealing Element	Nitril O-ring (NBR)
Working Temperature	-30°C and 110°C
Plating	Zinc Plated + Cr+3
Application	Lifting equipments, Crane Hdraulic Systems and Agricultural Machines

Stok Kodu Stock Code	Diş Ölçüsü Thread Size	Maksimum Akış Max Flow Debi lt/dk	Maksimum Basınç Max Pressure Pmax Bar
KTFD0301402	1/4"	20	500
KTFD0303802	3/8"	47	500
KTFD0301202	1/2"	63	500

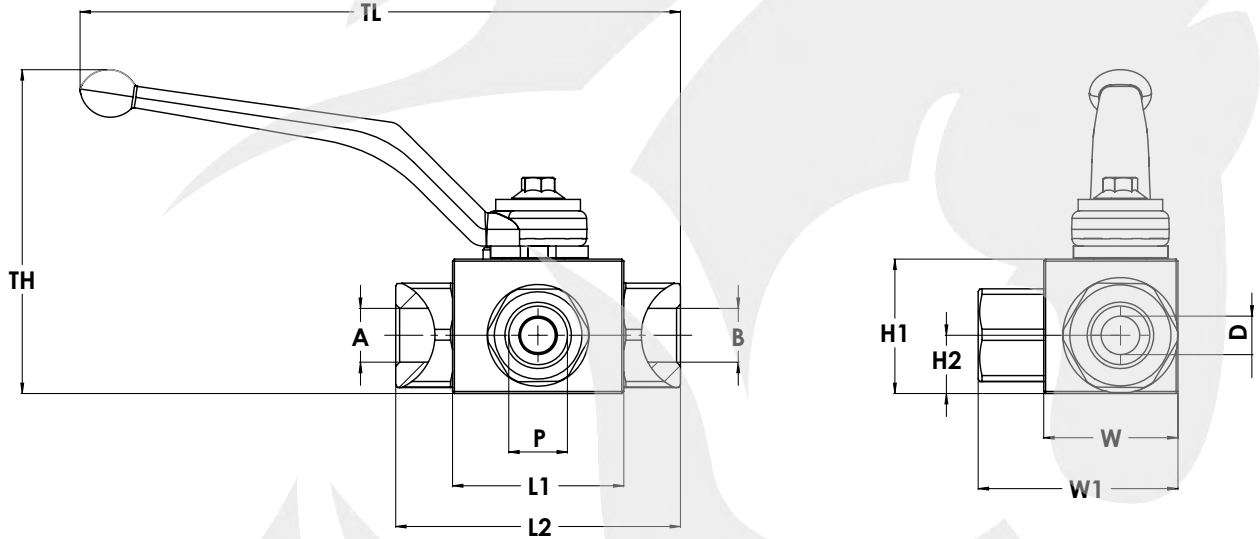

Diş Ölçüsü
Thread Size

Ölçüler
Dimensions - mm

A,P	L1	L2	TH	H1	H2	W	TL
1/4"	39	69	82	32,5	13,6	30	154
3/8"	44,5	74	84	35	15	35	156
1/2"	47	83	90,5	41	19,2	35	160,5



HİDROLİK ÜÇ YOLLU VANA

Akışın 2 farklı çıkış noktasına doğru yönlendirilmesi için 3 yollu yön değiştirici kullanılır.

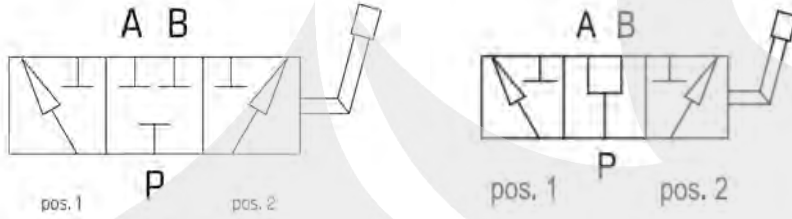

Malzeme	Sfero Döküm (GGG40)
Diş Ölçüsü	BSP (İsteğe Bağlı Metrik)
Sızdırmazlık Elemanı	Nitril O-ring (NBR)
Çalışma Sıcaklığı	-30°C ile 110°C Arası
Kaplama	Fosfat Kaplama
Isıl İşlem	Sementasyon (İç Parçalarda)
Kullanım Alanı	Kaldırma ekipmanları, vinç hidrolik sistemler ve tarım makineleri

HYDRAULIC THREE WAY FLOW DIVIDER

3 ways diverter valves is used to divert the flow towards 2 different outlets.

Material	Ductile Cast Iron (GGG40)
Thread Size	BSP (Optional)
Sealing Element	Nitril O-ring (NBR)
Working Temperature	-30°C and 110°C
Plating	Phosphate Coating
Heat Treatment	Case Hardened (Internal Parts)
Application	Lifting equipments, Crane Hydraulic Systems and Agricultural Machines

Stok Kodu Stock Code	Diş Ölçüsü Thread Size	Maksimum Akış Max Flow Debi lt/dk	Maksimum Basınç Max Pressure Pmax Bar
KTFD0303801	3/8"	60	300
KTFD0301201	1/2"	90	250
KTFD0303401	3/4"	140	220
KTFD0310001	1"	200	220
KTFD0315001	1" 1/2	300	180

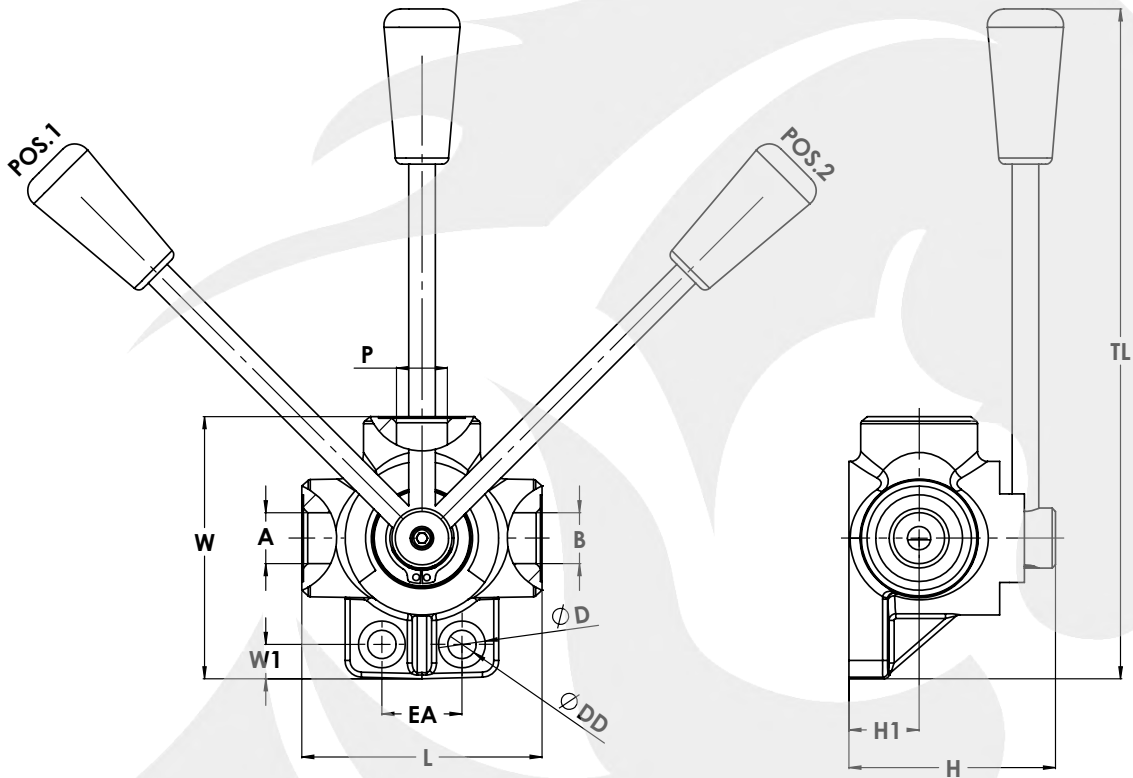

Diş Ölçüsü
Thread Size

Ölçüler
Dimensions - mm

A,B,P	ØDD	ØD	EA	L	H	H1	W	W1	TL
3/8"	8,5	15	30	72	65,5	21,5	77,5	11,25	153
1/2"	8,5	15	32	88	73	25,5	97	14,1	165
3/4"	11	17	32	94	82	30	103	14	183
1"	11	18	32	98	84	30	105	12	228
1" 1/2	11	18	32	115	100	36	129	12	232



HİDROLİK DÖRT YOLLU VANA

Bu valf, yağ akışını iki yoldan iki yöne doğru ters çevirmek için kullanılır. Bir çift etkili aktüatörleri kontrol etmek veya bir hidrolik motorun dönüşünü tersine çevirmek için kullanılabilir.

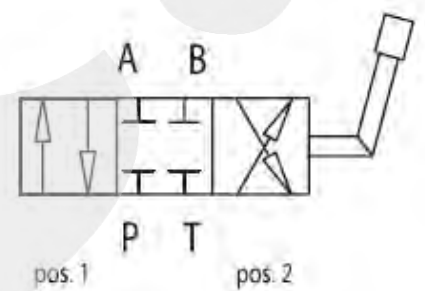
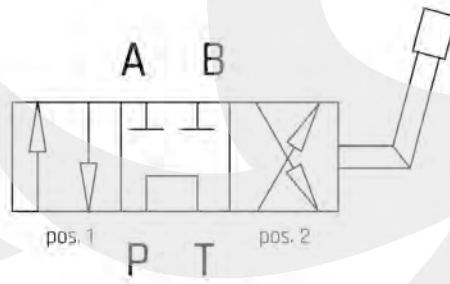
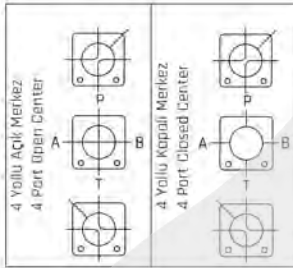

HYDRAULIC FOUR WAY FLOW DIVIDER

This valve is used to reverse oil flow from 2 ways in towards two ways out. It could be used to control a double acting actuators or to reverse the rotation of an hydraulic motor.

Malzeme	Sfero Döküm (GGG40)
Diş Ölçüsü	BSP (İsteğe Bağlı Metrik)
Sızdırmazlık Elemanı	Nitril O-ring (NBR)
Çalışma Sıcaklığı	-30°C ile 110°C Arası
Kaplama	Fosfat Kaplama
Isıl İşlem	Sementasyon (İç Parçalarda)
Kullanım Alanı	Kaldırma ekipmanları, vinç hidrolik sistemler ve tarım makineleri

Material	Ductile Cast Iron (GGG40)
Thread Size	BSP (Optional)
Sealing Element	Nitril O-ring (NBR)
Working Temperature	-30°C and 110°C
Plating	Phosphate Coating
Heat Treatment	Case Hardened (Internal Parts)
Application	Lifting equipments, Crane Hydraulic Systems and Agricultural Machines

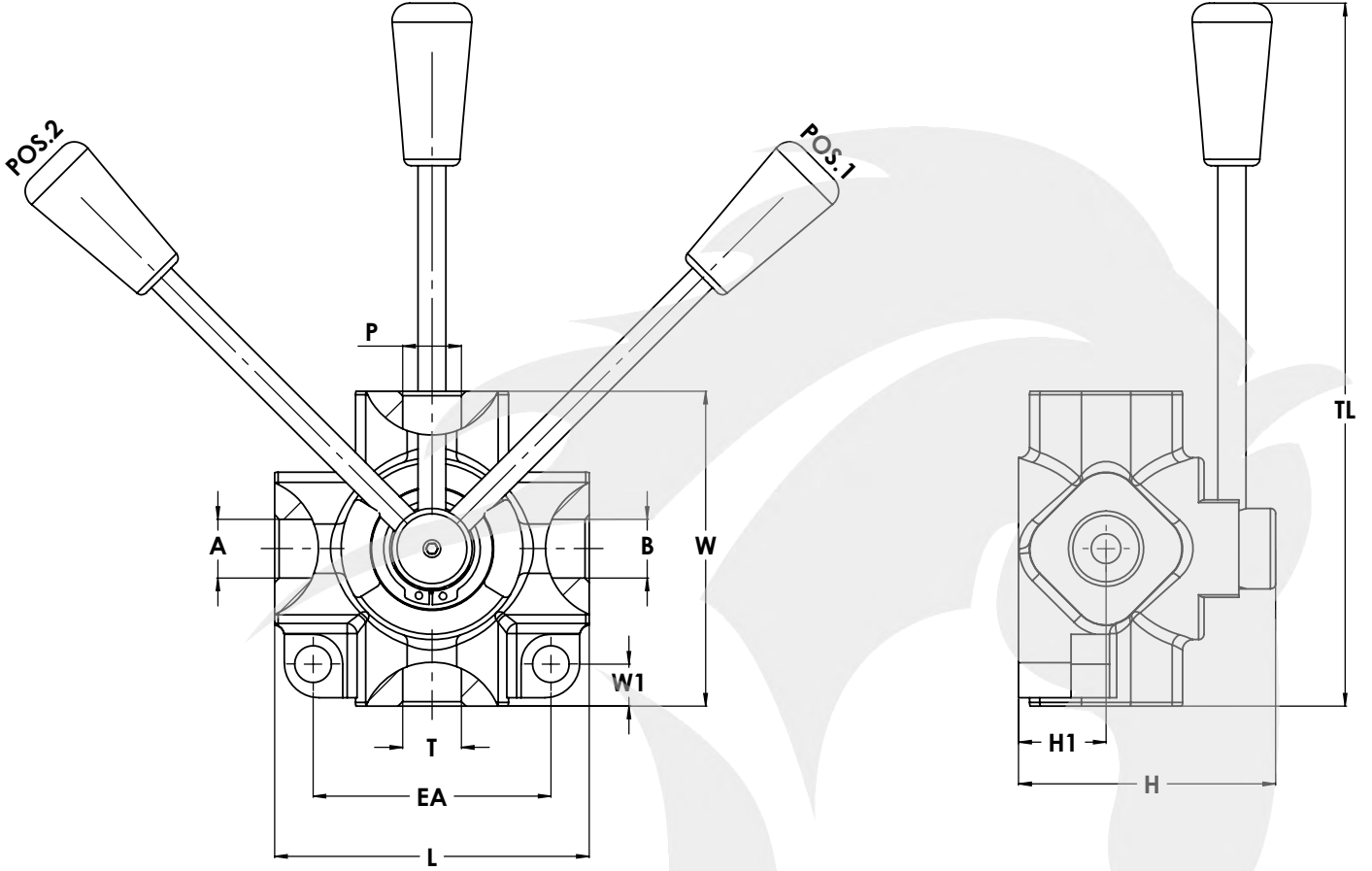

Stok Kodu
Stock Code

Diş Ölçüsü
Thread Size
A,B/T,P

Maksimum Akış
Max Flow
Debi lt/dk

Maksimum Basınç
Max Pressure
Pmax Bar

Ölçüler
Dimensions - mm

	EA	L	H	H1	W	TL	TL
KTFD0401201	68	90	73	25	90	12	166,5

* İsteğe göre G3/8" ölçülerinde üretim yapılabilir.
G3/8" on request.

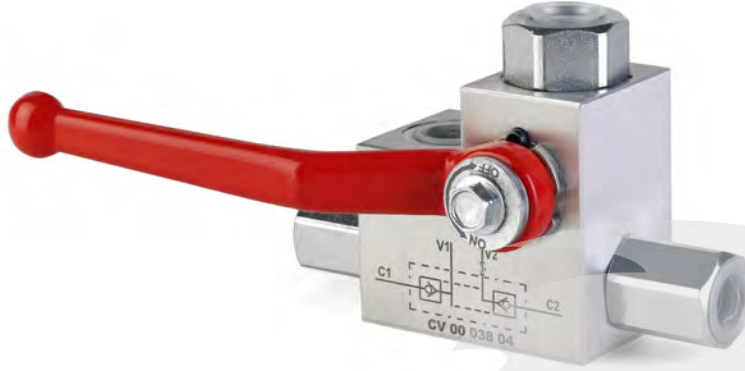

T HATTI KÜRESEL VANALI İKİZ KİLİTLEME VALFİ

3/8 ikiz kilitleme valflerinin üzerinde t hattı küresel vana ile opsiyonlandırılmıştır.

Malzeme	Alüminyum
Diş Ölçüsü	G 3/8 (İsteğe Bağlı Metrik)
Sızdırmazlık Elemanı	Nitril O-ring (NBR)
Çalışma Sıcaklığı	-30°C ile 110°C Arası
Kaplama	Galvaniz + Cr+3
Isıl İşlem	Sementasyon (İç Parçalarda)
Kullanım Alanı	Kaldırma ekipmanları, vinç hidrolik sistemler ve tarım makineleri

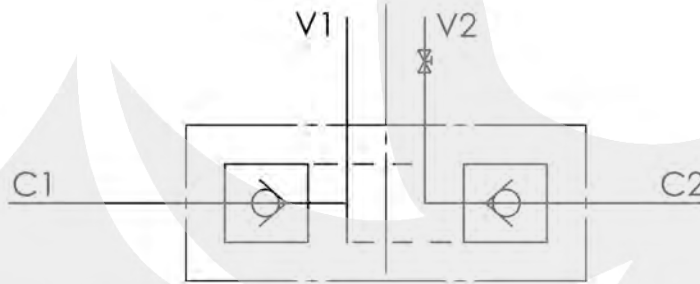

T PORT BALL VALF DOUBLE PILOT OPERATED CHECK VALVE

On the 3/8 twin locking valves, t line is optioned with a ball valve.

Material	Aluminum
Thread Size	G1/2 (Optional)
Sealing Element	Nitril O-ring (NBR)
Working Temperature	-30°C and 110°C
Plating	Zinc Plated + Cr+3
Heat Treatment	Case Hardened (Internal Parts)
Application	Lifting equipments, Crane Hydraulic Systems and Agricultural Machines

Stok Kodu Stock Code	Diş Ölçüsü Thread Size	Maksimum Akış Max Flow Debi lt/dk	Maksimum Basınç Max Pressure Pmax Bar	Pilot Oranı Pilot Ratio	Açma Basıncı Cracking Pressure Bar
KTCV0003806	3/8"	47	300	1:4	6

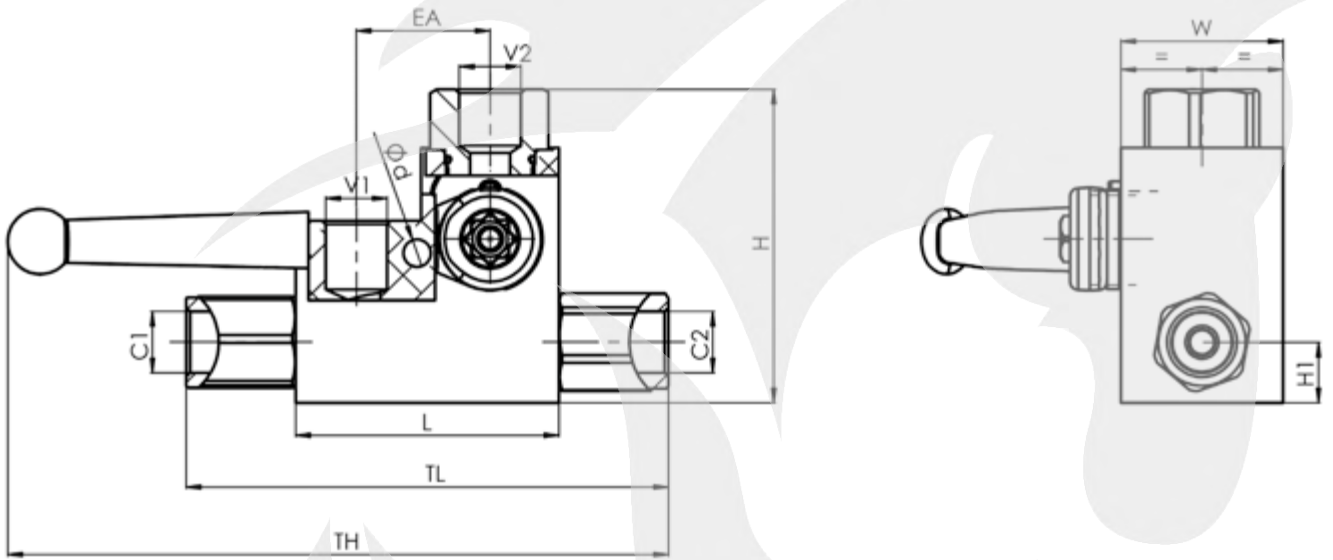

Diş Ölçüsü
Thread Size

Ölçüler
Dimensions - mm

C1-C2-V1-V2	EA	L	TL	w	ØD	H	TH	H1	W
3/8"	33	65	119	62	m8x1,25	77,5	163	15	40



HİDROLİK ALTI YOLLU VANA

Bu vana akışı 2 yoldan 4 port'a yönlendirmek için kullanılır (alternatif olarak iki kere). 2 aktüatörü kontrol etmek için kullanılırlar.

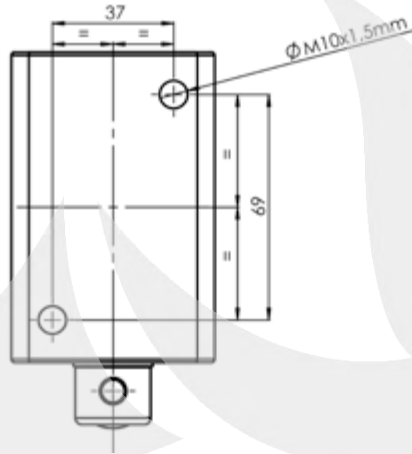

HYDRAULIC SIX WAY FLOW DIVIDER

This valve is used to divert the flow from 2 ways in towards 4 ports (two at time alternatively). They are used to control 2 actuators.

Malzeme	Çelik
Diş Ölçüsü	G3/8" (İsteğe Bağlı Metrik)
Sızdırmazlık Elemanı	Nitril O-ring (NBR)
Çalışma Sıcaklığı	-30°C ile 110°C Arası
Kaplama	Galvaniz + Cr+3
Isıl İşlem	Sementasyon (İç Parçalarda)
Kullanım Alanı	Kaldırma ekipmanları, vinç hidrolik sistemler ve tarım makineleri

Material	Steel
Thread Size	G1/2 (Optional)
Sealing Element	Nitril O-ring (NBR)
Working Temperature	-30°C and 110°C
Plating	Zinc Plated + Cr+3
Heat Treatment	Case Hardened (Internal Parts)
Application	Lifting equipments, Crane Hydraulic Systems and Agricultural Machines

Stok Kodu Stock Code	Diş Ölçüsü Thread Size	Maksimum Akış Max Flow Debi lt/dk	Maksimum Basınç Max Pressure Pmax Bar
KTFD0601202	1/2"	50	350
KTFD0603802	3/8"	35	350

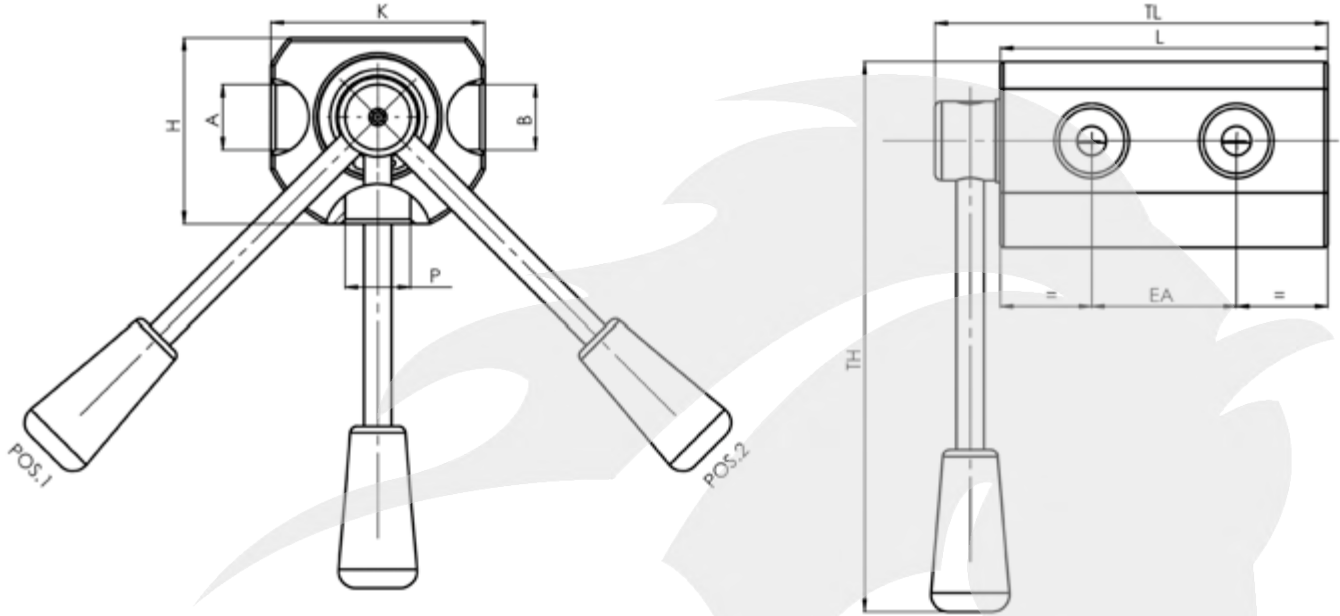

Diş Ölçüsü
Thread Size

Ölçüler
Dimensions - mm

A-B-P-T	EA	L	TL	K	H	TH
1/2"	36-42	95	114,5	62	62	152,5
3/8"	36-42	95	114,5	62	62	152,5
3/8" *	36	72	92.20	57	50.50	141.50

*İsteğe göre G1/2" ölçülerinde üretim yapılabilir.
G1/2" on request.

*Mini altı yollu vana
Mini six way flow divider

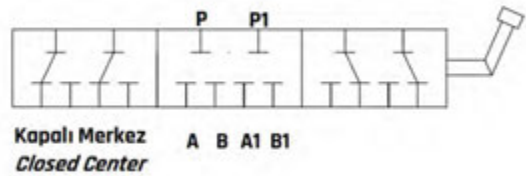
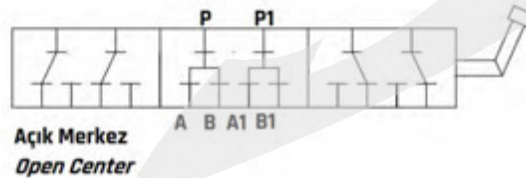



HİDROLİK DÖKÜM ALTI YOLLU VANA

Bu vana akışı 2 yoldan 4 port'a yönlendirmek için kullanılır (alternatif olarak iki kere). 2 aktüatörü kontrol etmek için kullanılırlar.

Malzeme	Döküm
Diş Ölçüsü	G3/8" (İsteğe Bağlı Metrik)
Sızdırmazlık Elemanı	Nitril O-ring (NBR)
Çalışma Sıcaklığı	-30°C ile 110°C Arası
Kaplama	Galvaniz + Cr+3
Isıl İşlem	Sementasyon (İç Parçalarda)
Kullanım Alanı	Kaldırma ekipmanları, vinç hidrolik sistemler ve tarım makineleri

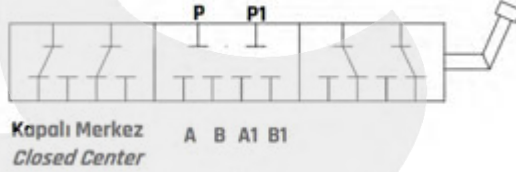
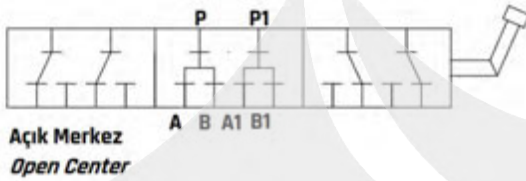

HYDRAULIC CASTING SIX WAY FLOW DIVIDER

This valve is used to divert the flow from 2 ways in towards 4 ports (two at time alternatively). They are used to control 2 actuators.

Material	Casting
Thread Size	G1/2 (Optional)
Sealing Element	Nitril O-ring (NBR)
Working Temperature	-30°C and 110°C
Plating	Zinc Plated + Cr+3
Heat Treatment	Case Hardened (Internal Parts)
Application	Lifting equipments, Crane Hydraulic Systems and Agricultural Machines

Stok Kodu Stock Code	Diş Ölçüsü Thread Size	Maksimum Akış Max Flow Debi lt/dk	Maksimum Basınç Max Pressure Pmax Bar
KTFD1601201	1/2"	50	350
KTFD1603801	3/8"	35	350

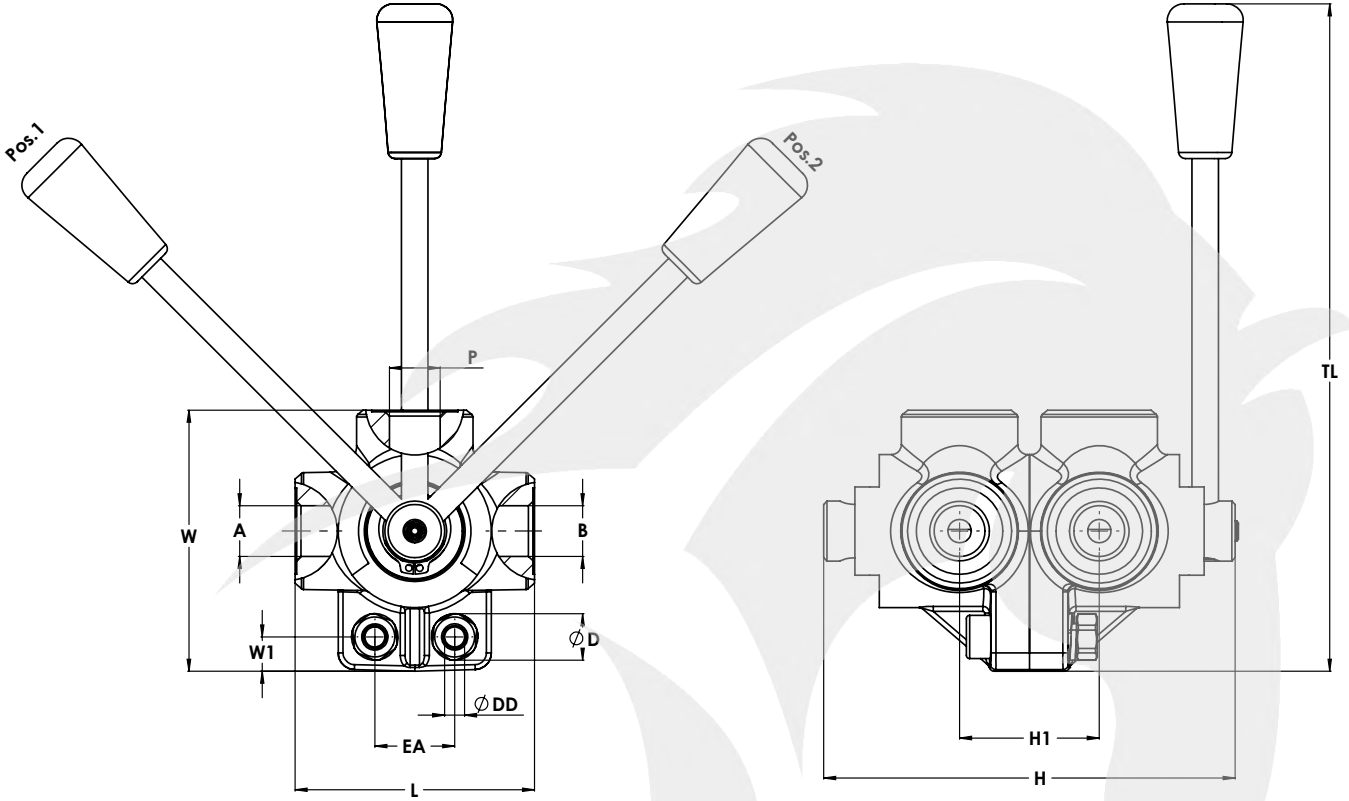

Diş Ölçüsü
Thread Size

Ölçüler
Dimensions - mm

A-B-P-T	EA	L	TL	W	W1	H	H1
1/2"	32	84	215	92,5	10	132	51
3/8"	24	72	200	78,5	10	124	42

*İsteğe göre G1/2" ölçülerinde üretim yapılabilir.
G1/2" on request.



HİDROLİK ÇİFT İKİZ KİLİTLEME VALFLİ MONO BLOK ALTI YOLLU VANA

Altı yollu vananın üzerine ikiz kilitleme valfi bağlanmış tek parça vanadır. Altı yollu vananın kontrol ettiği her iki silindiri de kilitli ve stabil tutar.

HYDRAULIC SIX FLOW DIVIDER WITH DOUBLE PILOT OPERATED CHECK VALVE MONOBLOCK

The six-way valve is a one-piece valve with a twin pilot operated check valve connected. Both cylinders, controlled by the six-way valve, are locked and stable.

Malzeme	Çelik
Vida Ölçüsü	G3/8(İsteğe Bağlı Metrik)
Sızdırmazlık Elemanı	Nitril O-ring (NBR)
Çalışma Sıcaklığı	-30°C ile 110°C Arası
Kaplama	Galvaniz + Cr+3
Isıl İşlem	Sementasyon (İç Parçalarda)
Kullanım Alanı	Kaldırma ekipmanları, vinç hidrolik sistemler üniteleri ve tarım makineleri

Material	Steel
Thread Size	G3/8 (Optional)
Sealing Element	Nitril O-ring (NBR)
Working Temperature	-30°C and 110°C
Plating	Zinc Plated + Cr+3
Heat Treatment	Case Hardened (Internal Parts)
Application	Lifting equipments, Crane Hydraulic Systems and Agricultural Machines

Stok Kodu Stock Code	Diş Ölçüsü Thread Size	Maksimum Akış Max Flow Debi lt/dk	Maksimum Basınç Max Pressure Pmax Bar
KTFD0603801	3/8"	50	350

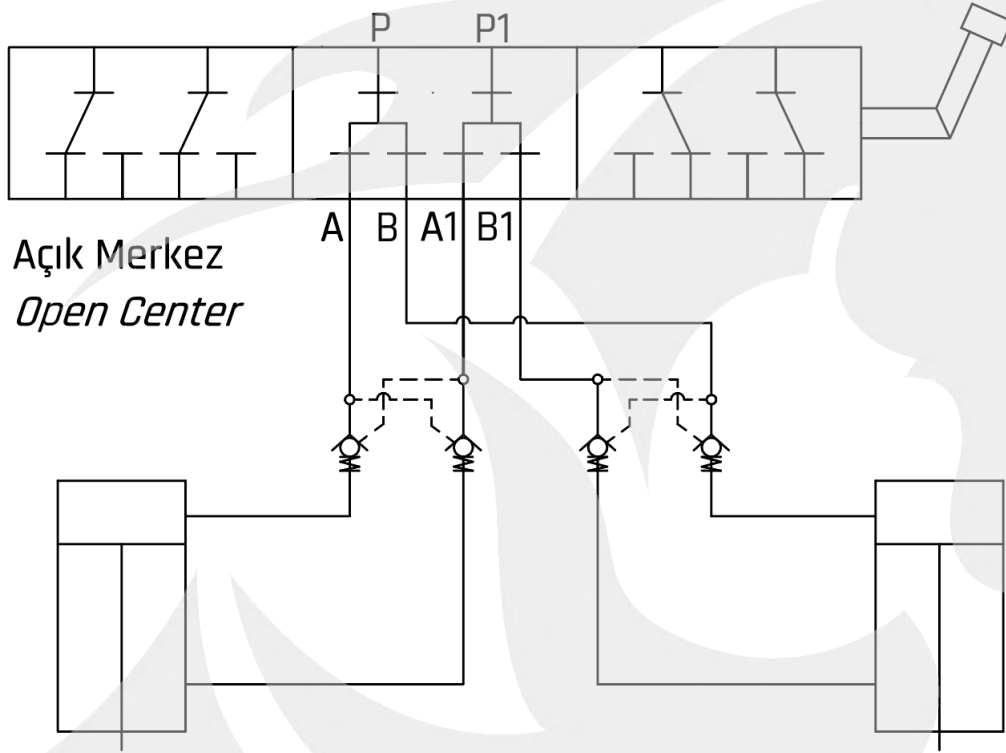

ÇEK VALF KATRİÇLERİ DİREKT BORU BAĞLANTIYA UYGUN OLACAK ŞEKİLDE ÜRETİLEBİLİR
CHECK VALVE CARTRIDGES CAN BE MANUFACTURED SUITABLY FOR DIRECT PIPE CONNECTION ON REQUEST

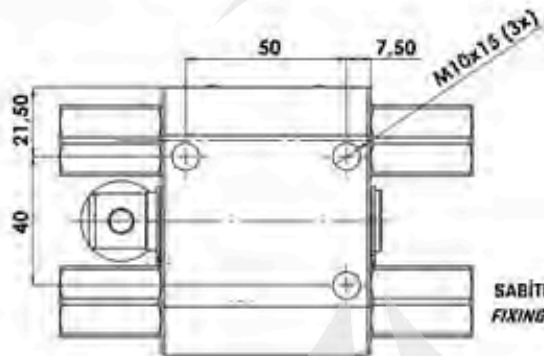
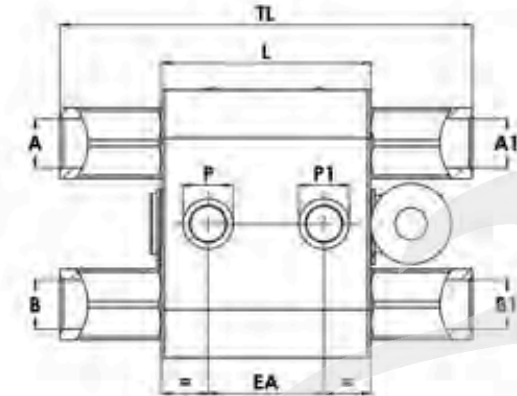

SABİTLEME ÖLÇÜLERİ TALEBE GÖRE DEĞİŞTİREBİLİR
FIXING DIMENSIONS CAN BE CHANGED ON REQUEST

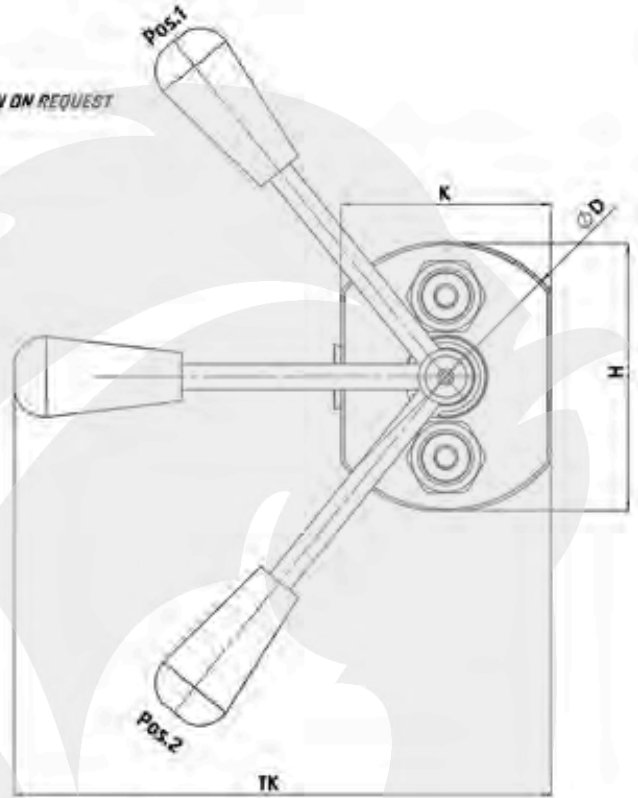

Diş Ölçüsü
Thread Size

Ölçüler
Dimensions - mm

P-P1/A-A1/B1-B2	EA	L	TL	H	K	TK	ØD
3/8"	33-36	65	128	83	65	166,5	84

*İsteğe göre G1/2" ve G3/4" ölçülerinde üretim yapılabilir.
G1/2" and G3/4" on request.





TRUCK SPARE PARTS



KLÖTZE
TECHNIC

www.klotzetechnik.de

Gesuchte Europäische
Qualität

Klötze Technic ist ein in Deutschland ansässiger Hersteller und Lieferant von LKW-, Anhänger- und Bus-Ersatzteilen.



#KLOTZETECHNIC



Oem numbers are only for comprasion and must not be mentioned on invoices

klotzetechnik.de



TRUCK SPARE PARTS



KLÖTZE
TECHNIC

www.klotzetechnik.de

Gesuchte Europäische
Qualität

Klötze Technic ist ein in Deutschland ansässiger Hersteller und Lieferant von LKW-, Anhänger- und Bus-Ersatzteilen.

FOLLOW
US

#KLOTZETECHNIC

